



Sales manual

Hansgrohe bathroom and kitchen range

**The complete guide to
Hansgrohe mixers, showers
and installation systems**

New product innovations create delight



Consumers don't just want first-class products; they also want help and advice. As your partner, we at Hansgrohe make every effort to ensure you have all the information and support you need to secure that all important sale. We offer you

innovative products and everything you need for successful consultations with your customers.

The trend is for increasingly large showers and luxurious, stylish bathrooms. Thanks to the new glass surfaces, the Rainmaker Select range integrates beautifully in the room, and the overhead shower becomes an integral design element with iconic appeal.

Another revolution awaits your customers at the basin: thanks to the new Talis Select mixers, Select technology is now also available there with intuitive operation at the touch of a button. This completes the Select range for the bathroom – or even for the complete Select household. This intuitive operating system is now available on hand and overhead showers, the shower control,

and on basin and kitchen mixers. You also have a large number of other innovations, such as the Crometta Select showers, the Crometta 100 shower line and the new Logis mixer lines, all at entry-level prices, giving you lots of new ways to delight your customers. We have also optimised this sales manual, to include a more detailed range overview to make our product offering and each product's benefits as clear and easy to follow as we can. So leading your customer through our huge range of options is as easy as 1. 2. 3. We wish you every success – and thrilled customers every day.

Yours, Richard Grohe

Be sure to use the Hansgrohe showroom app to illustrate and advise – your appealing and interactive sales aid:

- Camera function that can be used to place every product in your own bathroom
- Videos to illustrate our unique technology
- Configurator for matching basin mixer combinations
- Favorites wish list for printing out
- Search function for finding products quickly

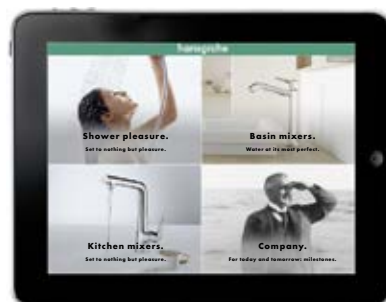

Download now for free at www.hansgrohe-int.com/catalog
or directly from iTunes at
<http://appstore.com/hansgroheshowroom>

Contents

6 Hansgrohe quality

8 Hansgrohe Select

14 Showers and shower control

16 Spray modes

18 Shower technologies

20 Large showers with Rainmaker® Select

28 Installation examples of Rainmaker® Select

38 Hand showers and shower sets

56 Overhead and side showers

70 Showerpipes

86 Showerpanel®

88 Exposed thermostats

98 Concealed finish sets/Concealed thermostats/Concealed valves

111 Concealed installation iBox® universal

116 Shower control RainBrain®

118 Installation examples of ShowerSelect®

124 Bath mixers

126 ComfortZone

128 ComfortZone test

130 Mixer technologies

134 Bathroom mixers - overview

140 PuraVida®

146 Metris®

152 Talis® Select S/Talis® S/Talis®

158 Talis® Select E/Talis® E

162 Focus®

164 Logis®

168 Metris® Classic

170 Talis® Classic

172 Logis® Classic

174 Care mixers

176 Electronic basin mixer

178 Accessories Logis®/Accessories Logis® Classic

180 Waste systems

184 Kitchen mixers

186 Kitchen mixers - overview

188 PuraVida®

190 Metris® Select/Metris®

192 Talis® Select/Talis®/Talis® Classic

194 Focus®

195 Logis®/Logis® Classic

196 Kitchen technologies

198 Company

Quality with added value



Quality borne by tradition

5 YEARS
GUARANTEE

Assured quality

SERVICE

We are there for you



Trade partner



Worldwide references

Design

Number One on the sector



Certified mixers and showers



Water processing



Saving water



Select your shower pleasure



Easy cleaning



Larger, softer drops



Optimal freedom of movement

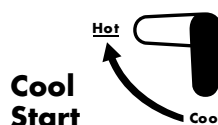

Saving energy

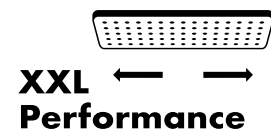

Pure shower pleasure

Find out all the latest news on water and Hansgrohe at



www.facebook.com/hansgrohe



www.twitter.com/hansgrohe_pr



www.youtube.com/hansgrohe

Impressive range for the bathroom and kitchen

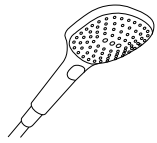

Hand showers

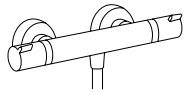

Exposed shower thermostats

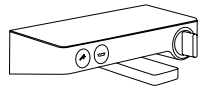

Exposed bath thermostats



Shower sets

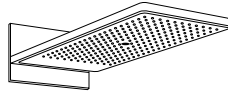

Rainmaker® Select

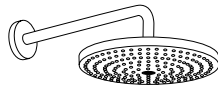

Overhead showers

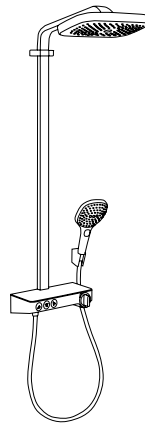

Showerpipes

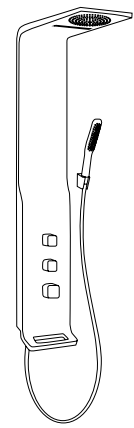

Showerpanel®

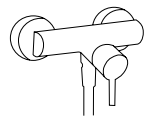

Exposed single lever shower mixers

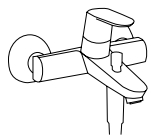

Exposed single lever bath mixers

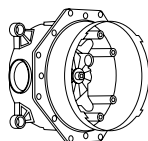

iBox® universal

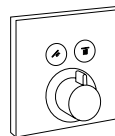

Concealed thermostats

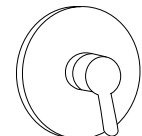

Concealed single lever shower mixers

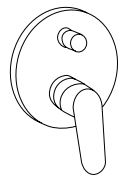

Concealed single lever bath mixers



Valves

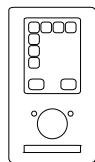

Electronic shower control

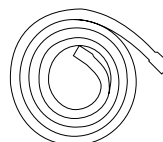

Accessories

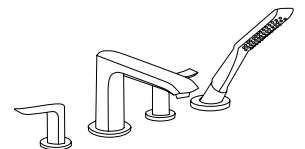

Rim-mounted mixers

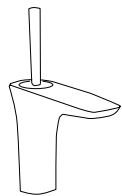

Basin mixers

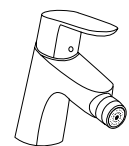
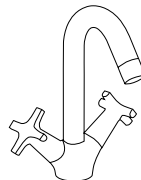
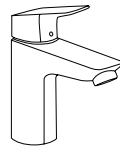
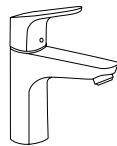
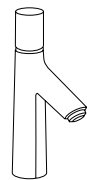
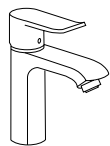

Bidet mixers



Electronic and Care basin mixers

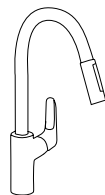
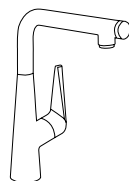
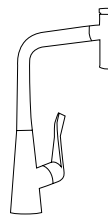
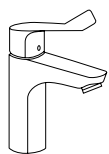

Kitchen mixers

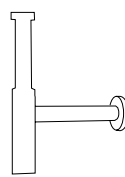

Waste systems

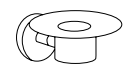

Accessories

Made by Hansgrohe

Quality you can count on: before, during and after installation

We at Hansgrohe see ourselves as retail and trade partners. Our constant ability to offer our customers the highest quality and

tailored services is a fundamental part of our corporate philosophy. No matter whether you have questions, problems, or specific wishes:

We are at your side. You can always put your trust in our quality claim "Made by Hansgrohe". Before, during and after installation.



Quality borne by tradition: We build on German expertise for the highest quality in form and function. We see, and have always seen, "Made in Germany" as a recipe for success: indeed the majority of our products are made in the Black Forest. Our goal is to offer our customers long-lasting solutions that set exceptional standards in functionality and quality. Hansgrohe only uses the highest quality materials that are approved for drinking

water applications, and they are subjected to long-term durability tests to assure their compliance with all international bathroom regulatory requirements. All single parts comply with the relevant standards and are fitted with optimal precision for safe ease of use and convenience which will last for many years to come. The guidelines we ourselves have drawn up for product safety exceed by far, most of the specifications usual in this

sector. In addition to the normal tightness tests, our showers are also tested regularly at a pressure of 10 bar. The cartridges in the fittings can even withstand pressure shocks of up to 60 bar. Test certificates from independent institutes confirm the long life and reliable use of our products. So Hansgrohe offers you quality that you can pass on directly to your customers. So you can be assured of their long-term satisfaction.

5 YEARS GUARANTEE

Assured quality: The highest quality is a fundamental part of the Hansgrohe corporate philosophy. For this reason, we offer a voluntary manufacturer's warranty of five years on all of our products.

<http://pro.hansgrohe-int.com>

CLEANING AND CARE

Customers remain happy: Our products are notable for being easy to clean. One example of this is the QuickClean function that enables limescale to be rubbed off with minimal effort. We also provide various care tips that help your customers enjoy our products for even longer.

<http://pro.hansgrohe-int.com/maintenance>

ONLINE SPARE PARTS SHOP

All parts in detail: The electronic spare parts catalogue lets you find and purchase spare and special parts with particular ease. In addition, you will benefit from other functions like dimension drawings, links between drawings and service parts, a checklist and downloads of installation and service instructions.

<http://spares.hansgrohe.com>

Hansgrohe@home

Bath planning made easy: Show your customers on your iPhone, iPad, or Android smartphone a virtual bathroom where Hansgrohe mixers and showers blend perfectly with their bathroom. iTunes: <http://appstore.com/hansgrohehome> and Google Play: <http://play.google.com/store/search?q=hansgrohe+se>

Savings Calculator

Savings with Hansgrohe: The savings calculator lets you calculate for your customers the potential saving with EcoSmart technology in mixers and showers. You can also determine the return rate on the investment: <http://pro.hansgrohe-int.com/savings-calculator> or mobile at <http://m.pro.savings.hansgrohe-int.com>

AXOR® MANUFAKTUR

Tailored products and special solutions: Besides our many standards, our factory also offers you and your customers bespoke Hansgrohe products – for single or multiple pieces. These enhance the individuality of every bathroom and lend hotel projects that unmistakable, unique and prestigious touch. <http://pro.hansgrohe-int.com/customisation>



SERVICE

Trade partner: Our experience gathered over many years offers you support in the form of a wide range of services. Whether you are in need of services, product training courses, or consultation for special projects or enhanced marketing efficiency for your services, you can only benefit from our extensive expertise. We provide a lot of information on bathroom planning online for you, such as dimension drawings and 3D details.

<http://pro.hansgrohe-int.com/service>

We are there for you: Technical questions? Our experienced master technicians will be pleased to offer you advice and support for all of your product and installation queries.

Service hours:

Mon–Fri: 07.00 am – 06.00 pm

Phone: +49 7836 51-1282

Fax: +49 7836 51-1440

Email: info@hansgrohe-int.com



Technology to thrill your customers

Once again, Hansgrohe is revolutionising the way we use water – with an elegant button. One click is all it takes to change the spray type or start or stop the water. The name of this innovative technology:

Select. An intuitive control concept at the touch of a button that promises even greater pleasure in the bathroom and kitchen. Whether hand showers, overhead showers, the ShowerTablet surface-mounted thermostat, concealed finish

sets or Showerpipes, basin or kitchen mixers – the new Select technology with its many benefits brings pleasure at the touch of a button.



Raindance® Select E 300 3jet
Overhead shower



Croma® Select S 180 2jet
Overhead shower



Raindance® Select E 300
3jet Showerpipe



Croma® Select S 180
2jet Showerpipe



Raindance® Select E 120
3jet Hand shower



Croma® Select S Vario
Hand shower



Metris® Select 320
Single lever kitchen mixer



Talis® Select 300
Single lever kitchen mixer



ShowerSelect®
Concealed thermostat



ShowerSelect® S
Concealed mixer



Talis® Select S 100
Basin mixer



Talis® Select E 110
Basin mixer



ShowerTablet® Select 300
Exposed shower thermostat

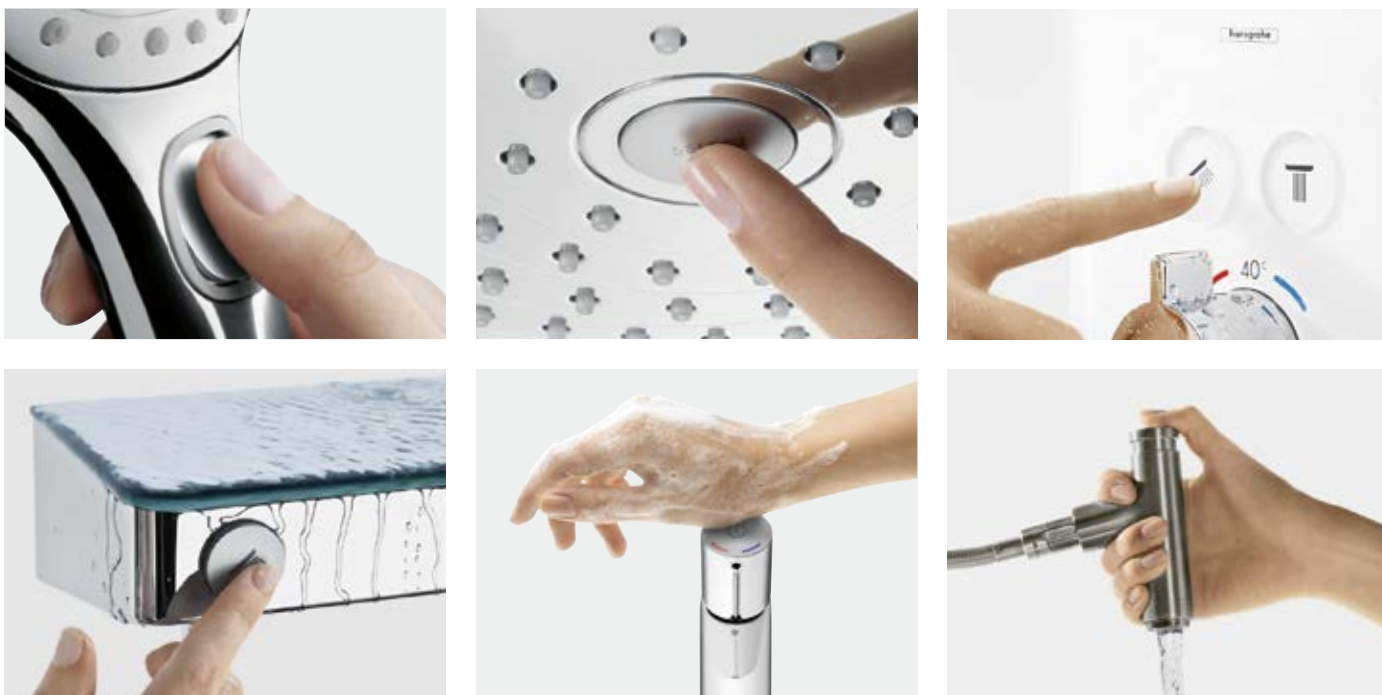

Versatile: The Select button has different functions depending on where it is being used: change between shower spray types, select the thermostat function, and start and stop the water on mixers. Depending on the particular product, the Select buttons can even be started with the back of a hand or an elbow. This makes the technology perfect for all ages, and in particular for people with limited mobility.



Advantages and benefits

- Intuitive control at the touch of a button: a simple click changes the spray type, controls a shower, and turns water on/off
- Ergonomic “universal design” allows easy and reliable use for all generations
- The clever construction complies with all Hansgrohe’s standards, and is tested for lasting durability
- A wide range of multifunctional products for a broad target group
- Consistent control solution for hand and overhead showers, Showerpipes, surface-mounted and concealed thermostats, basin and kitchen mixers

Find out more in the “Select” discussion and at
<http://pro.hansgrohe-int.com/select>

Shower solutions with Select technology



Full shower experience at the touch of a button

Select technology makes showering an even greater pleasure. It only takes a touch of a button to change the spray type or control a shower. The Select button is always mounted

so it is within easy reach while showering. With the hand shower it is on the front of the handle, with the overhead shower right in the middle of the spray face, and with surface-mounted or

concealed controls, on the front of the control unit. The technology is purely mechanical, which means it is particularly durable, inexpensive and is not complicated to install.

Select for hand and overhead showers

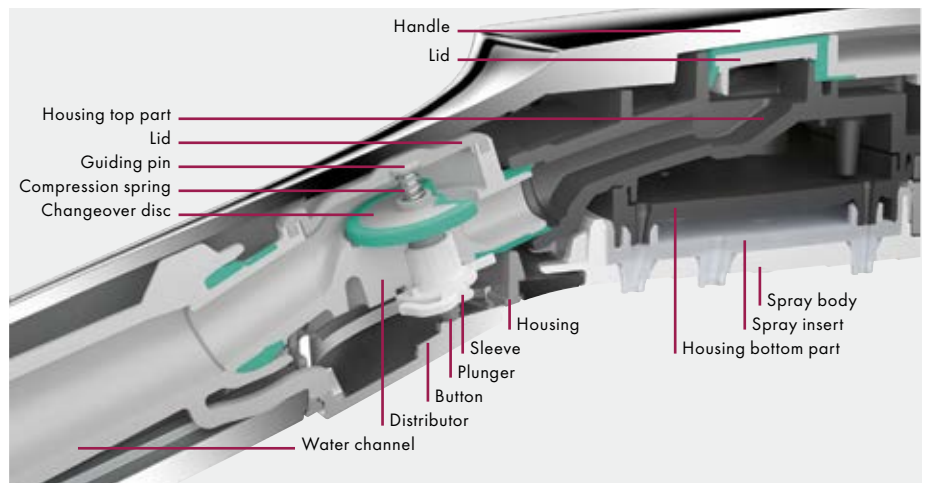

Hand showers: Thanks to the revolutionary mechanical construction, the spray can be changed, simply by touching a button. The Select button confirmed its durability in a long-term test that operated it 90,000 times.

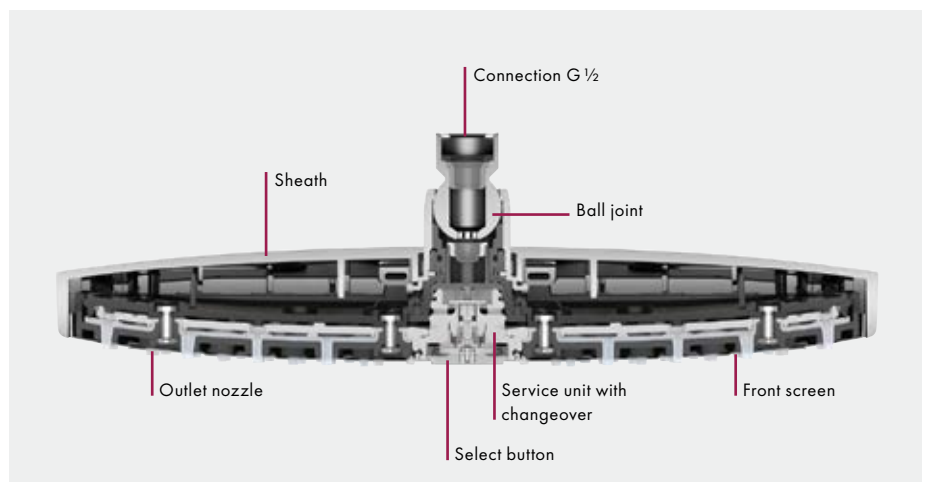

Overhead showers: The innovative changeover unit in the overhead shower makes it easy to change the spray following the Select principle. Purely mechanically, at the touch of a button.

i Hand showers with Select technology start on page 38.

i Overhead showers with Select technology start on page 56.

Select for surface-mounted and concealed controls

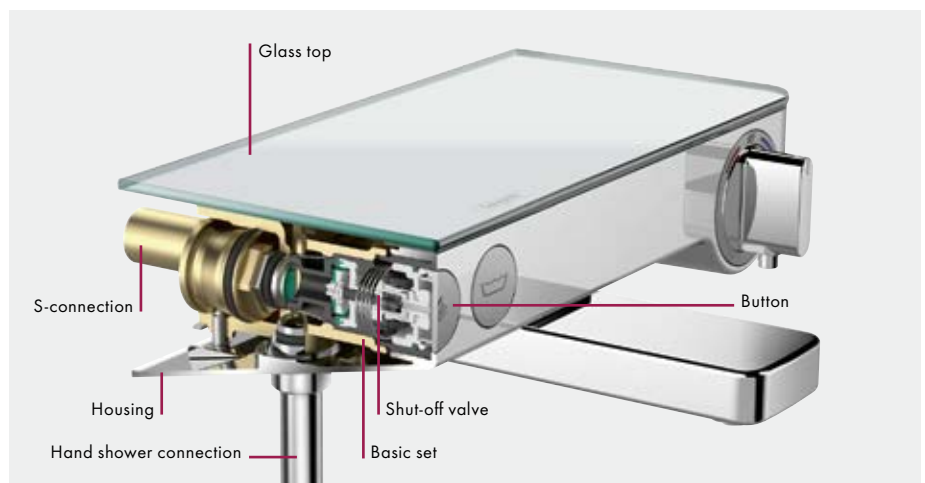

ShowerTablet/Showerpipe: Depending on the version, up to 4 functions can easily be operated by the touch of a button – even at the same time. Raised buttons indicate which function is currently active.

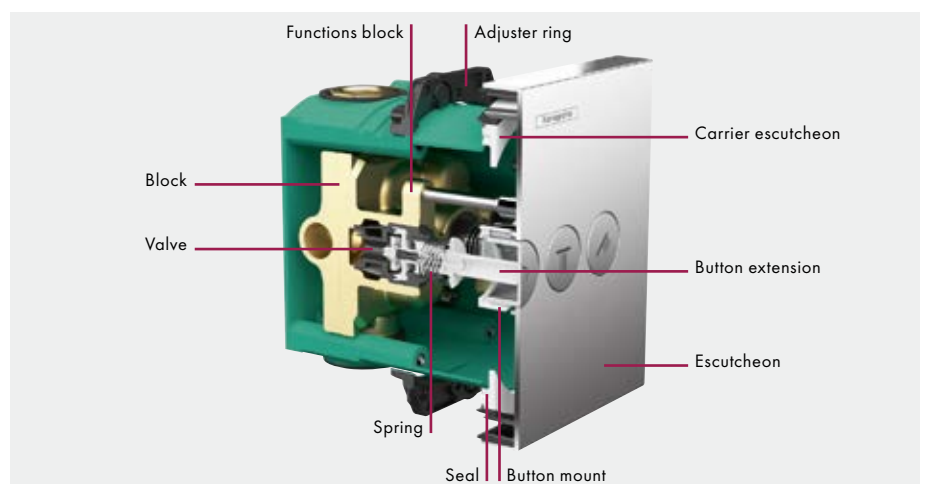

ShowerSelect finish set: Easy control of up to 4 functions at the touch of a button – even at the same time. Thanks to the optional button extension, operation is just as easy for users with limited mobility since the buttons then protrude.

Bathroom mixers with Select technology



A button that answers every question

Easy operation by Select button is now also available for the basin. A single press is all it takes, and the water starts to flow from the tap. Automatically limited to 5 l/min thanks to

EcoSmart technology. Press again, and the water stops – easy to understand and simple for every generation to use. The temperature is selected simply by turning, and remains set

after switching off. Select technology is purely mechanical. Giving your customers years of pleasure with their intuitive button.

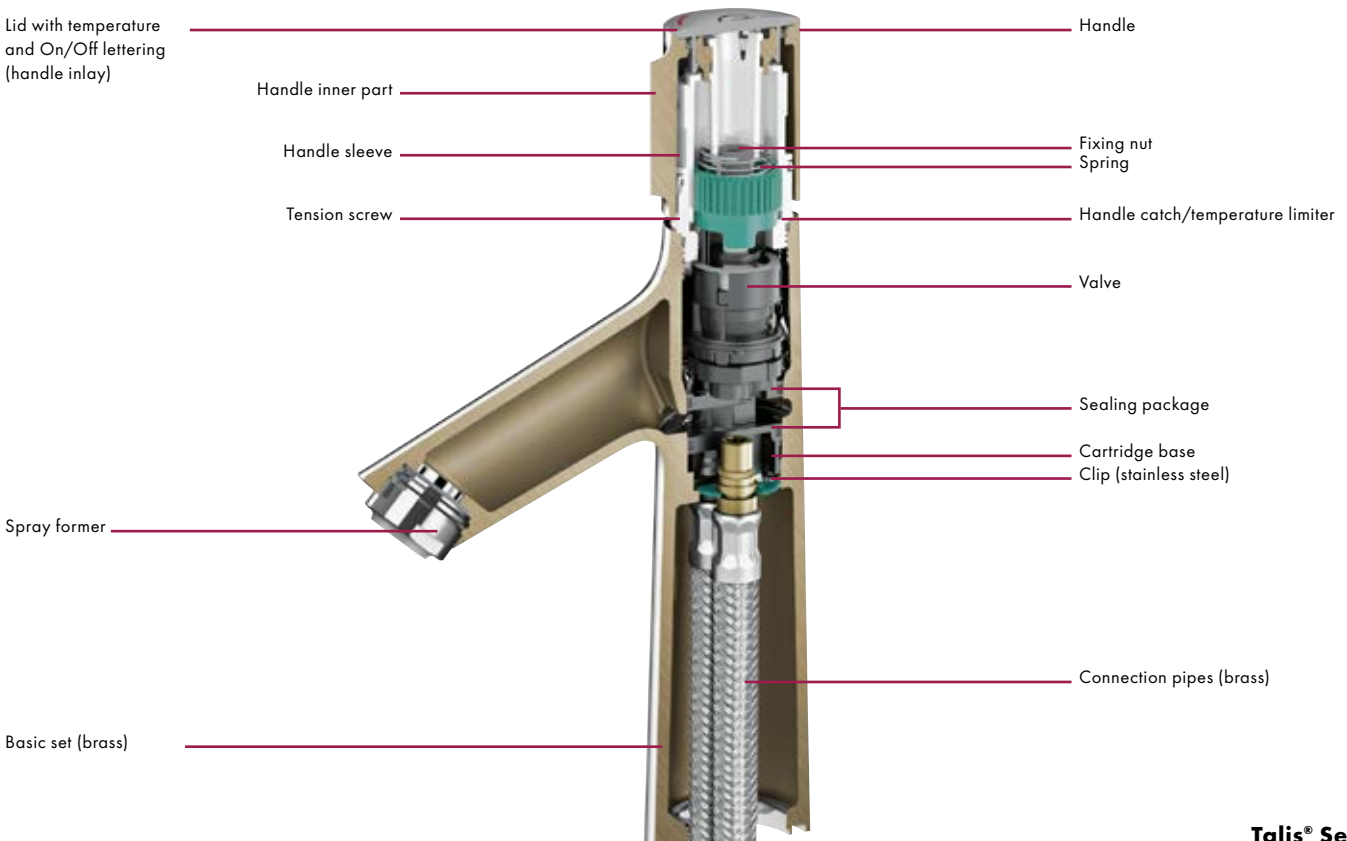

Talis® Select



Innovation: Its use is so intuitive and runs so smoothly that even children find it easy to handle. In fact, it can even be operated with an arm or elbow.



Fine form: The slender Select button facilitates an entirely new design language, opening it up to additional design-orientated target groups.



Robust: The purely mechanical Select technology has proven its durability in many challenging long-term tests.

Kitchen mixers with Select technology



A touch ahead in the kitchen

Washing, chopping, stirring – you have your hands full when you’re cooking. Which is why Select technology is also available for the kitchen. Simply turn the water spray on and off

at the touch of a button, effectively giving you a pause function. The handle remains open, and maintains the pre-set temperature and water quantity. The Select button doesn’t

interrupt the flow of work, and it makes cooking easier and more pleasurable.

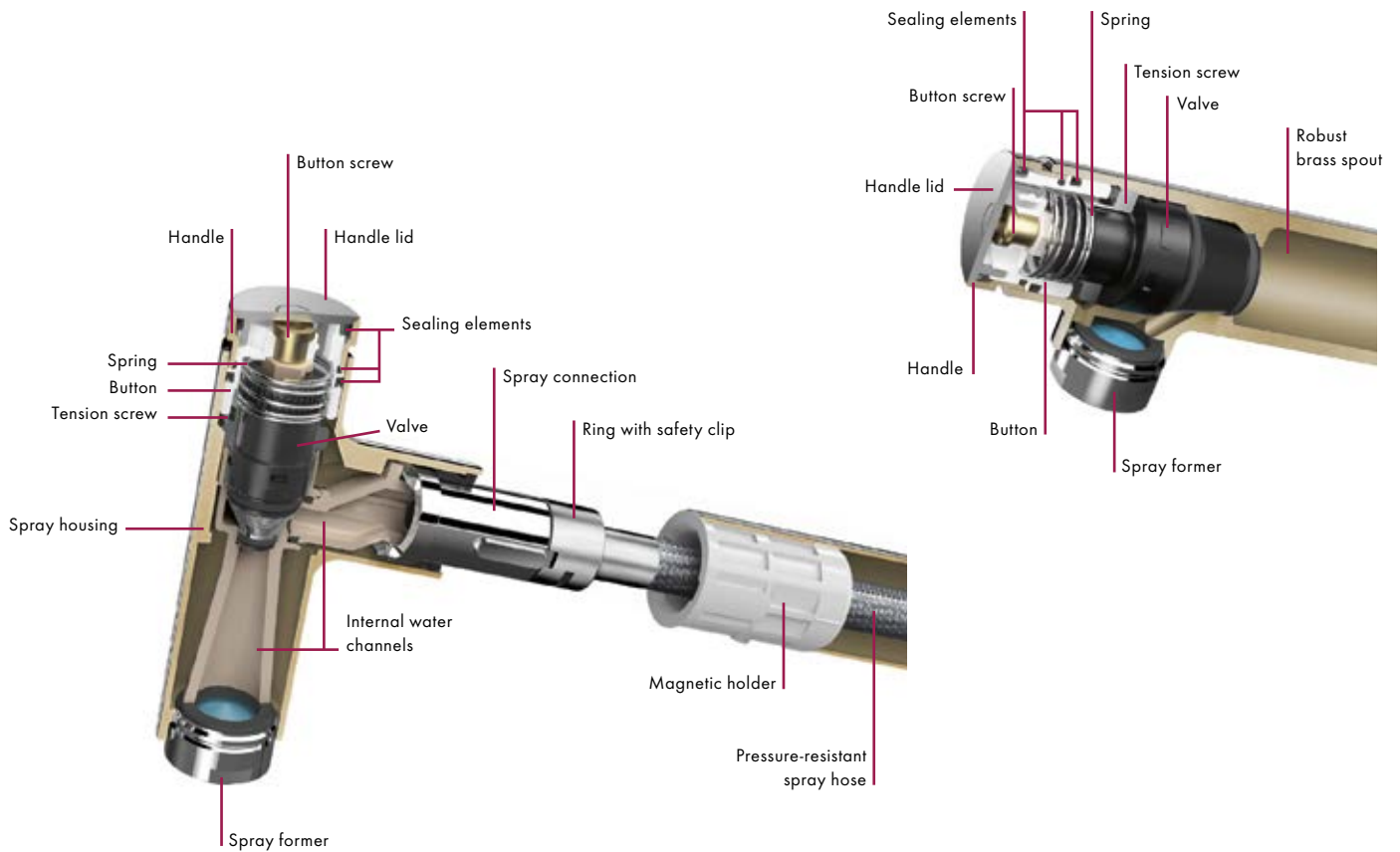

Metris® Select

Talis® Select



User-friendly: The Select button can even be operated if you have your hands full, so you can easily turn the water on and off. Which provides greater flexibility in the kitchen.



Precise: It’s even easy to fill containers beside the sink. No contortions or irritating splashes. The water is turned on and off on the pull-out spray at the touch of a button.



Robust: Whether on the pull-out spray or the 150° swivel spout, the Select button is purely mechanical, which makes it exceptionally robust.

SHOWERS AND SHOWER CONTROL

The wide range of products that fulfils all requirements:

Rainmaker® Select | Hand showers and shower sets | Overhead and side showers
Showerpipes | Showerpanel® | Thermostats
iBox® universal | Installation systems



Shower installations

As individual as your customers

When it comes to the shower, every one of your customers will want something different. But with Hansgrohe you can make all their wishes come true, we offer you a large number of shower combinations, from the simple shower and overhead shower set to the

ensemble of thermostat, hand and overhead shower. The installation options are just as flexible. Whether surface mounted or concealed, Hansgrohe provides the right solution for your needs. In addition, the Showerpipe and Showerpanel can provide

complete systems that turn a shower into something more during refurbishment work. For a larger shower area, the brand new Rainmaker Select range with large overhead showers, glass surfaces and innovative Select control will integrate perfectly.

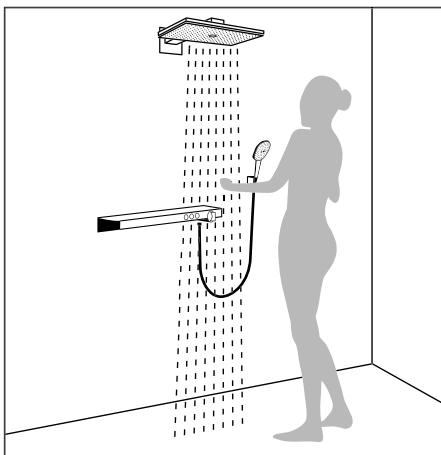

Rainmaker® Select: The individual complete solution for large showers. Large overhead showers with a glass spray face in combination with innovative mixers are an expansive showering delight. More on pages 20 and 58.



Hand shower or shower set: Even the basic solution provides pure shower pleasure for customers and moreover can be attached effortlessly to the wall. Controlled via exposed thermostat or single lever shower mixer. More on page 38 onwards.

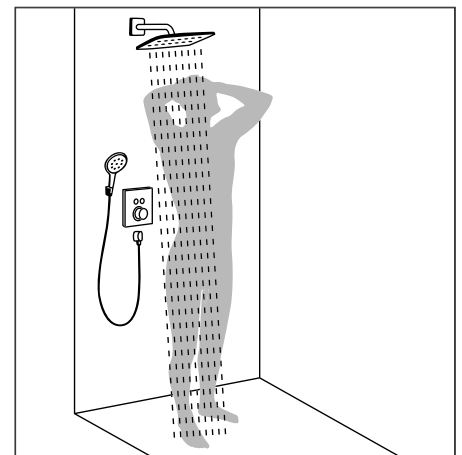

Overhead shower: For shower rain modes up to 600 mm in diameter, controlled via concealed thermostat or valves. The version with Select technology promises even greater convenience. More on pages 20 and 56 onwards.

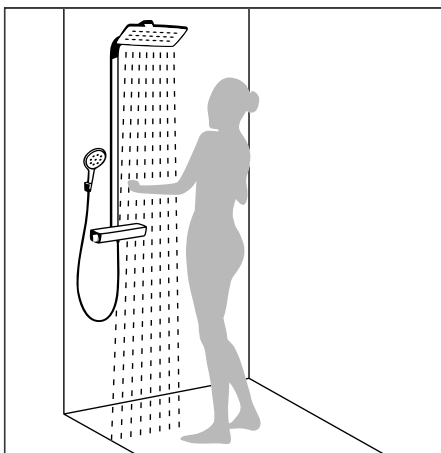

Showerpipe: The complete system with overhead shower, hand shower and thermostat. The ideal solution for uncomplicated bathroom refurbishments. More on pages 70 onwards.

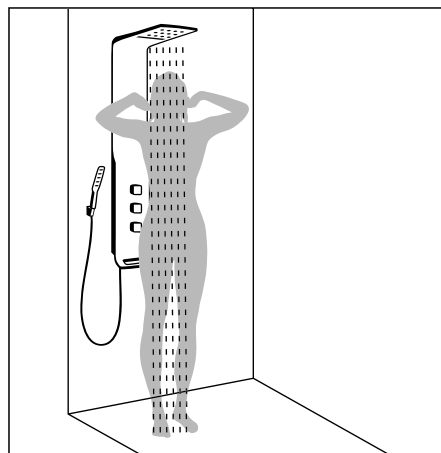

Showerpanel®: Combines overhead, hand, and/or side showers in a single system. This can be installed on existing wall connections. Hence also ideal for retrofits and refurbishments. More on pages 86 onwards.

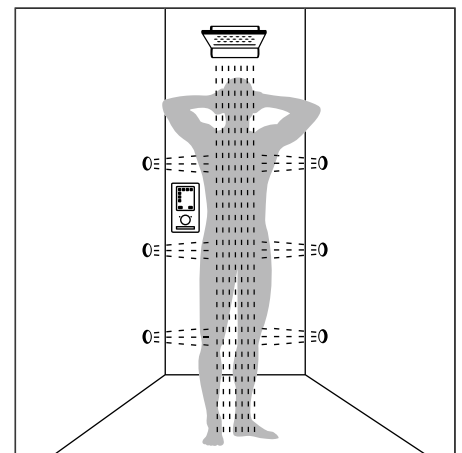

Shower family: The concealed solution for individual shower designs. From a waterfall to all-round pleasure with side showers. Controlled, for example, via the intelligent RainBrain. More on page 98 onwards.

Spray modes

Greater enjoyment with the many spray types for hand and overhead showers

Everyone showers differently, and everyone has different expectations of the perfect shower. Some think it not only as a necessity but also a way to relax. Others value

an energising, invigorating shower experience. No matter what your customers' wishes, every one of them will find the right hand or overhead shower and the right spray type in the

Hansgrohe range. The Select products promise your customers particular convenience. They can then select each spray type easily at the push of a button.



Rain and Rain XL: The openings on the hand or overhead shower may be small, but their effect is all the greater: The rain spray revitalises and refreshes with its pleasant power enveloping the body. It is therefore ideal, for example, for rinsing out shampoo quickly and thoroughly.



RainAir: If you are looking for relaxation and you want your soul to be pampered by the water. Just the right thing for this is a hand or overhead shower with the soft, luxurious RainAir spray that provides air-enriched drops from a large, wide jet, to wash your cares away.



SoftRain: The gentle SoftRain water spray gently wraps itself around the body. A treat for the skin – and for the soul, of course. Whether a daily shower or for relaxation, the SoftRain spray is always the right choice. Its strengths come into their own in a quick shower in the morning and in a long soak in the bath after a hard day.



IntenseRain: Rinsing out shampoo is easy with the strong IntenseRain water spray. Perfect for setting yourself up for the day. The IntenseRain spray not only rinses out shampoo, but it also washes morning tiredness down the drain – for a refreshing start to the day.



TurboRain: The all-purpose tool for quick results: The revitalising TurboRain spray lives up to its name. The pure power of the most powerful of all Rain sprays provides a refreshing shower experience. For those who like things to be quick and straightforward.



Mix: Gentle and dynamic at the same time. The mix spray combines the rich, soft RainAir spray with the strong, revitalising CaresseAir spray. Soft drops wrap themselves around the body, while a warm targeted water flow in the middle massages the skin. The perfect combination for daily showering pleasure.



Whirl: The concentrated Whirl spray simply washes away the exertions of the day. Whether hand or overhead shower: Three single sprays revolve around each other for an intense massage effect that dissolves tension.



Caresse Air: Five strong single sprays combine in a revitalising, strong massage spray for pleasant relaxation. Just the thing after exercise or a hard day at work – good as new in minutes.



Massage: A concentrated spray that simply washes the day's stress away. The targeted spray easily relaxes tense areas. The innovative circular arrangement of the sprays turns the shower into a mobile wellness treatment for the home bathroom.

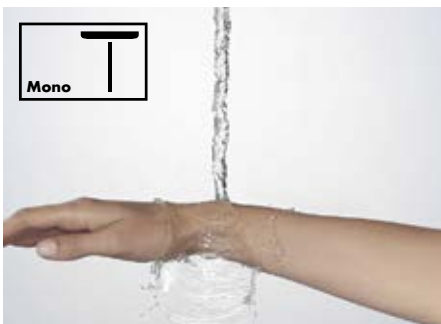

Mono: A targeted, soothing relaxation spray from the centre of the shower. The lightness of the Mono spray helps you to unwind, making it the perfect spray for relaxing.



RainFlow: An overhead shower with the clear, beautifully shaped RainFlow cascading spray brings the waterfall experience to the bathroom. This lets you enjoy water in its natural form, as a cascade from above on the neck and shoulders. This can be directed specifically to these parts of the body and tension quickly disappears. This is a trend especially in the wellness bathroom.



RainStream: The new RainStream of single sparkling jets is a crowning achievement of the Hansgrohe spray developers. These special overhead shower sprays do not constrict, but remain unvaryingly revitalising and intense right down to the floor. The result: a new, revitalising shower experience, irrespective of the users height.



AirPower: more volume, more pleasure

Convenience and efficiency don't have to be mutually exclusive. This is proved by Hansgrohe AirPower showers. This technology developed by Hansgrohe involves drawing in

air over the whole area of the spray face. Water can then be used with greater efficiency. At the same time, the drops are fuller, lighter and softer. The result can be felt immediately

on the skin: The sparkling AirPower shower rain envelops the body and generates a magnificent well being.



AirPower: The generous injection of air gives rise to extraordinary shower pleasure and large, luxurious shower drops.



Advantages and benefits

- Fuller, lighter and softer drops - pure shower pleasure
- Fewer splashes, so less cleaning
- Larger water volume for greater water efficiency

QuickClean: fast anti-limescale function

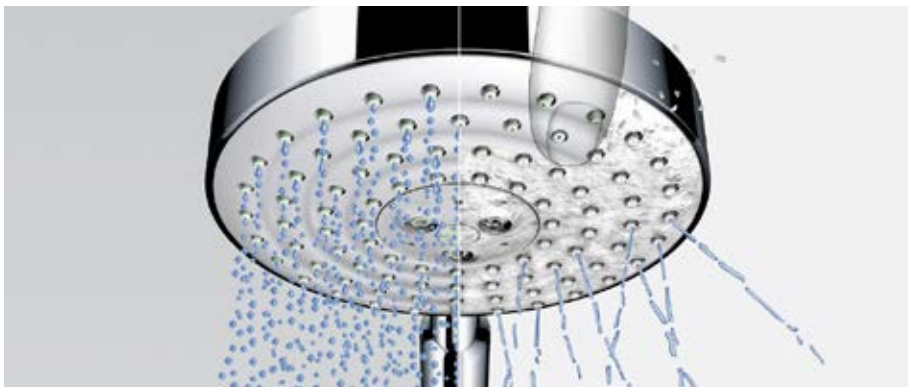

QuickClean: Thanks to the flexible silicone jets, dirt and limescale simply wipe away with a finger.



Advantages and benefits

- Fast and easy cleaning
- Ultra high quality and tear resistant silicone
- For a long lifetime and functionality

XXLPerformance: great shower pleasure

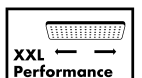

XXLPerformance: The generously-proportioned shower experience with air-enriched, lavish drops and the surprisingly low water consumption.



Advantages and benefits

- Shower rain modes up to 600 mm in diameter
- High water efficiency - a uniformly distributed spray for an incomparable showering experience



Select: showering pleasure at the touch of a button.

It is easier to push than to turn. The innovative Select technology transfers this thought to the hand and overhead showers and the shower control. With an elegant button that only requires a single click to change the spray type or control the water. For even greater

pleasure when showering – for all ages.



Select: Operation at the touch of a button on hand and overhead showers, Showerpipes and surface-mounted and concealed thermostats provide even more comfort.



Advantages and benefits

- Intuitive control at the touch of a button
- More comfort for every generation
- Mechanical construction for permanent functional safety

EcoSmart: water and energy savings



Hansgrohe EcoSmart showers consume up to 60% less water than conventional products. This reduces water and energy costs and protects valuable resources, which is confirmed by the best possible rating of our hand showers Crometta 85 Green and Croma

100 (1jet, Vario, and Multi) by the European quality mark WELL – Water Efficiency Label.



EcoSmart: The ingenious flow rate limiter in the shower reduces water consumption to only 9 or 6 l/min.

WELL Upgrade Volume Water Efficiency Label	
Manufacturer:	Hansgrohe SE
Product category:	Accessories shower valve
Type:	Shower head
Model:	Crometta 85 Green
Registration number:	ZD1056420130704
<div style="display: flex; justify-content: space-between;"> <div> <p>A</p> <p>B</p> </div> <div style="border: 1px solid black; padding: 2px;"> <p>A**</p> </div> </div>	
<p>Water Efficiency Criteria</p> <p>Flow rate > 9.0 l/min ≤ 12.0 l/min * Controlled flow rate ≥ 4.5 l/min ≤ 9.0 l/min **</p>	
<p><small>Information about use and installation: www.wellonline.eu. A Label of EU United Values European Valve Manufacturers Association</small></p>	



Advantages and benefits

- Up to 60% less water consumption
- Hot water savings for less energy consumption – so less CO₂ emissions and lower costs



How much water and energy can be saved is calculated by the savings calculator at:

<http://pro.hansgrohe-int.com/savings-calculator>



Extra-large showering pleasure

A clear trend is becoming obvious in the modern bathroom: The bath is becoming less important, while the shower area is becoming bigger and the centre of the bathroom. At the same time, the desire for homeliness, freedom

of movement and lasting material quality is growing. Meet these increased requirements with the new Rainmaker Select overhead showers and visually matching control elements. Spray widths of up to 580 mm,

elegant glass surfaces and integrated storage surfaces or control at the touch of a button make the extended shower room something very special. For extra-large showering pleasure.



Complete: From overhead showers with spray widths of up to 580 mm, to intelligent concealed controls and Showerpipes to the first surface-mounted thermostat that also controls single-spray overhead showers to G ½ wall connections, the new complete system for large showers provides your customers with fabulous balanced solutions.

Concealed installation:



Rainmaker® Select overhead showers



ShowerSelect® concealed thermostats

Surface-mounted installation:



Rainmaker® Select Showerpipes

Surface-mounted/concealed installation:



Rainmaker® Select overhead showers



ShowerTablet® Select 700

Glass – the connecting element in large showers

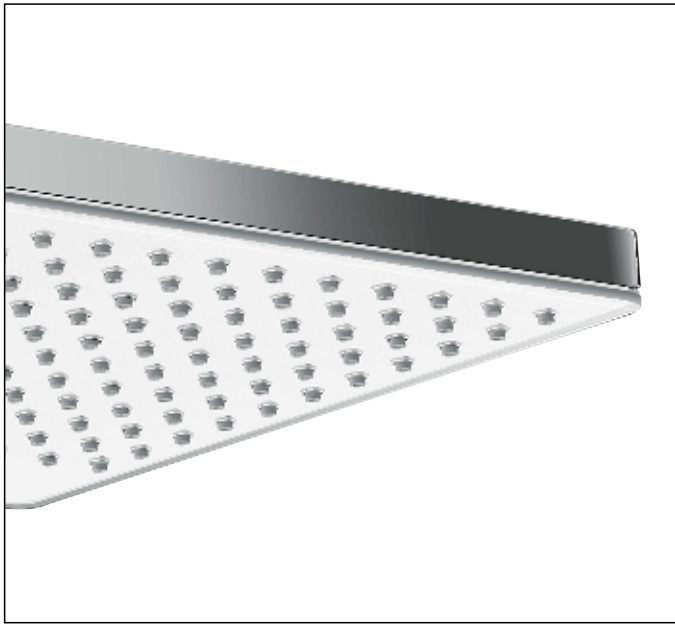

A highlight in the bathroom: Glass is the most natural material to go with water. There's a good reason why we prefer to use glass bottles and glasses for refreshment. Glass appeals because of its elegant, precise looks, and appeals with other advantages such as hygiene, scratch resistance and being easy to clean. It can cope with any chemical cleaners, which makes it perfect for hotels. In the Rainmaker Select range, glass is the central design feature. This provides harmonious

links with other bathroom elements in large and small shower areas. On the one hand, with glass objects such as mirrors or shower partitions, and on the other with the white/chrome colouring that goes happily with PuraVida products. Close attention is paid to every detail in production to ensure the attractive appeal. Lasering and burning the glass are both signs of excellent quality – quality that can be seen and felt with every shower.



Advantages and benefits

- Cleverly designed spatial range for large showers
- Matching colours and design language for a harmonious bathroom ambience
- Comfortable ambience thanks to exclusive, long-lasting materials such as glass and chrome-plated metal
- Special architectural design appeals to more design conscious customers

Rainmaker® Select overhead showers

NEW

The new star in the shower sky

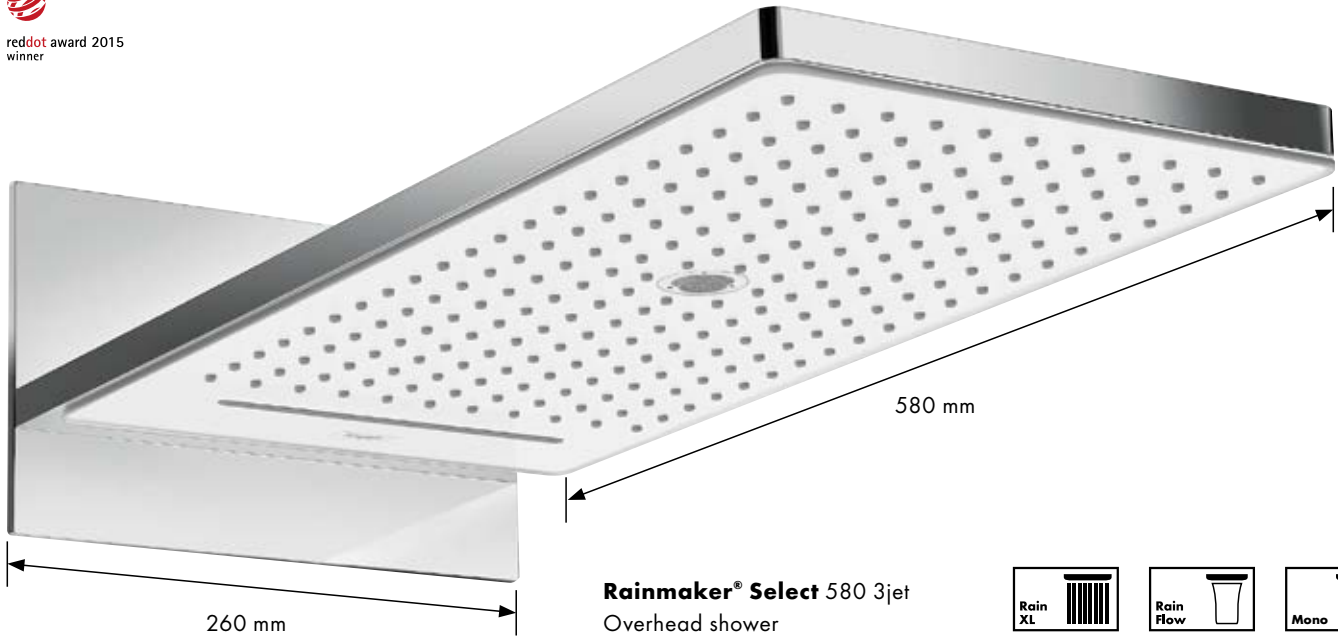

Rainmaker® Select 580 3jet
Overhead shower



Exclusive: Safety glass surface with lasered spray openings.



Mono: A targeted spray for showering pleasure that also refreshes.



RainFlow: A full flood spray for a refreshing shower.



Advantages and benefits

- Unique: Glass spray faces in impressive sizes
- Spray widths of up to 580 mm perfectly fill the large shower area
- Height-variable wall mounting based on the iBox universal for optimum spray intensity of RainFlow or RainStream
- The generous proportions of the overhead shower make it a prominent feature in the bathroom
- Generous white surfaces integrate harmoniously in the ceiling, and look light and elegant

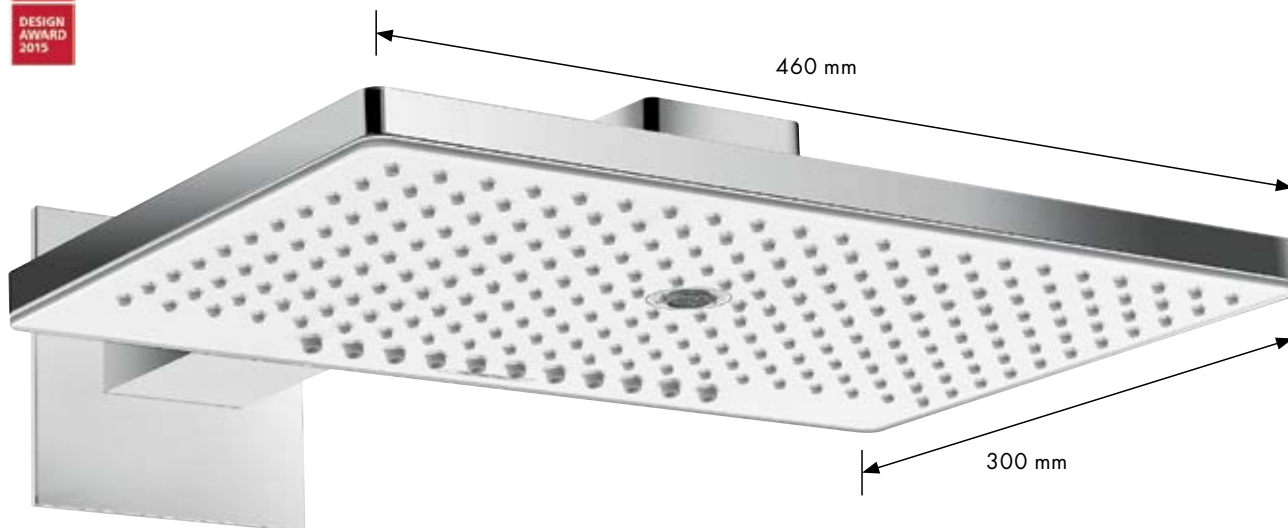

Rainmaker® Select 460 3jet
Overhead shower



Flexible: Also available for ceiling mounting, where it can be positioned freely anywhere in the room.



Easy cleaning: Thanks to the QuickConnect holder, the overhead shower can easily be fitted or removed for cleaning by one person - no tools required.

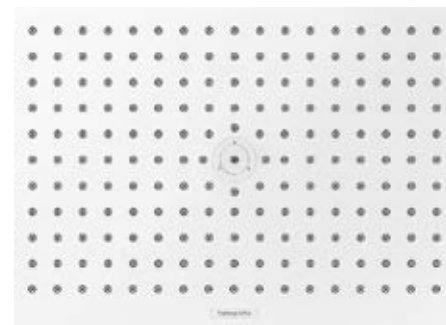

Permanent: The spray face is cut by laser, the colour and lettering applied to the back and permanently fused to the glass.

- **Easy to clean,** durable and a high level of hygiene thanks to the level, hard surface in 4 mm safety glass
- Choice of versions with 1-3 spray types
- New surface-mounted/concealed installation of the single-spray overhead shower also possible with ShowerTablet Select 700. The storage surface is built in.
- Also available in the EcoSmart version with only 9 l/min

ShowerSelect® Concealed thermostat

Glass and comfort in harmony

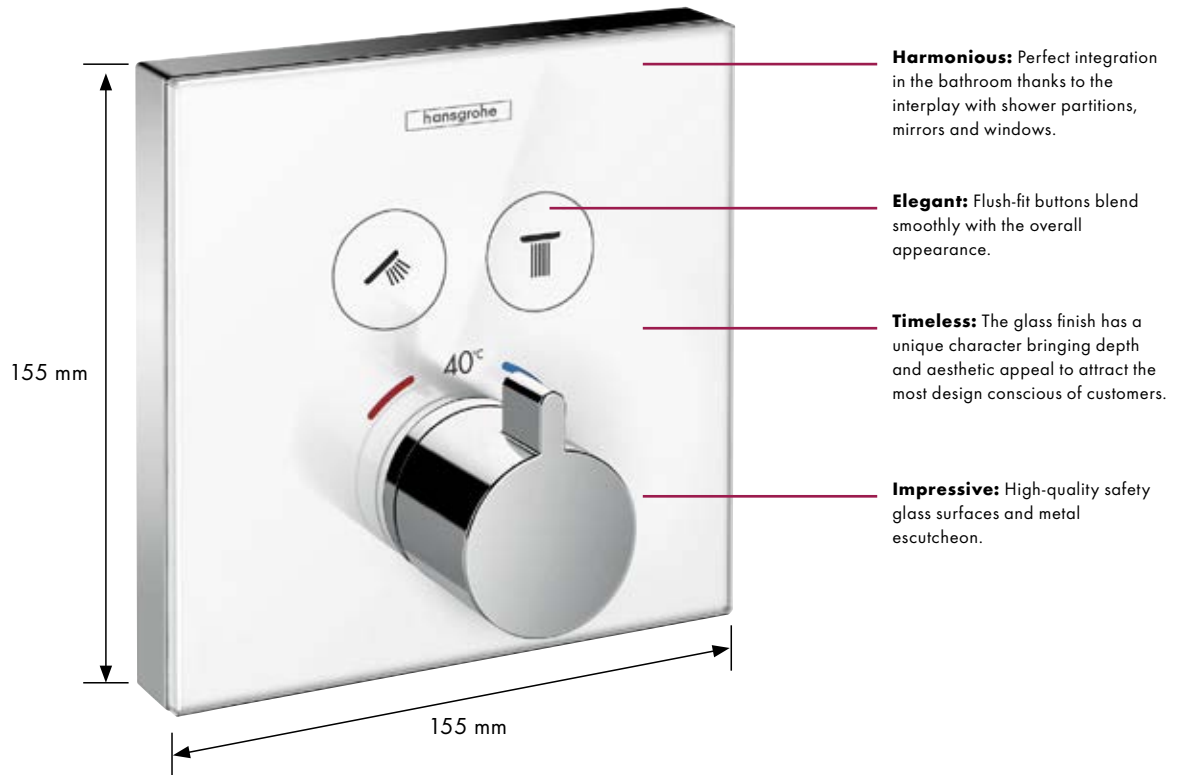

Harmonious: Perfect integration in the bathroom thanks to the interplay with shower partitions, mirrors and windows.

Elegant: Flush-fit buttons blend smoothly with the overall appearance.

Timeless: The glass finish has a unique character bringing depth and aesthetic appeal to attract the most design conscious of customers.

Impressive: High-quality safety glass surfaces and metal escutcheon.



Intuitive: Easy-running Select buttons provide operation at the touch of a button for any generation.



User-friendly: Slim pin handle with an eye-catching temperature display for easy, comfortable setting of the desired temperature.



Easy cleaning: Cleaning is as easy as ABC thanks to the smooth glass surface and precision shapes.



Advantages and benefits

- Solutions available for 1-4 functions
- Looks match the Rainmaker Select showers for a harmonious bathroom ambience
- Also easy to combine with chrome showers
- Refurbishment is quick and easy, simply by exchanging the existing finish sets directly on the iBox universal
- Functions can be switched off quickly and easily to save water

ShowerTablet® Select 700 surface-mounted/concealed thermostat

More space for pleasure

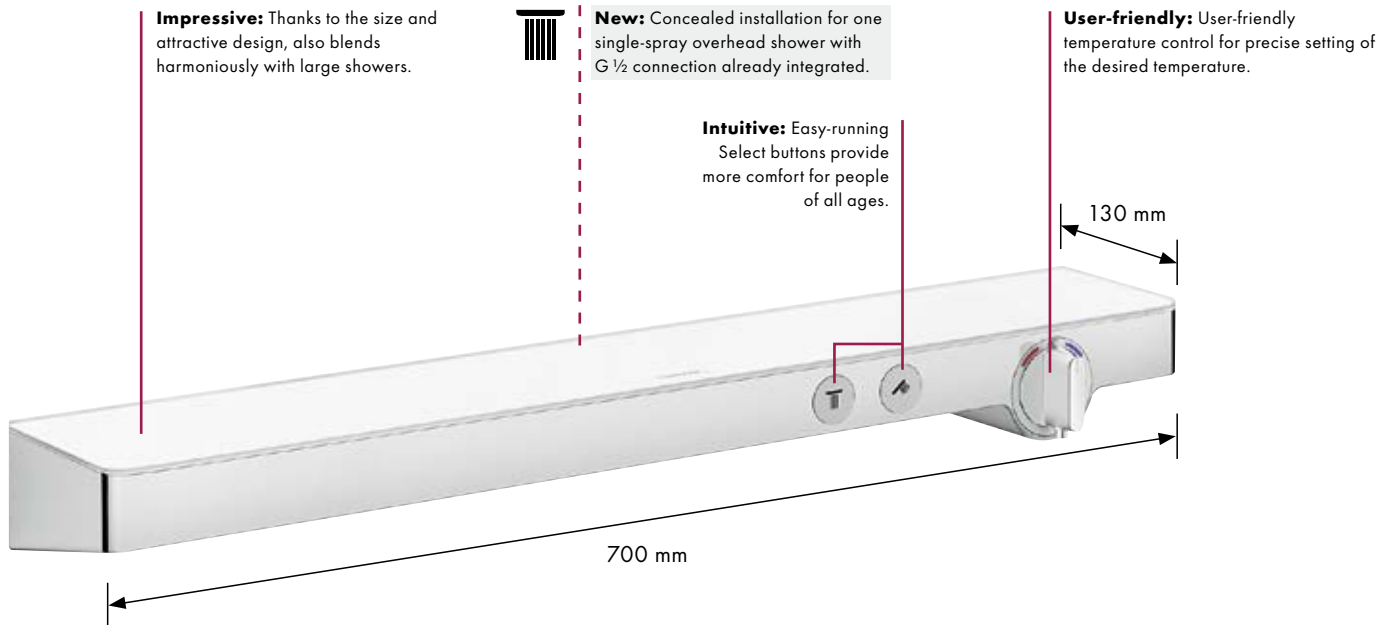

Generous: 700 mm wide shelf made of safety glass for more storage space.



Flexible: The ShowerTablet Select is also available as a bath version.



Advantages and benefits

- Hansgrohe's first surface-mounted thermostat to control a single-spray overhead shower via concealed installation (G ½)
- Plenty of storage space thanks to the 700 mm width
- Visual highlight and easy to clean thanks to the high-quality glass surface
- Functions change easily at the touch of a button, symbols easy to understand

Rainmaker® Select 460 3jet Showerpipe

For deluxe showering pleasure



Easy cleaning: High-quality glass surface, completely even and so easy to clean.



Select
Easy operation of the hand shower and spray types at the touch of a button



Mono: A targeted spray for showering pleasure that also refreshes.



Rain XL: Rain spray over the entire area of the spray face for large-scale showering pleasure.



RainStream: Eleven jets of sparkling water that run parallel right down to the floor. For the same fascinating shower effects at every installation height so you enjoy the same refreshing shower however tall you are.



Select
Select the spray types

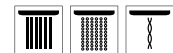

Setting the temperature



Advantages and benefits

- Different versions with different overhead showers for complete showering pleasure in large showers
- Intuitive control concept, pleasure at the touch of a button
- Practical 700 mm wide storage shelf
- **Easy to clean** thanks to the large, even surfaces
- Easy installation with the thermostat, overhead and hand showers in a single system
- Ideal for modernisations, since it can be fitted to existing wall connections and for large shower areas



Installation 2 functions

ShowerTablet® Select 700 with 1 spray overhead shower Rainmaker® Select 460 1jet and Raindance® Select S 120 3jet hand shower



Components

Mixers

- Ⓑ Thermostat ShowerTablet Select 700 # 13184, -400

Showers

- Ⓐ Overhead shower Rainmaker Select 460 1jet # 24003, -400
- Ⓒ Hand shower Raindance Select S 120 3jet # 26530, -400 Porter 'S shower holder # 28331, -000
- Ⓓ Isiflex shower hose # 28271, -000
- Ⓔ Raindrain XXL waste system # 60067, -000

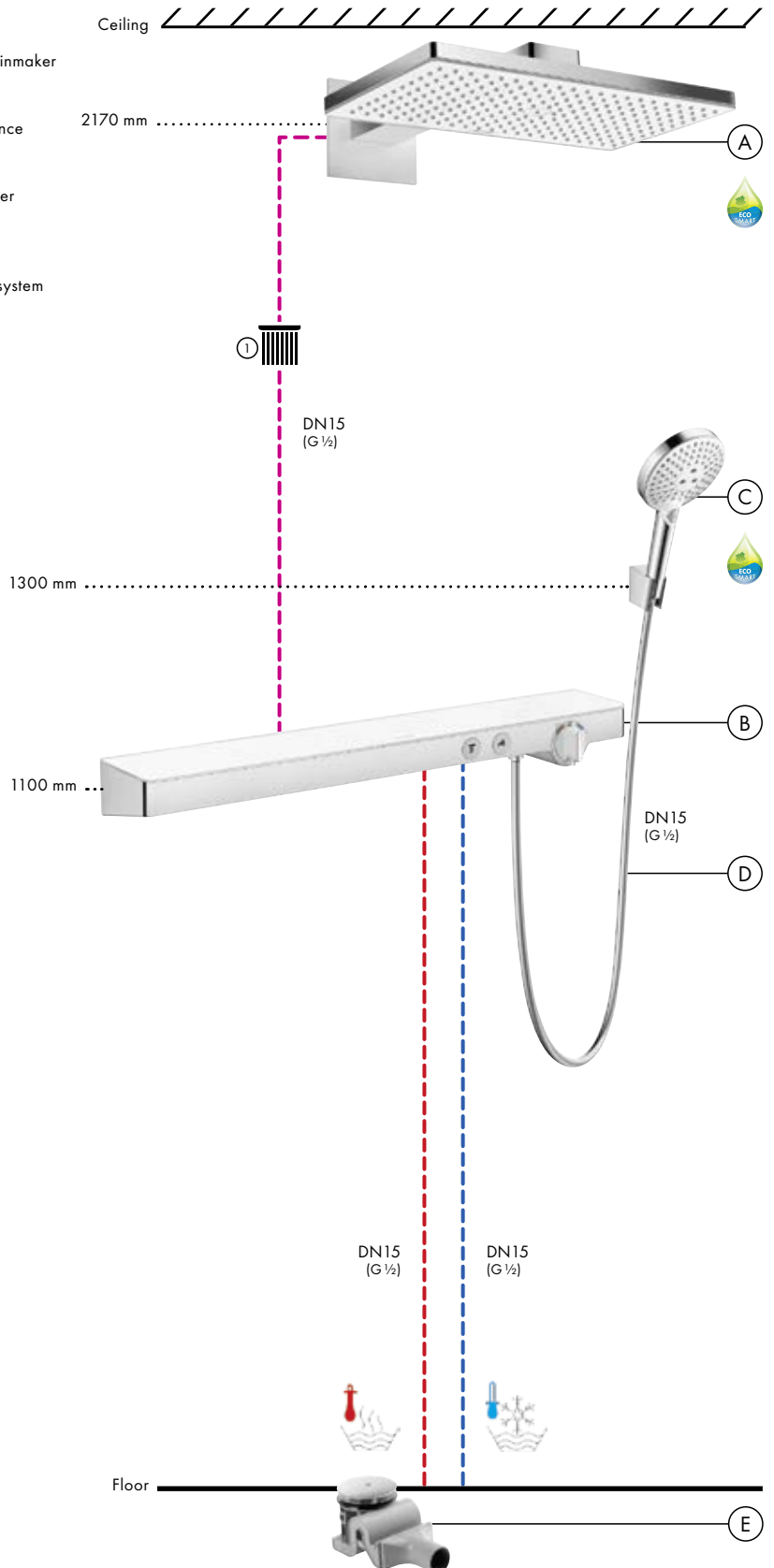

Flow diagram

Overhead shower Rainmaker Select 460 1jet # 24003, -400

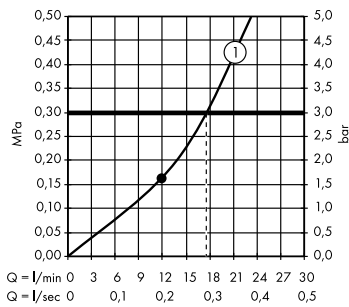

Flow diagram

Hand shower Raindance Select S 120 3jet # 26530, -400

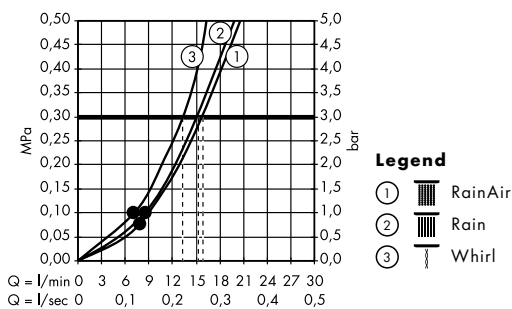

• denotes minimum operating pressure

Installation 2 functions

ShowerSelect® thermostat concealed with 1 spray overhead shower Rainmaker® Select 460 1jet and Raindance® Select S 120 3jet hand shower



Components

Mixers

- (B) Basic set iBox universal
#01800180
Thermostat ShowerSelect
for 2 functions
#15738, -400

Showers

- (A) Overhead shower Rainmaker
Select 460 1jet
#24003, -400
- (C) Hand shower Raindance
Select S 120 3jet
#26530, -400
Porter 'S shower holder
#28331, -000
- (D) Isiflex shower hose
#28271, -000
Shower connection Fixfit Square
#26455, -000
- (E) Raindrain XXL waste system
#60067, -000

Flow diagram

Overhead shower Rainmaker Select 460 1jet
#24003, -400

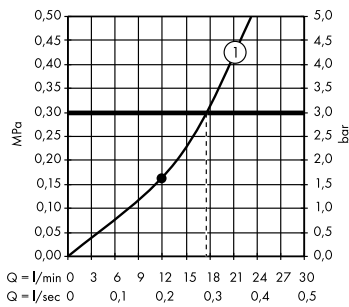

Legend

- (1) Rain XL

Flow diagram

Hand shower Raindance Select S 120 3jet
#26530, -400

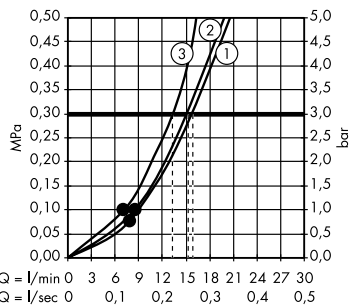

Legend

- (1) RainAir
- (2) Rain
- (3) Whirl

• denotes minimum operating pressure

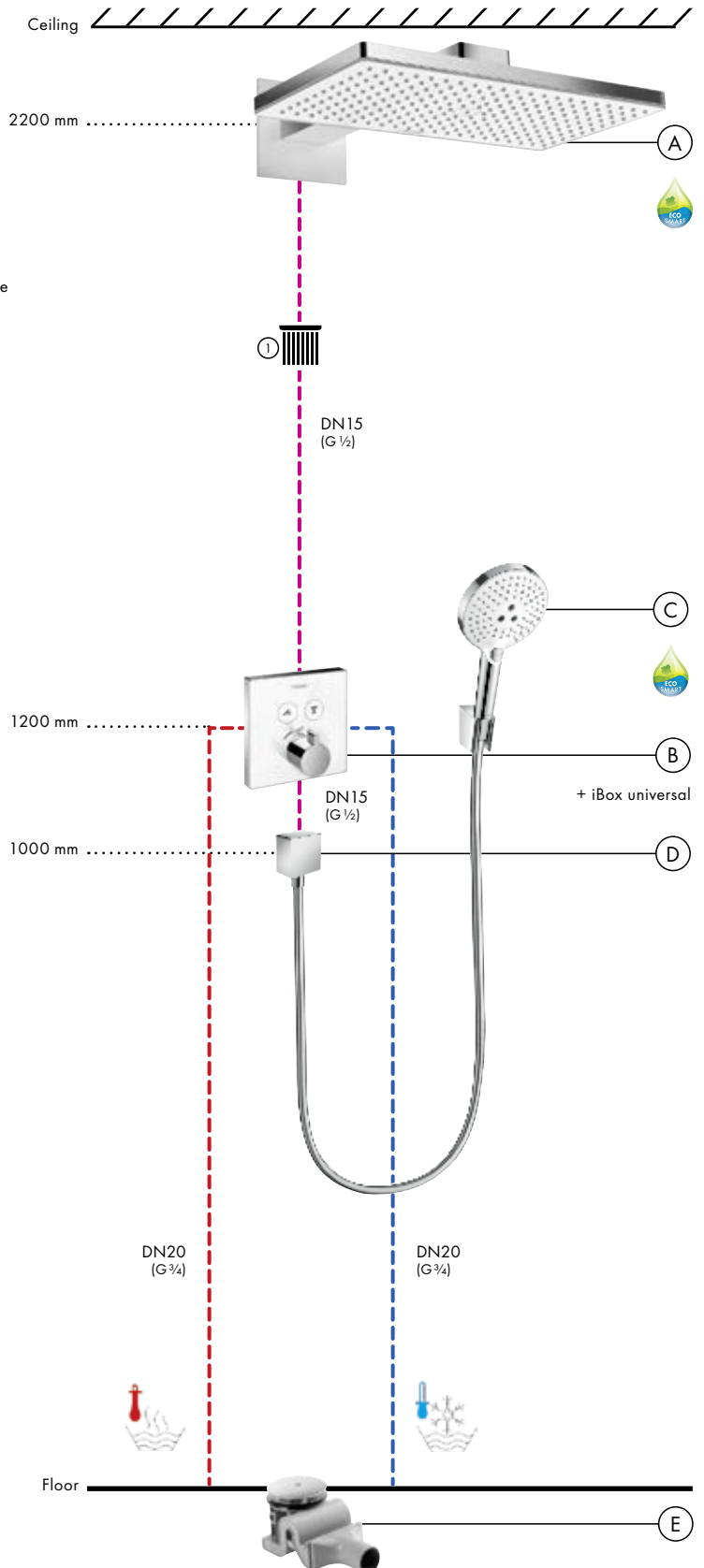

Installation 3 functions

ShowerSelect® thermostat concealed with 2 spray overhead shower Rainmaker® Select 460 2jet and Raindance® Select S 120 3jet hand shower



Components

Mixers

- (C) Basic set iBox universal
01800180
Valve ShowerSelect for 3 functions
15736, -400
- (D) Basic set iBox universal
01800180
Highflow Thermostat ShowerSelect
15734, -400

Showers

- (A) Basic set iBox universal
01800180
Overhead shower Rainmaker
Select 460 2jet
24005, -400
- (B) Hand shower Raindance
Select S 120 3jet
26530, -400
Shower holder/Shower connection
Fixfit/Porter Square
26486, -000
Isiflex shower hose
28271, -000
- (E) Raindrain XXL waste system
60067, -000

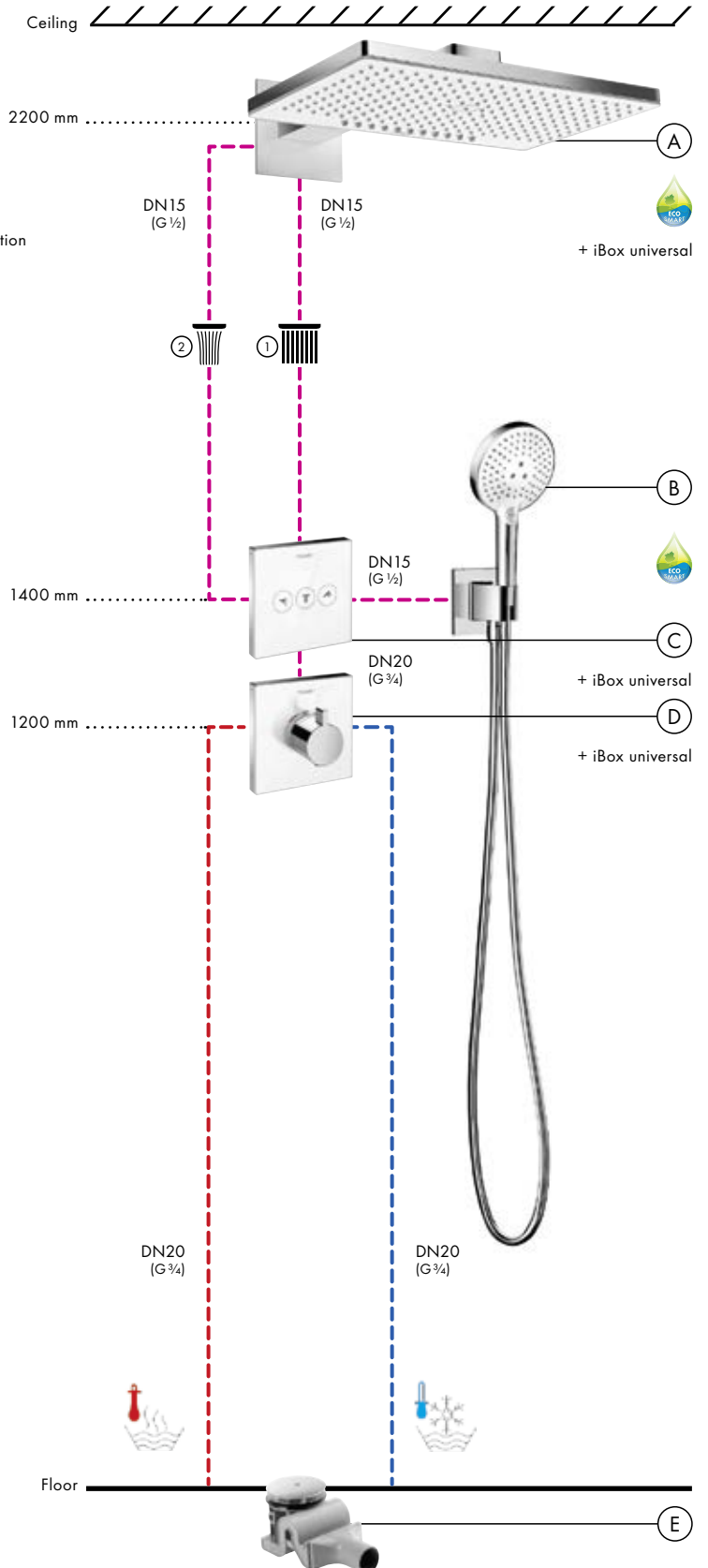

Flow diagram

Overhead shower Rainmaker Select 460 2jet
24005, -400

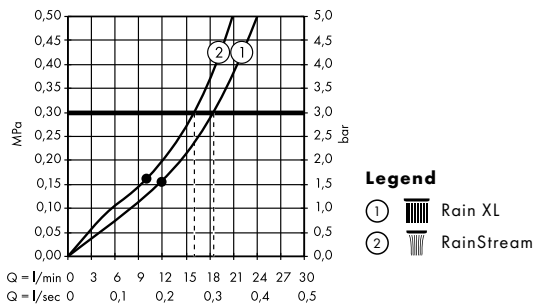

Flow diagram

Hand shower Raindance Select S 120 3jet
26530, -400

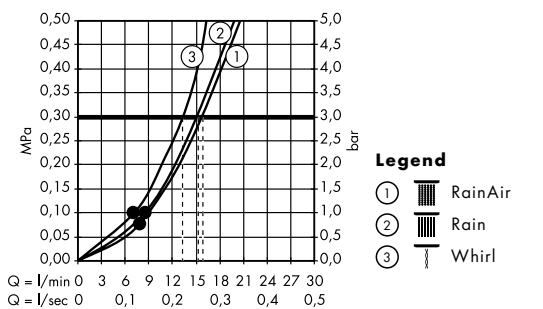

• denotes minimum operating pressure

Installation 4 functions

ShowerSelect® thermostat concealed with 3 spray overhead shower Rainmaker® Select 580 3jet and Raindance® Select S 120 3jet hand shower



Components

Mixers

- (C) Basic set iBox universal
#01800180
Valve ShowerSelect for 3 functions
#15736, -400
- (D) Basic set iBox universal
#01800180
Highflow Thermostat ShowerSelect
for 1 function (top) and one
additional function (bottom)
#15735, -400

Showers

- (A) Basic set iBox universal
#01800180
Overhead shower Rainmaker
Select 580 3jet
#24001, -400



- (B) Hand shower Raindance
Select S 120 3jet
#26530, -400
Porter 'S shower holder
#28331, -000
Isiflex shower hose
#28271, -000
- (E) Shower connection Fixfit Square
#26455, -000
- (F) Raindrain XXL waste system
#60067, -000

Flow diagram

Overhead shower Rainmaker Select 580 3jet
#24001, -400

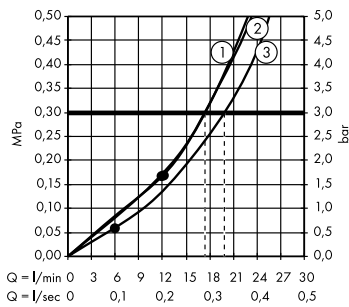

Legend

- (1) Rain XL
- (2) RainFlow
- (3) Mono

Flow diagram

Hand shower Raindance Select S 120 3jet
#26530, -400

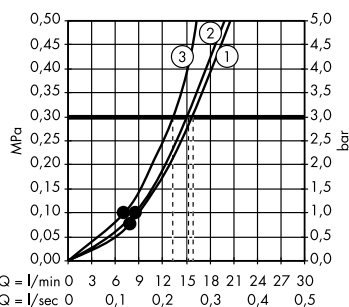

Legend

- (1) RainAir
- (2) Rain
- (3) Whirl

• denotes minimum operating pressure

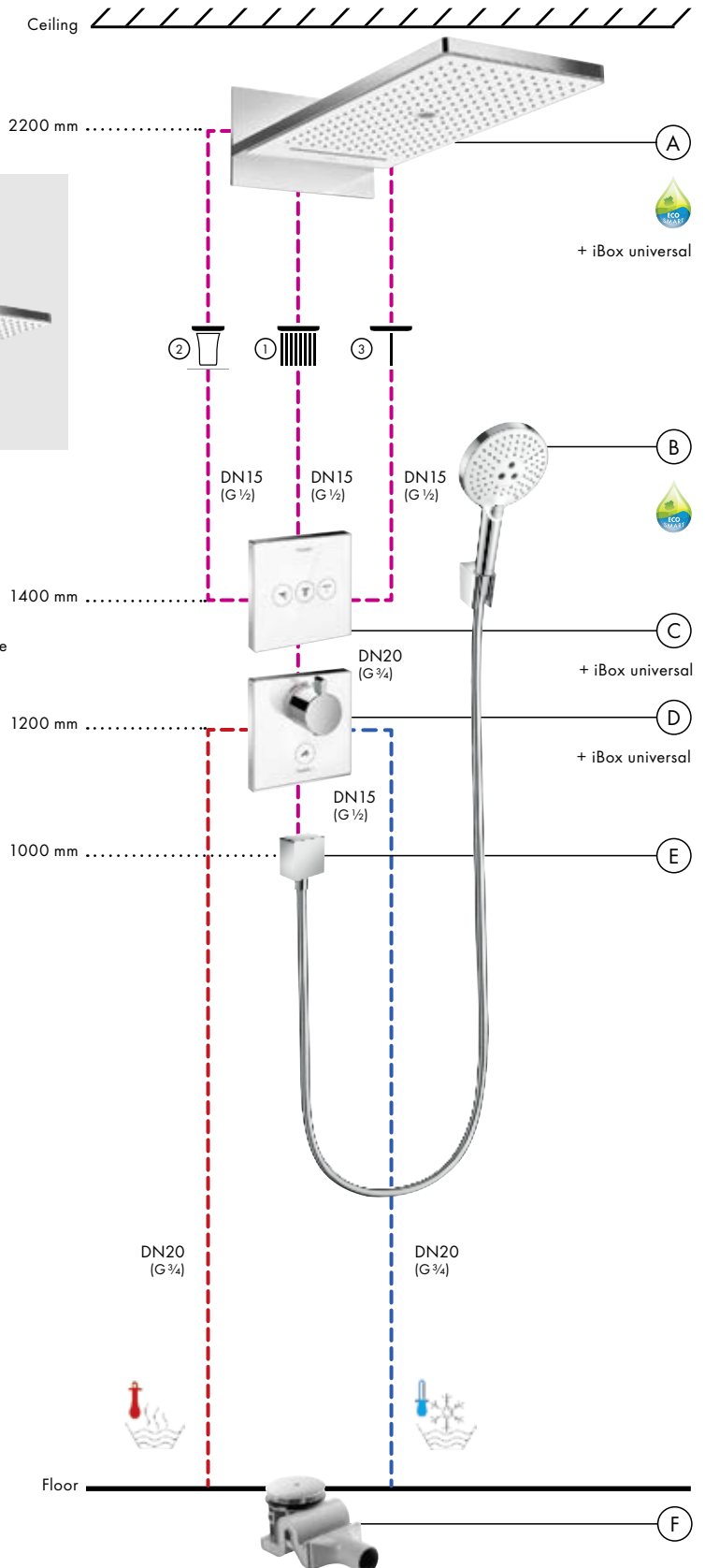

Bath installation:

ShowerTablet® Select 700 bath thermostat exposed with Raindance® Select S 120 3jet hand shower



Components

Mixers

- Ⓐ ShowerTablet Select 700 bath thermostat
13183, -400

Showers

- Ⓑ Hand shower Raindance
Select S 120 3jet
26530, -400
Porter 'S shower holder
28331, -000
Isiflex shower hose
28271, -000
- Ⓒ Waste und overflow set Flexaplus
58143, -000

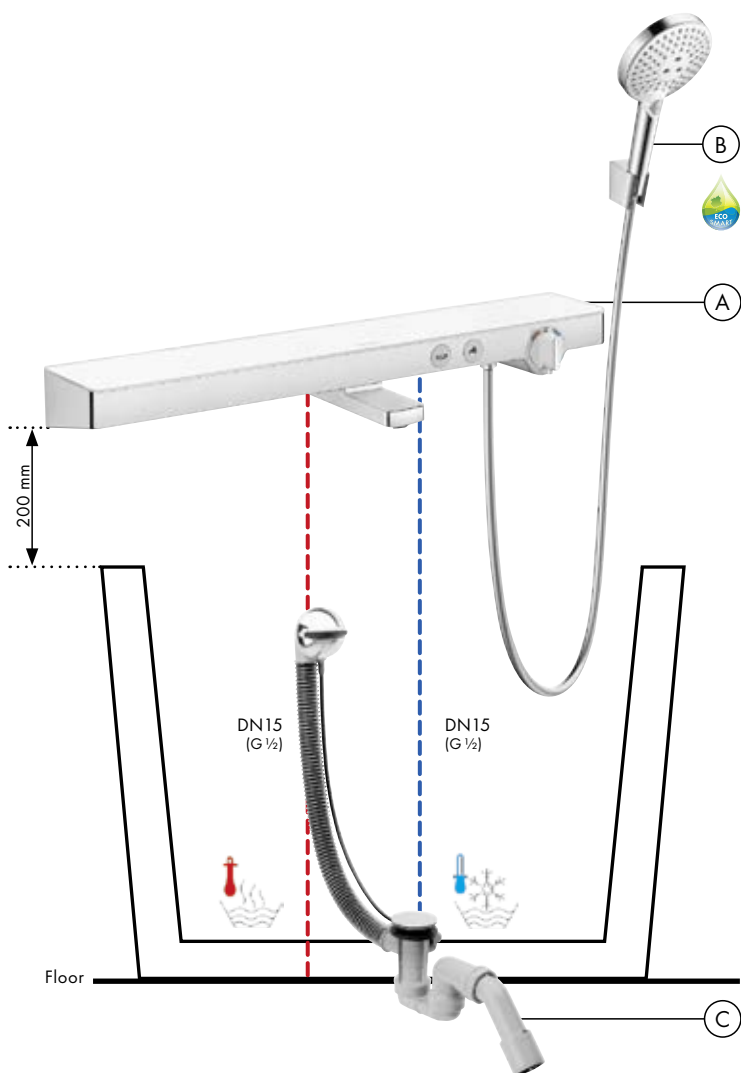

Flow diagram

Hand shower Raindance Select S 120 3jet
26530, -400

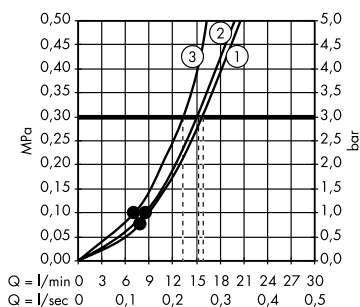

Legend

- ① RainAir
- ② Rain
- ③ Whirl

• denotes minimum operating pressure

Hansgrohe hand showers

The hand shower range at a glance

Functionality ↑

Crometta® 85

Crometta® 100

Croma® 100

Croma® Select



More details on Crometta 85 hand showers can be found on page 52 onwards.



More details on Crometta 100 hand showers can be found on page 50 onwards.



More details on Croma hand showers can be found on page 48 onwards.



More details on Croma Select hand showers can be found on page 42 onwards.

How to use the overview with your customer:

The higher a shower is positioned on the product line, the greater its functionality. All EcoSmart versions can be found on the following pages for the range.

Raindance®

Raindance® Select



Raindance® E
150 Air 3jet



Raindance® S
150 Air 3jet



Raindance® E
120 Air 3jet



Raindance® S
120 Air 3jet



Raindance® E
100 Air 3jet



Raindance® S
100 Air 3jet



Raindance® Select E
150 3jet



Raindance® Select S
150 3jet



Raindance® Select E
120 3jet



Raindance® Select S
120 3jet

More details on Raindance hand showers can be found on page 45 onwards.

More details on Raindance Select hand showers can be found on page 40 onwards.

Raindance® Select hand shower



The right water spray for each shower type

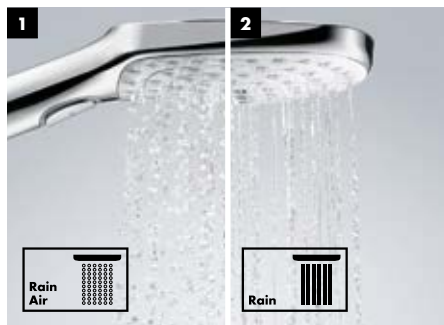

(1) **RainAir:** a gentle, caressing spray.
 (2) **Rain:** a powerful, revitalising spray.



Whirl: A concentrated massaging whirl to ease tension.



Test rating very good: 99% of users are happy with the showering feeling of the hand shower, and just as many praised the innovative Select button.*

Advantages and benefits

- Easy and convenient to change spray type at the push of a button
- Two full rain spray types in the one shower: a powerfully revitalising and a gently soothing spray
- For all showering needs: whether you want to start the day refreshed, easily rinse out shampoo, or simply relax
- For all tastes: available as a round version or with soft corners available in chrome or white/chrome

Find out more at <http://pro.hansgrohe-int.com/select>

Raindance® Select



Raindance® Select E 150 3jet
Hand shower
26550, -000, -400 (16 l/min)
26551, -000, -400 (9 l/min) EcoSmart

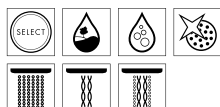

Raindance® Select E 120 3jet
Hand shower
26520, -000, -400 (16 l/min)
26521, -000, -400 (9 l/min) EcoSmart

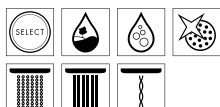

Raindance® Select S 150 3jet
Hand shower
28587, -000, -400 (16 l/min)
28588, -000, -400 (9 l/min) EcoSmart

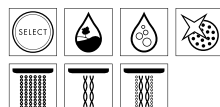

Raindance® Select S 120 3jet
Hand shower
26530, -000, -400 (16 l/min)
26531, -000, -400 (9 l/min) EcoSmart

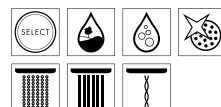

96% of users like the design and the white/chrome combination*

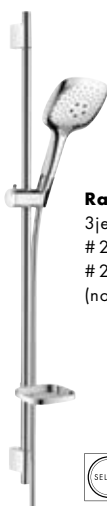

Raindance® Select E 150 3jet/Unica® 'S Puro Set
27857, -000, -400 0.90 m
27856, -000, -400 0.65 m (not shown)

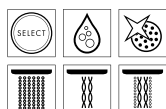

Raindance® Select E 120 3jet/Unica® 'S Puro Set
26621, -000, -400 0.90 m
26623, -000, -400 0.90 m EcoSmart
26620, -000, -400 0.65 m (not shown)
26622, -000, -400 0.65 m EcoSmart (not shown)

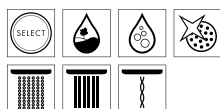

Raindance® Select S 150 3jet/Unica® 'S Puro Set
27803, -000, -400 0.90 m
27802, -000, -400 0.65 m (not shown)

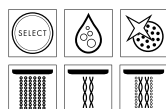

Raindance® Select S 120 3jet/Unica® 'S Puro Set
26631, -000, -400 0.90 m
26633, -000, -400 0.90 m EcoSmart
26630, -000, -400 0.65 m (not shown)
26632, -000, -400 0.65 m EcoSmart (not shown)

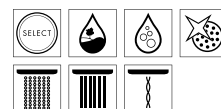

Porter Sets

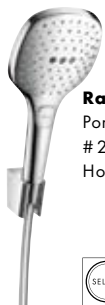

NEW

Raindance® Select E 120 Porter Set
26720, -000, -400
Hose length 1.60 m

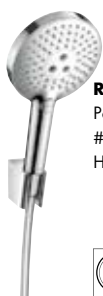
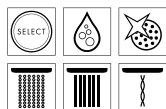

NEW

Raindance® Select S 120 Porter Set
26721, -000, -400
Hose length 1.60 m

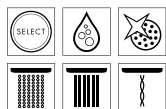

*trnd consumer test Raindance® Select E 120 10/2013 with 500 participants in D, CH, AT.

All specified flow rates are based on an operating pressure of 0.3 MPa (3 bar).

Croma® Select hand shower

NEW



More comfort for everyone

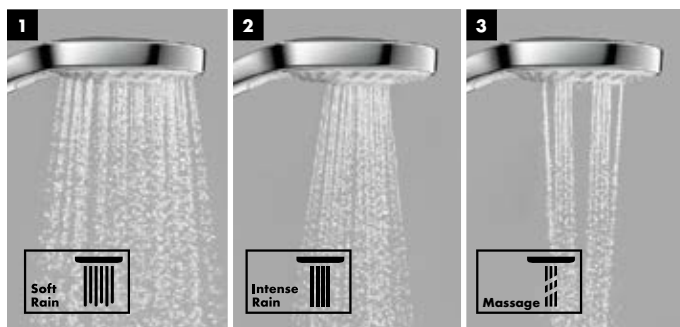
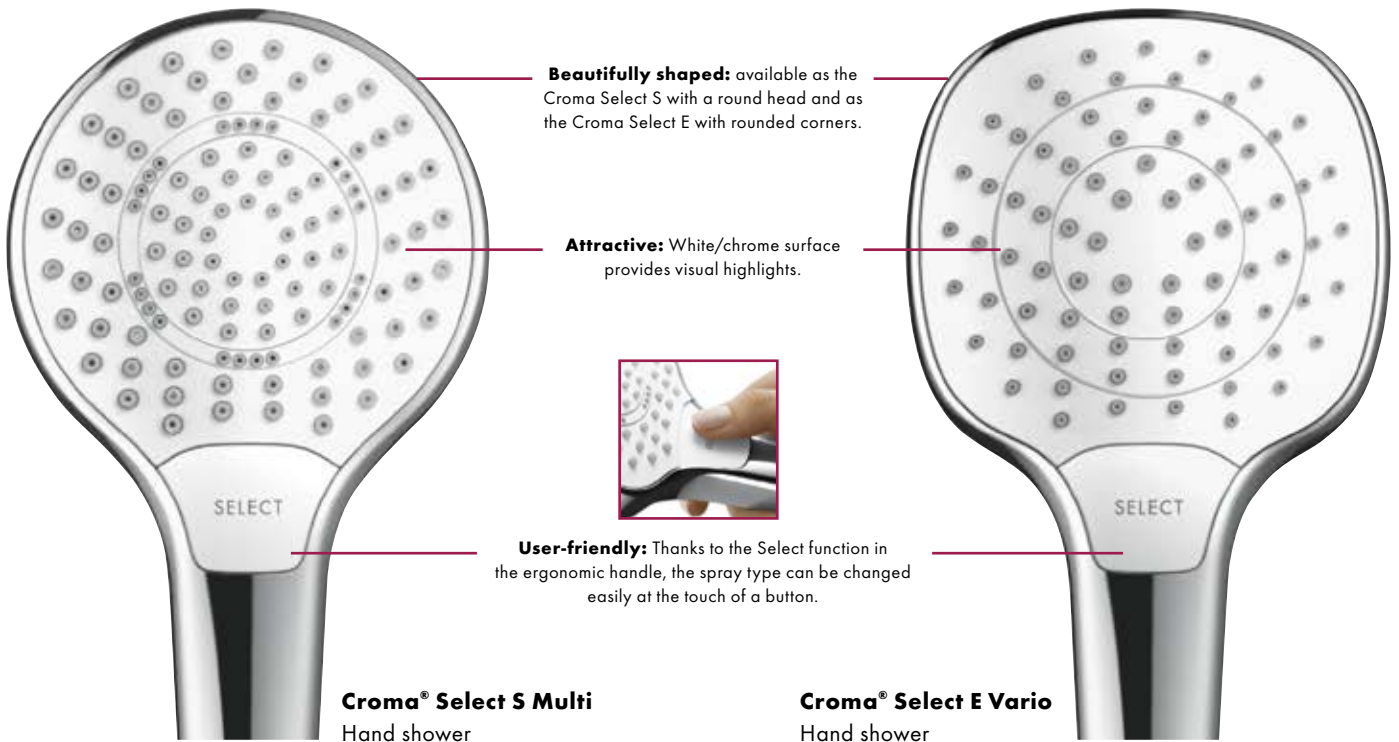

- (1) **SoftRain:** soft, beneficial water spray.
- (2) **IntenseRain:** intensive water spray that activates and refreshes.
- (3) **Massage:** concentrated, revitalising spray.

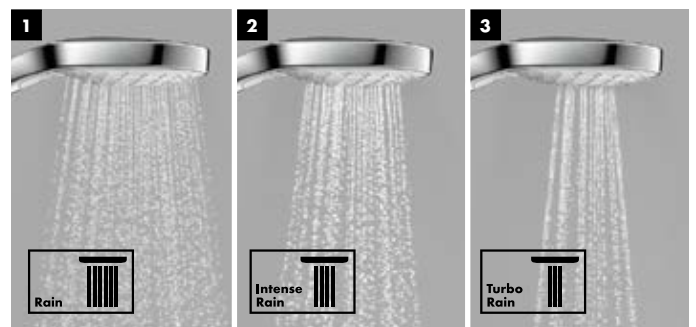

- (1) **Rain:** perfect for rinsing shampoo out of your hair.
- (2) **IntenseRain:** intensive water spray that activates and refreshes.
- (3) **TurboRain:** the most powerful of all Rain sprays - for a refreshingly powerful showering experience



Advantages and benefits

- Easy spray change at the touch of a button thanks to Select technology - now also in the Croma range
- 110 mm spray face with new spray types for any shower requirement: whether just rinsing out shampoo, winding down in the evening or being full of energy in the morning
- **Easy to clean:** thanks to QuickClean
- Also available in the water-saving EcoSmart version at just 7 l/min

Find out more at <http://pro.hansgrohe-int.com/select>

Croma® Select

NEW



Croma® Select E Multi Hand shower
 # 26810, -400 (16 l/min)
 # 26811, -400 (9 l/min) EcoSmart



Croma® Select E Vario Hand shower
 # 26812, -400 (15 l/min)
 # 26813, -400 (9 l/min) EcoSmart



Croma® Select E 1jet Hand shower
 # 26814, -400 (16 l/min)
 # 26815, -400 (9 l/min) EcoSmart
 # 26816, -400 (7 l/min) EcoSmart

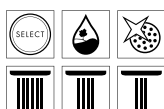
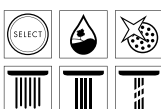

Croma® Select S Multi Hand shower
 # 26800, -400 (16 l/min)
 # 26801, -400 (9 l/min) EcoSmart



Croma® Select S Vario Hand shower
 # 26802, -400 (15 l/min)
 # 26803, -400 (9 l/min) EcoSmart



Croma® Select S 1jet Hand shower
 # 26804, -400 (16 l/min)
 # 26805, -400 (9 l/min) EcoSmart
 # 26806, -400 (7 l/min) EcoSmart

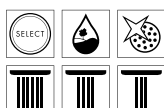
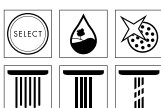

Shower sets



Croma® Select E Multi Shower Set
 # 26580, -400 0.65 m
 # 26581, -400 0.65 m EcoSmart
 # 26590, -400 0.90 m (not shown)
 # 26591, -400 0.90 m EcoSmart (not shown)

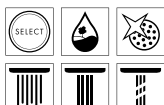

Croma® Select E Vario Shower Set
 # 26582, -400 0.65 m
 # 26583, -400 0.65 m EcoSmart
 # 26586, -400 0.65 m with Casetta soap dish (not shown)
 # 26592, -400 0.90 m (not shown)
 # 26593, -400 0.90 m EcoSmart (not shown)

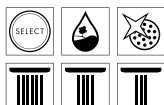

Croma® Select E 1jet Shower Set
 # 26584, -400 0.65 m
 # 26585, -400 0.65 m EcoSmart
 # 26594, -400 0.90 m (not shown)
 # 26595, -400 0.90 m EcoSmart (not shown)



Shower sets



Croma® Select S Multi Shower Set
 # 26560, -400 0.65 m
 # 26561, -400 0.65 m EcoSmart
 # 26570, -400 0.90 m (not shown)
 # 26571, -400 0.90 m EcoSmart (not shown)

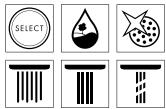

Croma® Select S Vario Shower Set
 # 26562, -400 0.65 m
 # 26563, -400 0.65 m EcoSmart
 # 26566, -400 0.65 m with Casetta soap dish (not shown)
 # 26572, -400 0.90 m (not shown)
 # 26573, -400 0.90 m EcoSmart (not shown)

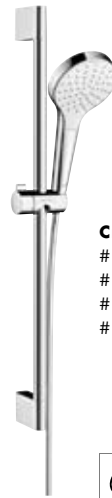
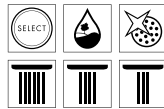

Croma® Select S 1jet Shower Set
 # 26564, -400 0.65 m
 # 26565, -400 0.65 m EcoSmart
 # 26574, -400 0.90 m (not shown)
 # 26575, -400 0.90 m EcoSmart (not shown)



Porter Sets



Croma® Select E Vario
 Porter Set
 # 26425, -400 Hose length 1.25 m
 # 26413, -400 Hose length 1.60 m

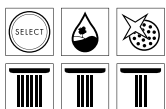

Croma® Select E 1jet
 Porter Set
 # 26424, -400 Hose length 1.25 m
 # 26412, -400 Hose length 1.60 m

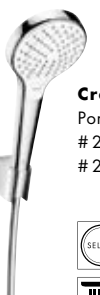
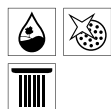

Croma® Select S Vario
 Porter Set
 # 26421, -400 Hose length 1.25 m
 # 26411, -400 Hose length 1.60 m

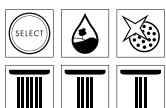

Croma® Select S 1jet
 Porter Set
 # 26420, -400 Hose length 1.25 m
 # 26410, -400 Hose length 1.60 m



All specified flow rates are based on an operating pressure of 0.3 MPa (3 bar).

Raindance®



Raindance® E 150 Air 3jet Hand shower
28518, -000 (18 l/min)
28551, -000 (9 l/min) EcoSmart



Raindance® E 120 Air 3jet Hand shower
28507, -000 (18 l/min)
28549, -000 (9 l/min) EcoSmart



Raindance® E 100 Air 3jet Hand shower
28502, -000 (15 l/min)
28553, -000 (9 l/min) EcoSmart
Raindance® E 100 Air 1jet Hand shower
28508, -000 (18 l/min) (not shown)

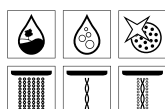
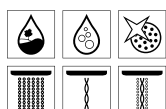

- Ergonomic short handle
- Elegant design

- Diameters up to 150 mm
- AirPower

- Three spray modes: RainAir, WhirlAir and BalanceAir



Raindance® S 150 Air 3jet Hand shower
28519, -000 (18 l/min)
28550, -000 (9 l/min) EcoSmart
Raindance® S 150 Air 1jet Hand shower
28505, -000 (17 l/min) (not shown)



Raindance® S 120 Air 3jet Hand shower
28514, -000 (18 l/min)
28554, -000 (9 l/min) EcoSmart



Raindance® S 100 Air 3jet Hand shower
28504, -000 (15 l/min)
28552, -000 (9 l/min) EcoSmart
Raindance® S 100 Air 1jet Hand shower
28509, -000 (18 l/min) (not shown)

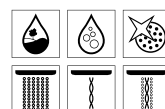
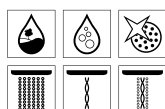
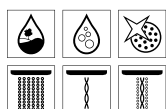

- Stylish, simple design language
- Ideal for minimalistic bathrooms

- Diameters up to 150 mm
- AirPower

- Three spray modes: RainAir, WhirlAir and BalanceAir

Porter Set



Raindance® S 100 Air 1jet/Porter 'S Set
27580, -000 Hose length 1.25 m
27581, -000 Hose length 1.60 m

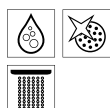

Shower sets



**Raindance® E 150 Air 3jet/
Unica® Set**
27874, -000 0.90 m
27657, -000 0.90 m EcoSmart
27888, -000 1.50 m
(not shown)

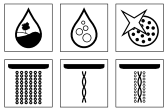

**Raindance® E 150 Air 3jet/
Unica® 'D' Set**
27894, -000 0.90 m
27897, -000 0.65 m
(not shown)

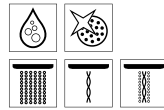

**Raindance® E 100 Air 3jet/
Unica® 'D' Set**
27881, -000 0.90 m
27883, -000 0.65 m
(not shown)
**Raindance® E 120 Air 3jet/
Unica® 'D' Set**
27885, -000 0.90 m
(not shown)
27887, -000 0.65 m
(not shown)

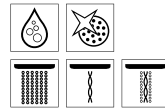

**Raindance® S 150 Air 3jet/
Unica® Set**
27893, -000 0.90 m
27658, -000 0.90 m EcoSmart

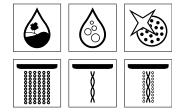

**Raindance® S 150 Air 3jet/
Unica® 'S Puro' Set**
27895, -000 0.90 m
27898, -000 0.65 m
(not shown)

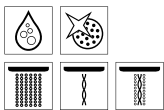

**Raindance® S 120 Air 3jet/
Unica® 'S Puro' Set**
27884, -000 0.90 m
27886, -000 0.65 m
(not shown)
**Raindance® S 100 Air 3jet/
Unica® 'S Puro' Set**
27880, -000 0.90 m
(not shown)
27882, -000 0.65 m
(not shown)

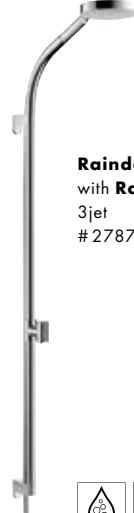
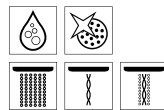

**Raindance® Rainbow® Set
with Raindance® S 150 Air
3jet**
27876, -000 0.90 m

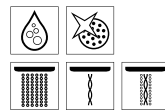

**Raindance® Allrounder Set
with Raindance® E 150 Air 3jet**
28110, -000
28108, -000 Adapter for
concealed installations
(not shown)

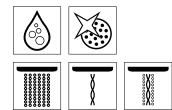

- Additional slider for height adjustments
- Use as both hand and overhead shower
- Flexible installations possible
- Large projection
- Long lasting metal construction

- Use as both hand and overhead shower
- Flexible installations possible
- Large projection
- Long lasting metal construction

Raindance® Classic



Raindance® Classic 100
Air 3jet Hand shower
28548, -000 (17 l/min)

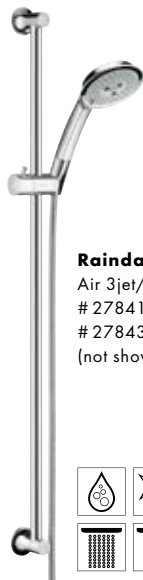
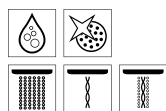

Raindance® Classic 100
Air 3jet/**Unica® Classic Set**
27841, -000 0.90 m
27843, -000 0.65 m
(not shown)

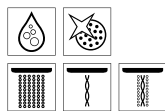

PuraVida®



DESIGN PLUS
powered by ISH
PuraVida® 150 3jet
Hand shower
28557, -000, -400 (16 l/min)
28567, -000, -400 (9 l/min)
EcoSmart

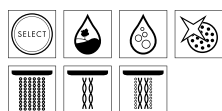

PuraVida® 120 1jet
Baton hand shower
28558, -000, -400 (16 l/min)
28568, -000, -400 (9 l/min)
EcoSmart

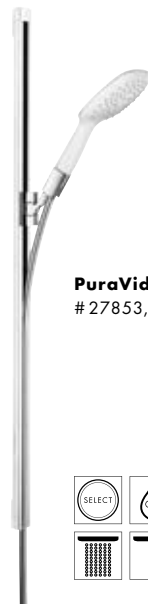
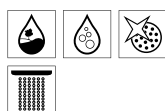

PuraVida®/Unica® Set
27853, -000, -400 0.90 m

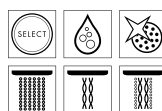

Children's hand shower



Joco®
Hand shower
28560, -000 (9 l/min)

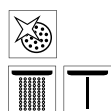

Croma® 100



Croma® 100 Multi
Hand shower
28536, -000 (19 l/min)
28538, -000 (9 l/min) EcoSmart
26830, -000 (6 l/min) EcoSmart



Croma® 100 Vario
Hand shower
28535, -000 (18 l/min)
28537, -000 (9 l/min) EcoSmart



Croma® 100 1jet
Hand shower
28580, -000 (16 l/min)
28583, -000 (9 l/min) EcoSmart

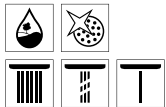

- Large spray face for great shower pleasure
- Three spray modes: Rain, Mono, Massage spray

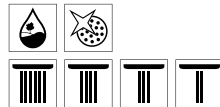

- Large spray face for great shower pleasure
- Four graduated rain sprays from wide to concentrated

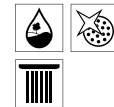

- Large spray face for great shower pleasure

Porter Sets



Croma® 100 Multi/Porter 'S Set
27593, -000 Hose length 1.25 m
27595, -000 Hose length 1.60 m



Croma® 100 Vario/Porter 'S Set
27592, -000 Hose length 1.25 m
27594, -000 Hose length 1.60 m

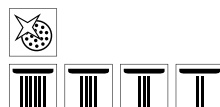

Croma® 100 1jet/Porter 'S Set
27574, -000 Hose length 1.25 m
27575, -000 Hose length 1.60 m



Shower sets



**Croma® 100 Multi/
Unica® 'C Set**
27774, -000 0.90 m
27655, -000 0.90 m
EcoSmart
27775, -000 0.65 m
(not shown)
27777, -000 0.65 m
EcoSmart (not shown)

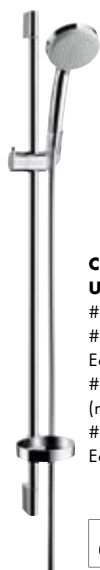

**Croma® 100 Vario/
Unica® 'C Set**
27771, -000 0.90 m
27653, -000 0.90 m
EcoSmart
27772, -000 0.65 m
(not shown)
27776, -000 0.65 m
EcoSmart (not shown)

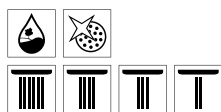

**Croma® 100 1jet/
Unica® 'C Set**
27724, -000 0.90 m
27717, -000 0.65 m
(not shown)



**Croma® 100 Multi/
Unica® 'Reno Lift Set**
27791, -000 1.05 m
**Croma® 100 Vario/
Unica® 'Reno Lift Set**
27811, -000 1.05 m
(not shown)

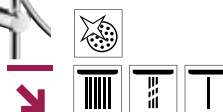

- Swivelling shower bar
- Drilled hole can be covered, so ideal for renovations

Croma® 100 Classic



Croma® 100 Classic Multi
Hand shower
28539, -000 (19 l/min)



Crometta® 100 hand shower

NEW

Genuine design at an irresistible price

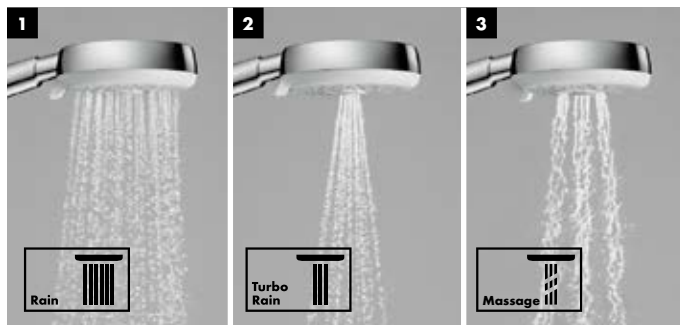
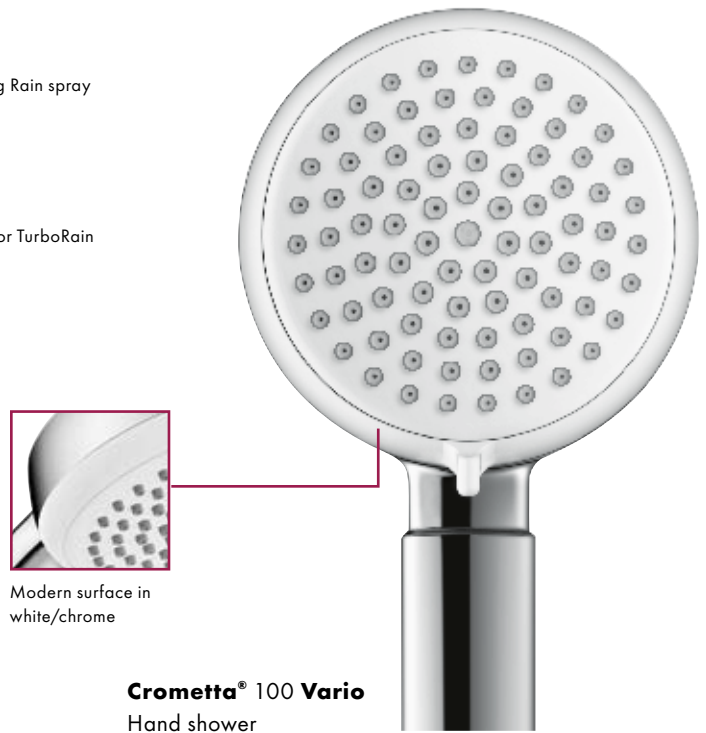
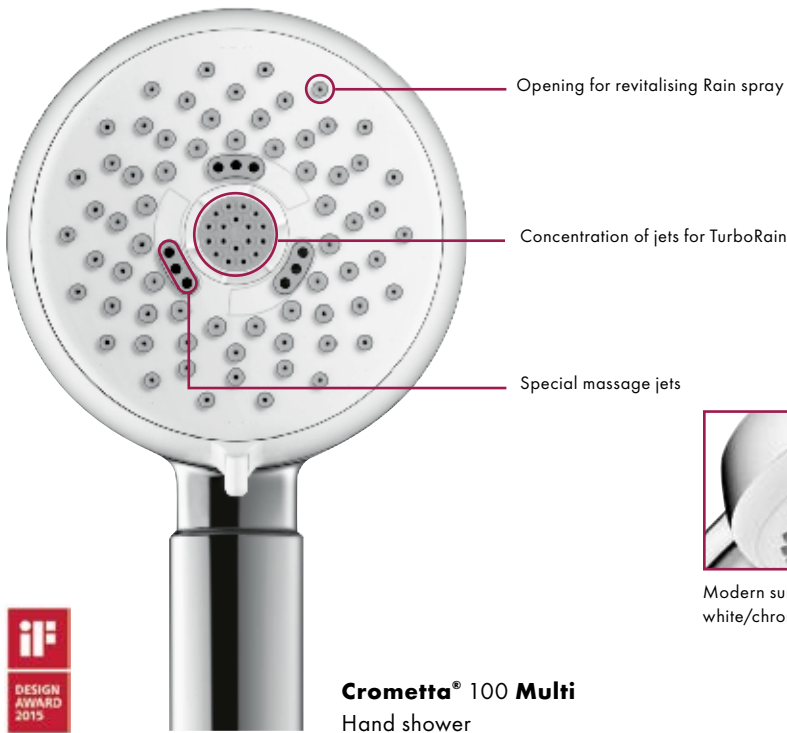

- (1) **Rain:** revitalising shower rain.
- (2) **TurboRain:** the most powerful of all Rain sprays – for a refreshingly powerful showering experience.
- (3) **Massage:** powerful, pulsating spray.

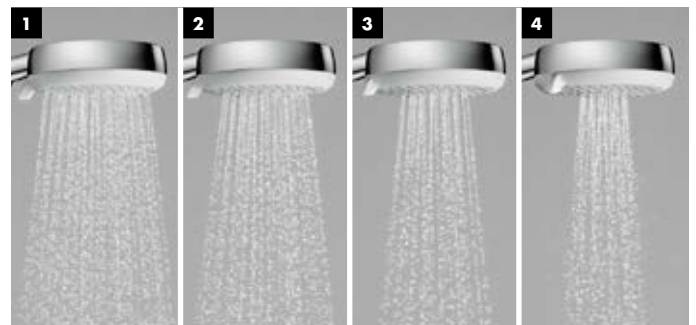

- (1-4) **Rain variants:** revitalising spray rain in 4 levels from wide to concentrated.



Advantages and benefits

- XXL showering pleasure thanks to the 100 mm spray face
- Excellent value thanks to the popular Croma 100 mechanism and popular spray technology at the best price
- Many different spray types for any showering type – from wide to concentrated
- Ergonomic handle design for safe use
- **Easy to clean:** thanks to QuickClean
- Also available in the water-saving EcoSmart version at just 7 l/min

Crometta® 100



Crometta® 100 Multi
Hand shower
26823, -400 (19 l/min)
26826, -400 (9 l/min) EcoSmart



Crometta® 100 Vario
Hand shower
26824, -400 (18 l/min)
26827, -400 (9 l/min) EcoSmart



Crometta® 100 1jet
Hand shower
26825, -400 (16 l/min)
26828, -400 (9 l/min) EcoSmart
26829, -400 (7 l/min) EcoSmart



Porter Sets



Crometta® 100 Vario
Porter Set
26666, -400 Hose length 1.25 m
26667, -400 Hose length 1.60 m



Crometta® 100 1jet
Porter Set
26664, -400 Hose length 1.25 m
26665, -400 Hose length 1.60 m

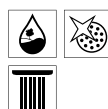

Shower sets



Crometta® 100 Multi
Shower Set
26656, -400 0.90 m
26659, -400 0.90 m EcoSmart
26650, -400 0.65 m (not shown)
26653, -400 0.65 m EcoSmart
(not shown)



Crometta® 100 Vario
Shower Set
26657, -400 0.90 m
26662, -400 0.90 m EcoSmart
26651, -400 0.65 m (not shown)
26654, -400 0.65 m EcoSmart
(not shown)

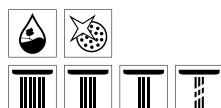

Crometta® 100 1jet
Shower Set
26658, -400 0.90 m
26663, -400 0.90 m EcoSmart
26652, -400 0.65 m (not shown)
26655, -400 0.65 m EcoSmart
(not shown)



All specified flow rates are based on an operating pressure of 0.3 MPa (3 bar).

Crometta® 85



Crometta® 85 Multi
Hand shower
28563, -000 (16 l/min)
28608, -000 (9 l/min)
EcoSmart

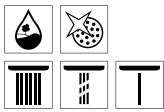

Crometta® 85 Vario
Hand shower
28562, -000 (17 l/min)
28607, -000 (9 l/min)
EcoSmart
26831, -000 (6 l/min)
EcoSmart

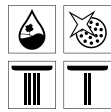

Crometta® 85 1jet
Hand shower
28585, -000 (16 l/min)
28606, -000 (9 l/min)
EcoSmart

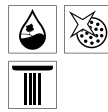

Crometta® 85 Green
Hand shower
28561, -000 (6 l/min)



- Great value, suitable for many combinations
- Many spray types
- Also ideal as a shower for the bathtub

Porter Sets



**Crometta® 85 Multi/
Porter 'C Set**
27568, -000
Hose length 1.25 m
27569, -000
Hose length 1.60 m

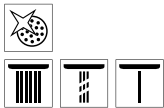

**Crometta® 85 Vario/
Porter 'C Set**
27558, -000
Hose length 1.25 m
27559, -000
Hose length 1.60 m

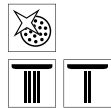

**Crometta® 85 1jet/
Porter 'C Set**
27576, -000
Hose length 1.25 m
27577, -000
Hose length 1.60 m



Shower sets

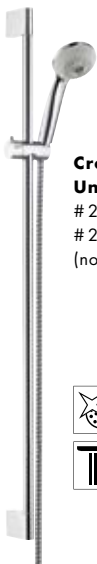

**Crometta® 85 Multi/
Unica® 'Crometta® Set**
27766, -000 0.90 m
27767, -000 0.65 m
(not shown)

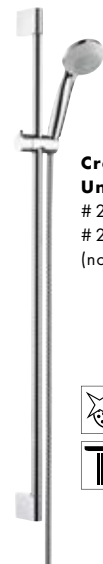
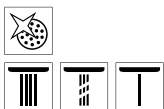



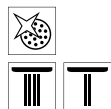



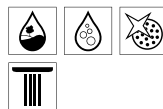



**Crometta® 85 Vario/
Unica® 'Crometta® Set**
27762, -000 0.90 m
27763, -000 0.65 m
(not shown)



**Crometta® 85 1jet/
Unica® 'Crometta® Set**
27729, -000 0.90 m
27728, -000 0.65 m (not shown)
**Crometta® 85 Green/
Unica® 'Crometta® Set**
27651, -000 0.90 m (not shown)
27652, -000 0.65 m (not shown)







Shower bars

 <p>PuraVida® Unica® Shower bar with Isiflex shower hose 1.60 m # 27844, -000 0.90 m</p>	 <p>Raindance® Unica® Shower bar with Isiflex shower hose 1.60 m # 27636, -000 0.90 m</p>	 <p>Unica® 'S Puro Shower bar with Isiflex shower hose 1.60 m # 28632, -000 0.65 m # 28631, -000 0.90 m (not shown)</p>	 <p>Unica® 'Classic Shower bar with Sensoflex shower hose 1.60 m # 27617, -000 0.65 m</p>	 <p>Unica® 'D Shower bar with Isiflex shower hose 1.60 m # 27933, -000 0.65 m # 27930, -000 0.90 m (not shown)</p>
 <p>Unica® 'C Shower bar with Isiflex shower hose 1.60 m # 27611, -000 0.65 m # 27610, -000 0.90 m (not shown)</p>	 <p>Unica® 'Croma® Shower bar with Isiflex shower hose 1.60 m # 26503, -000 0.65 m # 26504, -000 0.90 m (not shown) Alternatively without flexible hose # 26506, -000 0.90 m (not shown) # 26505, -000 0.65 m (not shown)</p>	 <p>Unica® 'Crometta® Shower bar with Metaflex shower hose 1.60 m # 27615, -000 0.65 m # 27614, -000 0.90 m (not shown) Alternatively without flexible hose # 27609, -000 0.90 m (not shown)</p>	 <p>Unica® 'S Puro Reno Shower bar # 28662, -000 0.72 m # 28663, -000 1.05 m (not shown)</p>	 <p>Unica® 'Reno Shower bar # 27704, -000 0.72 m</p>



- Adjustable shower heights and angles
- Hands-free showering
- Flexible installations in shower cubicles and baths
- Shower can be swivelled out

Shower hoses

 <p>Sensoflex® Shower hose metal with plastic lining and swivel # 28132, -000 1.25 m # 28136, -000 1.60 m # 28134, -000 2.00 m</p>	 <p>Isiflex® Shower hose of metal-look plastic # 28272, -000, -450 1.25 m # 28276, -000, -450 1.60 m # 28274, -000 2.00 m</p>	 <p>Isiflex® EcoSmart metal-look shower hose with integrated flow rate limiter (9 l/min) # 28270, -000 1.25 m # 28271, -000 1.60 m # 28188, -000 2.00 m</p>	 <p>Metaflex® Shower hose of metal-spiral-look plastic # 28262, -000 1.25 m # 28266, -000 1.60 m # 28264, -000 2.00 m</p>	 <p>Metaflex® EcoSmart shower hose of metal-spiral-look plastic with integrated flow rate limiter (9 l/min) # 28198, -002 1.25 m # 28195, -002 1.50 m # 28199, -002 1.60 m # 28196, -002 1.75 m # 28197, -002 2.00 m</p>
---	---	---	--	--



- Various materials, lengths and looks
- Anti-kink and easy care
- Chrome effect matching the mixers
- Scratch free thanks to plastic coating
- Swivel for twist-free flexibility
- Particularly strong – confirmed by tension tests

Shower holder



Porter 'S
Shower holder
28331, -000



Porter 'C
Shower holder
27521, -000



Porter 'D
Variable shower holder
Adjustable angle
27526, -000



Porter 'Classic
Shower holder
28324, -000



Porter 'A
Variable shower holder
Metal housing
Adjustable angle
27520, -000

Hose connections



Fixfit* E
Hose connection without non-return valve
27454, -000
Hose connection with non-return valve
27458, -000
Hose connection with non-return valve and pivot joint
27505, -000 (not shown)



Fixfit* E
Hose connection with non-return valve and plastic angle
26457, -000
Hose connection with non-return valve and pivot joint
27414, -000 (not shown)



Fixfit* E Stop
Hose connection with shut-off valve and non-return valve
27452, -000



Fixfit* S
Hose connection with non-return valve and plastic angle
26453, -000
Hose connection without non-return valve
27453, -000
Hose connection with non-return valve
27456, -000
Hose connection with non-return valve and pivot joint
27506, -000 (not shown)



Fixfit* Square
Hose connection with non-return valve and plastic angle
26455, -000



Fixfit* Classic
Hose connection with non-return valve
16884, -000, -820

Shower support with hose connection

NEW



Fixfit® Porter 'S

Hose connection DN15 with integrated shower support
Flexible hose and hand shower can be chosen freely
26487, -000



Fixfit® Porter 'E

Hose connection DN15 with integrated shower support
Flexible hose and hand shower can be chosen freely
26485, -000



Fixfit® Porter 'Square

Hose connection DN15 with integrated shower support
Flexible hose and hand shower can be chosen freely
26486, -000



Porter 'E

Variable shower holder
Hose length 1.25 m
Adjustable angle
27507, -000



- Three different designs to suit any finish set and shower

- Permanently safe function thanks to the high-quality metal housing and internal plastic water channels

- Few drill holes, so installation is fast and easy
- Suits any DN15 flexible hose



- Integrated hose connection
- Isiflex shower hose 1.25 m

Soap dishes



Casetta® 'E

Soap dish
26519, -000



Casetta® 'C

Soap dish
28678, -000



Casetta® 'S Puro

Soap dish
28679, -000

Hansgrohe overhead showers

The overhead shower range at a glance

Functionality ↑

Crometta®

Croma®/Croma® Select

Raindance®



Crometta® 160

More details on Crometta overhead showers can be found on pages 66 onwards.



Croma® 220 1jet



Croma® Select E 180 2jet



Croma® Select S 180 2jet

More details on Croma and Croma Select overhead showers can be found on pages 62 onwards.



Raindance® E 420 Air 2jet
Raindance® E 420 Air 1jet
(not shown)



Raindance® E 360 Air 1jet
Raindance® E 240 Air 1jet
(not shown)



Raindance® Royale S 350 Air 1jet



Raindance® S 300 Air 1jet



Raindance® 260 Air 1jet



Raindance® S 240 Air 1jet

More details on Raindance E and Raindance S overhead showers can be found on pages 64 onwards.

How to use the overview in your sales presentation.

The higher an overhead shower is positioned on the product line, the greater its functionality. The products are arranged in ranges extending to the right.

Raindance® Select

**Raindance® Rainmaker®/
Raindance® Rainfall®**

Rainmaker® Select



Raindance® Select E
300 3jet



Raindance® Select S
300 2jet



Raindance® Select S
300 2jet
Raindance® Select S
240 2jet (not shown)

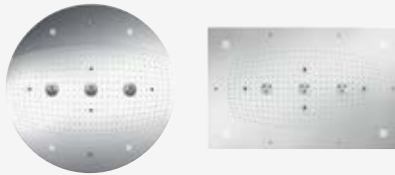

Raindance® Rainmaker®
Air 3jet



Raindance® Rainfall®
240 Air 3jet



Raindance® Rainfall®
180 Air 2jet



Raindance® Rainfall®
150 1jet



Raindance® Rainfall® Stream
150 1jet

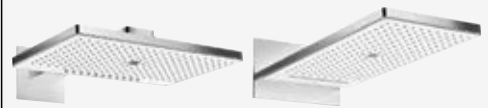

Rainmaker® Select
460 3jet

Rainmaker® Select
580 3jet



Rainmaker® Select 460 2jet
Rainmaker® Select 460 1jet
(not shown)

More details on Raindance Select overhead showers can be found on pages 60 onwards.

More details on Raindance Rainmaker and Raindance Rainfall overhead showers can be found on pages 68 onwards.

More details on Rainmaker Select overhead showers can be found on pages 58 onwards.

Rainmaker® Select 460 3jet overhead shower

NEW

Tremendous pleasure across the whole width

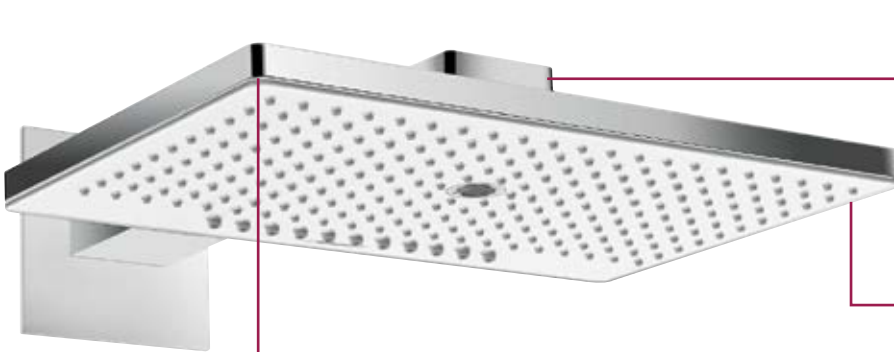

QuickConnect holder for easy attachment and quick removal for cleaning



A bathroom highlight thanks to high-quality materials such as chrome-plated metal and safety glass with lasered holes



Surface white/
chrome

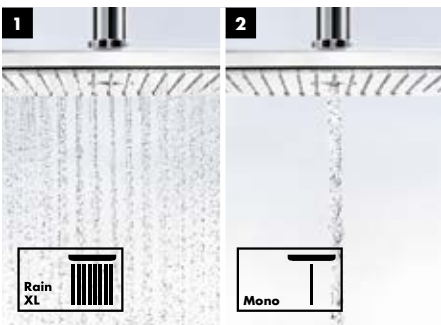

(1) **Rain XL:** full rain spray for tremendous showering pleasure.

(2) **Mono:** bundled spray for targeted showering pleasure.



RainStream: Eleven jets run parallel down to the floor for a generous shower.



Flexible: Also available for ceiling mounting, when it can be positioned freely anywhere in the room.



Advantages and benefits

- Clear, precise design for the modern bathroom
- Spatial character meets the trend for larger showers
- **Easy to clean:** the glass panel is resistant to detergents, which makes it suitable for hotels as well
- The height of the wall mounted product can be varied for an optimum spray intensity.
- Also available in the EcoSmart version with only 9 l/min

Rainmaker® Select

NEW



Rainmaker® Select 580 3jet
 Overhead shower
 Rain XL: 17 l/min
 RainFlow: 17 l/min
 Mono: 19 l/min
 # 24001, -400
 # 24011, -400 (9 l/min) EcoSmart
 for iBox universal



Surface white/chrome



Black glass surface available on request

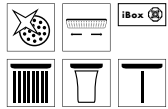

Rainmaker® Select 460 3jet
 Overhead shower, with shower arm 460 mm
 Rain XL: 18 l/min
 RainStream: 16 l/min
 Mono: 19 l/min
 # 24007, -400
 # 24017, -400 (9 l/min) EcoSmart
 for iBox universal

Rainmaker® Select 460 3jet
 Overhead shower, with ceiling connection 100 mm (not shown)
 Rain XL: 20 l/min
 RainStream: 17 l/min
 Mono: 21 l/min
 # 24006, -400
 # 24016, -400 (9 l/min) EcoSmart



Rainmaker® Select 460 2jet
 Overhead shower, with shower arm 460 mm
 Rain XL: 18 l/min
 RainStream: 16 l/min
 # 24005, -400
 # 24015, -400 (9 l/min) EcoSmart
 for iBox universal

Rainmaker® Select 460 2jet
 Overhead shower, with ceiling connection 100 mm (not shown)
 Rain XL: 20 l/min
 RainStream: 17 l/min
 # 24004, -400
 # 24014, -400 (9 l/min) EcoSmart



Rainmaker® Select 460 1jet
 Overhead shower, with shower arm 460 mm
 Rain XL: 18 l/min
 # 24003, -400
 # 24013, -400 (9 l/min) EcoSmart

Rainmaker® Select 460 1jet
 Overhead shower, with ceiling connection 100 mm (not shown)
 Rain XL: 19 l/min
 # 24002, -400
 # 24012, -400 (9 l/min) EcoSmart

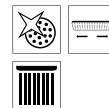
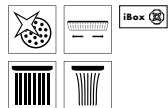
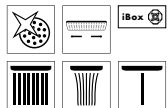

Raindance® Select E 300 3jet overhead shower



1 button, three sprays, great fun

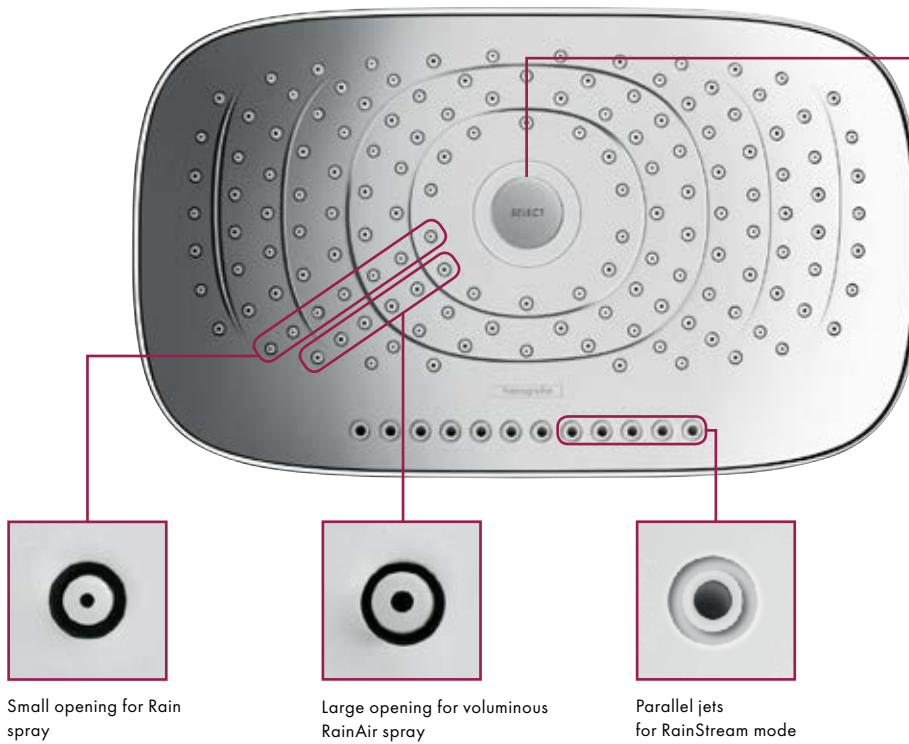

Easily accessible, the Select button need only be touched to change between RainAir and Rain



Small opening for Rain spray



Large opening for voluminous RainAir spray



Parallel jets for RainStream mode

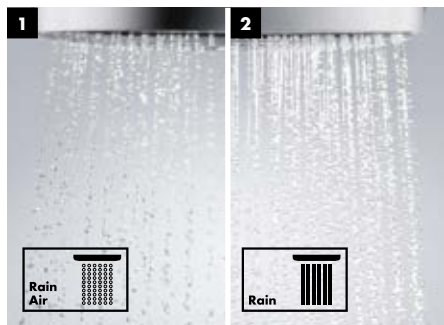

(1) **RainAir:** This gentle, relaxing spray consists of large, soft drops.
 (2) **Rain:** A spray that is strong and revitalising and perfect for washing the hair.



RainStream: Twelve jets run parallel down to the floor for a generous shower.

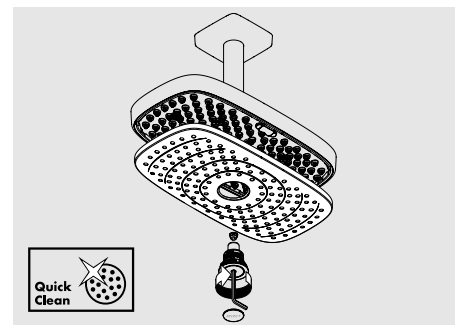

Easy cleaning: Jets can be cleaned effortlessly with the QuickClean function. Spray face can be taken off easily and is even dishwasher safe.



Advantages and benefits

- 3 full spray types in the one overhead shower: gentle RainAir, powerful Rain and effective RainStream
- Simply switch between RainAir and Rain at the touch of a button
- Select button is easily accessible
- **Easy cleaning:** the metal spray face is dishwasher safe

Find out more at <http://pro.hansgrohe-int.com/select>

Raindance® Select



Raindance® Select E 300 3jet
Overhead shower
26468, -000, -400
Rain/RainAir: 18 l/min
RainStream: 22 l/min
with shower arm 390 mm
for iBox universal

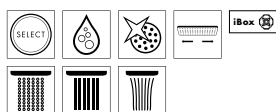

Raindance® Select E 300 2jet
Overhead shower
Rain/RainAir: 15 l/min
with shower arm 390 mm
27385, -000, -400
26609, -000, -400 (Rain/RainAir: 9 l/min) EcoSmart
with ceiling connection 100 mm (not shown)
27384, -000, -400
26608, -000, -400 (Rain/RainAir: 9 l/min) EcoSmart (not shown)



Raindance® Select S 300 2jet
Overhead shower
Rain/RainAir: 17 l/min
27378, -000, -400 with shower arm 390 mm
27337, -000, -400 with ceiling connection 100 mm (not shown)

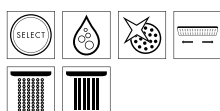

Raindance® Select S 240 2jet
Overhead shower
Rain/RainAir: 17 l/min
with shower arm 390 mm
26466, -000, -400
26470, -000, -400 (Rain/RainAir: 9 l/min) EcoSmart
with ceiling connection 100 mm (not shown)
26467, -000, -400
26469, -000, -400 (Rain/RainAir: 9 l/min) EcoSmart (not shown)

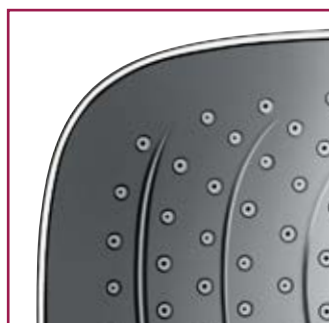
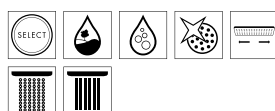

Surface chrome

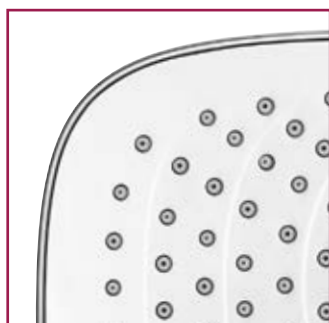

Surface white/chrome

Croma® Select overhead shower

NEW

Comfort in top form

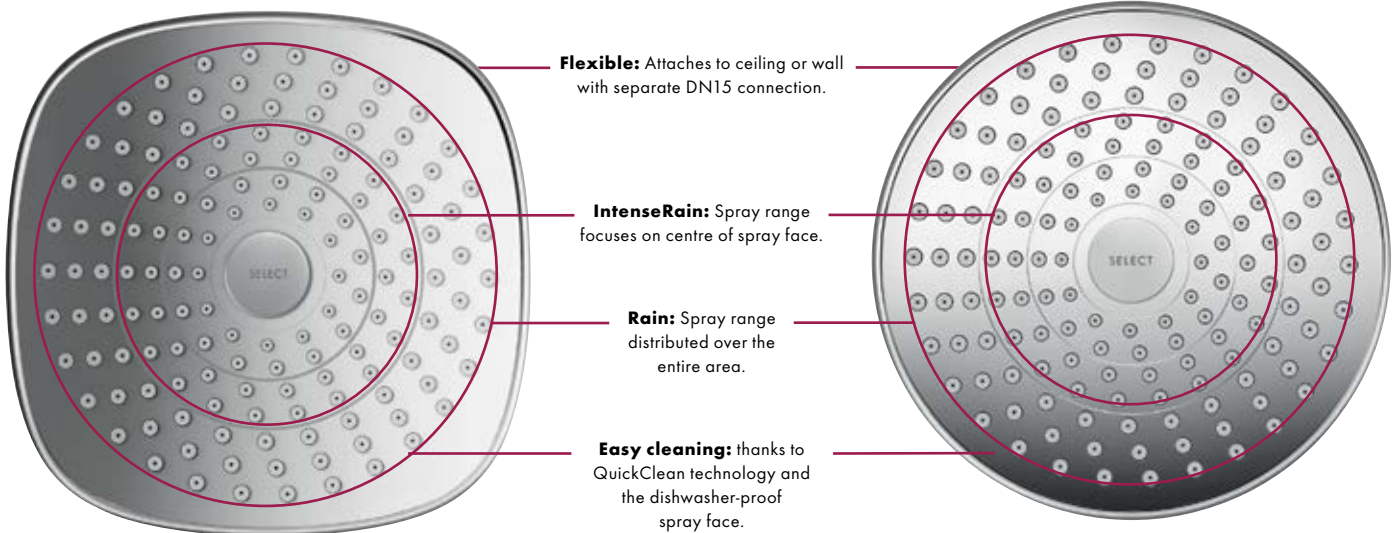
**Croma® Select E** 180 2jet**Croma® Select S** 180 2jet

Rain: flat rain from large, feel-good water drops.



IntenseRain: intensive water spray that activates and refreshes.



User-friendly: A simple touch of the Select button (from below) is all it takes to change the spray type.



Advantages and benefits

- New design language with a large spray face of 180 mm diameter
- Available in two finishes: chrome and white/chrome
- Two different rain sprays: flat Rain spray, and refreshing, intensive IntenseRain
- Easy to change the spray types at the touch of a button
- Also available in the EcoSmart version with only 9 l/min

Find out more at <http://pro.hansgrohe-int.com/select>

Croma® Select



Croma® Select E 180 2jet
Overhead shower
Rain/IntenseRain: 17 l/min
26524, -000, -400
26528, -000, -400 (9 l/min) EcoSmart



Croma® Select E
Shower arm 390 mm
27446, -000



Croma® Select E
Ceiling connection
27467, -000 100 mm
27388, -000 300 mm (not shown)

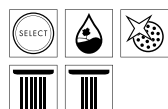

Croma® Select S 180 2jet
Overhead shower
Rain/IntenseRain: 17 l/min
26522, -000, -400
26523, -000, -400 (9 l/min) EcoSmart



Croma® Select S
Shower arm 390 mm
27413, -000



Croma® Select S
Ceiling connection
27393, -000 100 mm
27389, -000 300 mm (not shown)

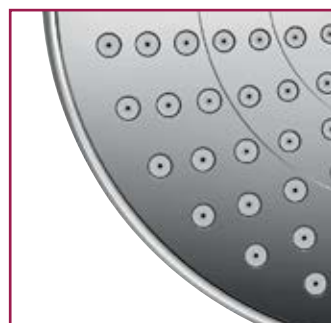
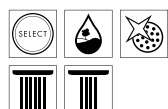

Surface chrome

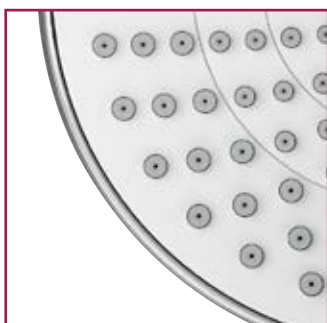

Surface white/chrome

All specified flow rates are based on an operating pressure of 0.3 MPa (3 bar).

Raindance®



Raindance® E 420 Air 2jet
Overhead shower
27373, -000 with shower arm 380 mm
RainAir: 22 l/min
RainFlow: 23 l/min
for iBox universal



Raindance® E 420 Air 1jet
Overhead shower (19 l/min)
27372, -000 with shower arm 380 mm

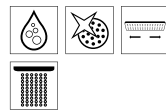

Raindance® E 360 Air 1jet
Overhead shower (17 l/min)
27376, -000 with shower arm 390 mm
27371, -000 with shower arm 240 mm (not shown)
27381, -000 with ceiling connection 100 mm (not shown)

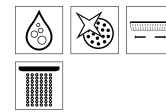

Raindance® E 240 Air 1jet
Overhead shower (20 l/min)
27370, -000 with shower arm 240 mm
27380, -000 with ceiling connection 100 mm (not shown)
27375, -000 with shower arm 223 mm (9 l/min) EcoSmart (not shown)
27383, -000 with ceiling connection 100 mm (9 l/min) EcoSmart (not shown)





Raindance® Royale S 350 Air 1jet

Overhead shower (25 l/min)

28420, -000

27410, -000 Shower arm 470 mm (not shown)

27418, -000 Ceiling connection 100 mm (not shown)



Raindance® S 300 Air 1jet

Overhead shower (18 l/min)

27493, -000 with shower arm 390 mm

27492, -000 with shower arm 450 mm (not shown)

27494, -000 with ceiling connection 100 mm (not shown)

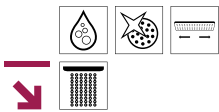

- Particularly large spray face of 350 mm diameter
- High flow rate for luxurious shower pleasure
- All-metal

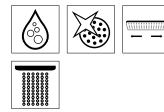

Raindance® S 240 Air 1jet

Overhead shower (18 l/min)

27474, -000 with shower arm 390 mm

27461, -000 with shower arm 390 mm (9 l/min) EcoSmart

27477, -000 with ceiling connection 100 mm (not shown)

27463, -000 with ceiling connection 100 mm (9 l/min) EcoSmart (not shown)



Raindance® S 180 Air 1jet

Overhead shower (19 l/min)

27476, -000 with shower arm 240 mm

27462, -000 with shower arm 240 mm (9 l/min) EcoSmart

27468, -000 with shower arm 390 mm (not shown)

27478, -000 with ceiling connection 100 mm (not shown)

27464, -000 with ceiling connection 100 mm (9 l/min) EcoSmart (not shown)

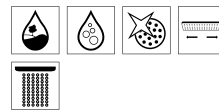

Raindance® Classic



Raindance® Classic 240 Air

Overhead shower (19 l/min)

27424, -000 with shower arm 390 mm

27405, -000 with ceiling connection 100 mm (not shown)

PuraVida®



PuraVida® 400

Overhead shower (21 l/min)

27437, -000, -400 with shower arm 390 mm

26602, -000, -400 (9 l/min) EcoSmart

27390, -000, -400 with ceiling connection 100 mm (not shown)

26603, -000, -400 (9 l/min) EcoSmart (not shown)

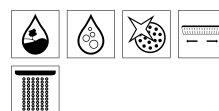
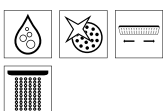

Croma®



Croma® 220 Air 1jet
Overhead shower
26464, -000 (19 l/min)
26465, -000 (9 l/min) EcoSmart
27413, -000 Optional shower arm
390 mm (not shown)
27479, -000 Optional ceiling
connection 100 mm (not shown)



Croma® 160 1jet
Overhead shower
27450, -000 (17 l/min)
28450, -000 (9 l/min) EcoSmart
27412, -000 Optional shower arm
230 mm (not shown)
27479, -000 Optional ceiling
connection 100 mm (not shown)



Croma® 100 Multi
Overhead shower
27443, -000
Rain: 20 l/min
Mono: 15 l/min
Massage: 14 l/min
with ball joint DN15
28460, -000 (9 l/min) EcoSmart
27411, -000 Optional shower arm
128 mm (not shown)



Croma® 100 Vario
Overhead shower
27441, -000
Rain: 22 l/min
Shampoo: 17 l/min
Normal: 20 l/min
Massage: 11 l/min
28462, -000 (9 l/min) EcoSmart
27411, -000 Optional shower arm
128 mm (not shown)

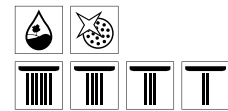
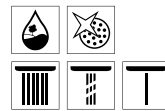
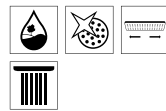
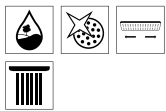

Crometta® 160

NEW



Crometta® 160
Overhead shower
26577, -000, -400 (17 l/min)
26578, -000, -400 (9 l/min) EcoSmart
27412, -000 Optional shower arm 230 mm (not shown)
27479, -000 Optional ceiling connection 100 mm
(not shown)

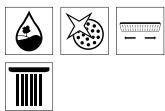

- Attractive price for large scale projects e.g. hotels
- Available in the water-saving EcoSmart version at just 9 l/min
- Also available in a LowPressure version (from 0.2 bar)
- Modern new design language with the surface in white/chrome
- Large spray face of 160 mm diameter



Surface chrome



Surface white/chrome



Crometta® 85



Crometta® 85 Multi

Overhead shower
 # 28425, -000
 Mono: 13 l/min
 Normal: 15 l/min
 Massage: 13 l/min
 # 27411, -000 Optional shower arm
 128 mm (not shown)



Crometta® 85 Vario

Overhead shower
 # 28424, -000
 Normal: 18 l/min
 # 27411, -000 Optional shower arm
 128 mm (not shown)



Crometta® 85 Green

Overhead shower
 # 28423, -000 (6 l/min)
 # 27411, -000 Optional shower arm
 128 mm (not shown)

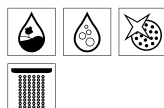
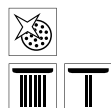
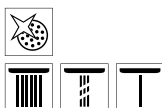

Side showers



PuraVida® 100
 Side shower
 # 28430, -000, -400



Raindance® Air 100
 Side shower
 # 28477, -000



Bodyvette®
 Side shower
 # 28466, -000
Bodyvette® Stop
 Side shower, manual shut-off
 # 28467, -000 (not shown)

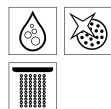
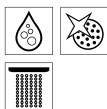

Raindance® Rainmaker® and Raindance® Rainfall®

The ultimate enjoyment for your customers

The Raindance Rainmaker and the Raindance Rainfall turn everyday showering into a new experience. The Raindance Rainmaker is installed flush in the ceiling. The classic shower therefore no longer exists,

instead there is a room filled with wonderful rain. The spray modes are RainAir, RainAir XL, Whirl and Mix. With its horizontal rain panel, Raindance Rainfall allows greater freedom of movement and offers up to three different spray

types for pampered showering: relaxing RainAir, revitalising RainFlow and massaging Whirl.

Raindance® Rainmaker®: Showering in a new dimension

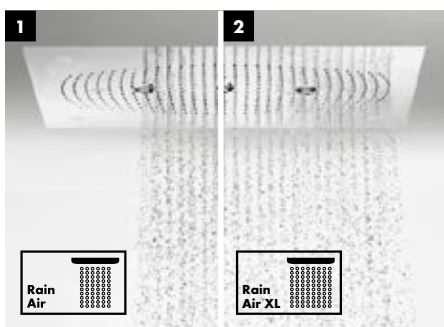

(1) **RainAir:** Central overhead shower function with AirPower technology.

(2) **RainAir XL:** Full, soft rain with AirPower technology.

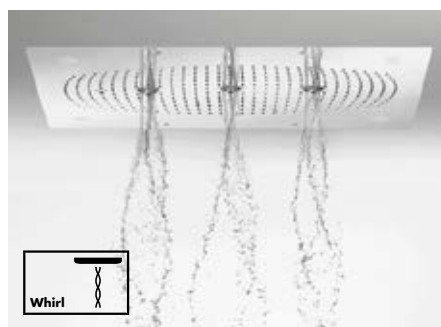

Whirl: Three rotating massage sprays with AirPower technology.



Advantages and benefits

- Installed flush in the ceiling
- Full shower rain
- Also with integrated lighting

Raindance® Rainfall® 240 Air 3jet: Water with its original power



RainAir: The overhead shower featuring AirPower technology generates a rain of voluminous drops.



RainFlow: A full flood jet for a refreshing shower.



Whirl: When water starts to flow, the massage sprays swivel forwards, easily reaching the neck and shoulders.



Advantages and benefits

- Architectural highlight in the shower
- Greater coverage allows wider freedom of movement
- Three spray modes: RainAir, RainFlow and Whirl
- Spray modes can be changed conveniently from below
- Flood jet provides a shower feeling like being under a waterfall
- Flush installation on Basic iBox universal



Raindance® Rainmaker® Air 3jet
Overhead shower
600 mm
RainAir: 20 l/min
RainAir XL: 24 l/min
Whirl: 22 l/min
26117, -000 with light
26115, -000 without light (not shown)

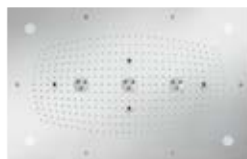

Raindance® Rainmaker® Air 3jet
Overhead shower
680 mm x 460 mm
RainAir: 20 l/min
RainAir XL: 24 l/min
Whirl: 22 l/min
28418, -000 with light
28417, -000 without light (not shown)



Raindance® 260 Air 1jet
Overhead shower
260 mm x 260 mm, flush ceiling installation possible
26472, -000 (17 l/min)
26481, -000 (9 l/min) EcoSmart

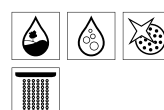
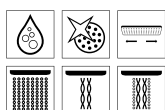
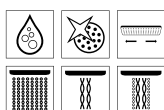

Raindance® Rainfall® 240 Air 3jet
Overhead shower
RainAir: 18 l/min
Whirl: 16 l/min
RainFlow: 28 l/min
28410, -000, -400 with light (not shown)
28411, -000, -400 without light
for iBox universal



Raindance® Rainfall® 180 Air 2jet
Overhead shower
RainAir: 16 l/min
RainFlow: 24 l/min
28433, -000, -400
for iBox universal

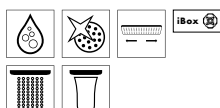

Raindance® Rainfall® 150 1jet
Overhead shower (18 l/min)
26442, -000



Raindance® Rainfall® Stream 150 1jet
Overhead shower (18 l/min)
26443, -000

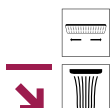

- Full flood jet
- For showering pleasure like being under a waterfall

- Parallel jets of sparkling water right down to the floor
- For showering pleasure like being under a waterfall



All specified flow rates are based on an operating pressure of 0.3 MPa (3 bar).

Raindance® Select E 300 3jet Showerpipe



The complete system for all showering needs



Select
Select the spray types

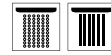

RainStream: Twelve jets of sparkling water that run parallel right down to the floor. For the same fascinating shower effects at every installation height and for every body size.



Select
Select the spray types

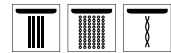

Select
Select the hand shower

Select
Select the overhead shower

Select
Switch RainStream on and off on the overhead shower



Setting the temperature

Raindance® Select E 300 3jet
Showerpipe





Advantages and benefits

- Complete system with overhead shower, hand shower and thermostat
- Intuitive control concept, pleasure at the touch of a button
- Installation possible on existing connections, so ideal solution for bathroom refurbishments with minimal effort
- Six spray modes: three from the overhead shower, three from the hand shower
- Overhead shower including RainStream with twelve parallel jets

Find out more at <http://pro.hansgrohe-int.com/select>

Hansgrohe Showerpipes

The Showerpipe range at a glance

	Crometta®	Croma®		Croma®	
					
Product name	Crometta® 160 1jet Showerpipe	Croma® 160 1jet Showerpipe	Croma® 220 1jet Showerpipe	Croma® Select S 180 2jet Showerpipe	
Versions	Shower with thermostat	# 27264, -400	# 27135, -000	# 27185, -000	# 27253, -400
	Shower with EcoSmart thermostat (9 l/min)	# 27265, -400	# 27238, -000	# 27188, -000	# 27254, -400
	Shower with single lever mixer	# 27266, -400	# 27154, -000	# 27222, -000	# 27255, -400
	Bath with thermostat	-	-	# 27223, -000	# 27531, -400
	Reno bath/shower	-	-	# 27224, -000	-
Overhead shower	Overhead shower	Crometta 160 1jet	Croma 160 1jet	Croma 220 1jet	Croma Select S 180 2jet
	Size of overhead shower	Ø 160 mm	Ø 160 mm	Ø 220 mm	Ø 180 mm
	Overhead shower spray types	Rain	Rain	RainAir	Rain IntenseRain
	Flow at 3 bar	18 l/min	17 l/min	19 l/min	17 l/min
	Select changeover of spray types	-	-	-	■
Features	Spray face removable for cleaning	-	-	■	-
	Swivel shower arm	-	-	■	■
	Length of shower arm	350 mm	270 mm	400 mm	400 mm
	Hand shower	Crometta 100 Vario	Croma 100 Vario	Croma 100 Vario	Croma Select S Multi
	Shower hose	Isiflex 160 cm	Isiflex 160 cm	Isiflex 160 cm	Isiflex 160 cm
Uniques	Thermostat	Ecostat Universal	Ecostat Comfort	Ecostat Comfort	Ecostat Comfort
	Riser pipe can be shortened	■	■	■	■
	Select	-	-	-	■
	AirPower	-	-	■	-
	QuickClean	■	■	■	■

■ Available. - Not available.

a® Select

Raindance®

Raindance® Select S



Croma® Select E 180 2jet Showerpipe	Raindance® 240 Air 1jet Showerpipe	Raindance® Select S 240 1jet Showerpipe	Raindance® Select S 240 2jet Showerpipe	Raindance® Select S 300 1jet Showerpipe
# 27256, -400	# 27145, -000	# 27115, -000	# 27129, -000, -400	# 27114, -000
# 27257, -400	-	# 27116, -000	-	-
# 27258, -400	-	-	-	-
# 27352, -400	-	# 27117, -000	-	-
-	-	-	-	-
Croma Select E 180 2jet	Raindance 240 Air 1jet	Raindance Select S 240 Air 1jet	Raindance Select S 240 2jet	Raindance Select S 300 Air 1jet
Ø 180 mm	Ø 240 mm	Ø 240 mm	Ø 240 mm	Ø 300 mm
Rain IntenseRain	RainAir	RainAir	RainAir Rain	RainAir
17 l/min	17 l/min	17 l/min	15 l/min	17 l/min
■	-	-	■	-
-	-	-	■	-
■	■	■	■	■
400 mm	460 mm	460 mm	460 mm	460 mm
Croma Select E Multi	Raindance S 100 Air 3jet	Raindance Select S 150	Raindance Select S 120 2jet	Raindance Select S 150 3jet
Isiflex 160 cm	Isiflex 160 cm	Isiflex 160 cm	Isiflex 160 cm	Isiflex 160 cm
EcoStat Comfort	EcoStat concealed	EcoStat Comfort	EcoStat Comfort	EcoStat Comfort
■	■	■	■	■
■	-	■	■	■
-	■	■	■	■
■	■	■	■	■

Raindance® Select E



Raindance® Select S 300 2jet Showerpipe	Raindance® Select E 360 Showerpipe	Raindance® Select E 300 2jet Showerpipe	Raindance® Select E 360 ST Showerpipe	Raindance® Select E 300 2jet ST Showerpipe
# 27133, -000, -400	# 27112, -000, -400	# 27128, -000, -400	# 27288, -000, -400	# 27126, -000, -400
-	# 27286, -000, -400	# 27282, -000, -400	# 27287, -000, -400	# 27283, -000, -400
-	-	-	-	-
-	# 27113, -000, -400	-	-	-
-	-	-	-	-
Raindance Select S 300 2jet	Raindance E 360 Air 1jet	Raindance Select E 300 2jet	Raindance E 360 Air 1jet	Raindance Select E 300 2jet
Ø 300 mm	360 mm x 190 mm	300 mm x 160 mm	360 mm x 190 mm	300 mm x 160 mm
RainAir Rain	RainAir	RainAir Rain	RainAir	RainAir Rain
15 l/min	17 l/min	17 l/min	17 l/min	16 l/min
■	-	■	-	■
■	-	■	-	■
■	-	-	-	-
460 mm	380 mm	380 mm	380 mm	380 mm
Raindance Select S 120 3jet	Raindance Select E 120 3jet	Raindance Select E 120 3jet	Raindance Select E 120 3jet	Raindance Select E 120 3jet
Isiflex 160 cm	Isiflex 160 cm	Isiflex 160 cm	Isiflex 160 cm	Isiflex 160 cm
EcoStat Comfort	EcoStat Select	EcoStat Select	ShowerTablet Select 300	ShowerTablet Select 300
■	-	-	-	-
■	■	■	■	■
■	■	■	■	■
■	■	■	■	■

Raindance® E

Rainmaker® Select



Raindance® Select E 300 3jet Showerpipe	Raindance® E 420 2jet Showerpipe	Rainmaker® Select 420 2jet Showerpipe	Rainmaker® Select 460 2jet Showerpipe	Rainmaker® Select 460 3jet Showerpipe
# 27127, -000, -400	# 27149, -000	# 27168, -400	# 27109, -400	# 27106, -400
-	-	-	# 27028, -400	# 27029, -400
-	-	-	-	-
-	-	-	-	-
-	-	-	-	-
Raindance Select E 300 3jet	Raindance E 420 Air 2jet	Raindance E 420 2jet	Rainmaker Select 460 2jet	Rainmaker Select 460 3jet
300 mm x 190 mm	420 mm x 220 mm	420 mm x 220 mm	460 mm x 300 mm	460 mm x 300 mm
RainAir Rain RainStream	RainAir RainFlow	RainAir RainFlow	Rain XL RainStream	Rain XL RainStream Mono
19 l/min	22 l/min	22 l/min	22 l/min	22 l/min
■	-	-	-	-
■	-	■	■	■
-	-	-	-	-
380 mm	450 mm	450 mm	450 mm	450 mm
Raindance Select E 120 3jet	PuraVida 120 1jet	Raindance Select S 120	Raindance Select S 120	Raindance Select S 120
Isiflex 160 cm	Isiflex 160 cm	Isiflex 160 cm	Isiflex 160 cm	Isiflex 160 cm
ShowerTablet Select 300	Ecostat	ShowerTablet Select 700	ShowerTablet Select 700	ShowerTablet Select 700
-	-	-	-	-
■	■	■	■	■
■	■	■	■	■
■	■	■	■	■

Croma® Select S 180 2jet Showerpipe



Set to all-round comfort

Select

Select the spray types



Rain: a strong spray to freshen up and for hair-washing.



IntenseRain: a powerful spray for a revitalising start to the day.



Modern design in a white/chrome finish

Select

Select the spray types



SoftRain: a soft water spray that caresses the body for that feel-good sensation.

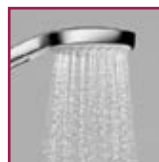

Long attachment for safe, simple fastening of the hand shower

IntenseRain: an intensive water spray that is ideal for rinsing out shampoo.



Massage: a concentrated spray with a great refreshing effect.



Ecostat Comfort with the ergonomic, durable metal pin handle for clear adjustment of the temperature

Croma® Select S 180 2jet Showerpipe



Advantages and benefits

- Complete system with overhead shower, hand shower and thermostat
- Overhead shower swivels, so can be positioned as desired independently of the connections
- Select technology to change the spray type at the touch of a button
- Five spray types: two from the overhead shower, three from the hand shower
- Can be fitted to existing connections, so ideal for bathroom refurbishments
- Also available in the EcoSmart version with only 9 l/min

Rainmaker® Select

NEW

Shower



Rainmaker® Select 460 3jet

Showerpipe
with Rainmaker Select 460 3jet overhead shower
(Rain XL: 18 l/min, RainStream: 19 l/min, Mono: 16 l/min),
Raindance Select S 120 3jet hand shower (14 l/min)
and ShowerTablet Select 700 thermostat,
shower arm 450 mm
27106, -400
27029, -400 (9 l/min) EcoSmart

Rainmaker® Select 460 2jet

Showerpipe
with Rainmaker Select 460 2jet overhead shower
(Rain XL: 18 l/min, RainStream: 19 l/min),
Raindance Select S 120 3jet hand shower (14 l/min)
and ShowerTablet Select 700 thermostat,
shower arm 450 mm
27109, -400
27028, -400 (9 l/min) EcoSmart

Rainmaker® Select 420 2jet

Showerpipe
with Raindance E 420 2jet overhead shower
(RainAir: 17 l/min, RainFlow: 21 l/min),
Raindance Select S 120 3jet hand shower (14 l/min)
and ShowerTablet Select 700 thermostat,
shower arm 400 mm
27168, -400

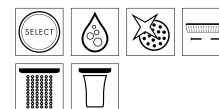
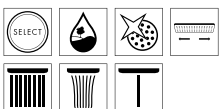

Raindance® Select E

Shower



Raindance® Select E 300 3jet
 Showerpipe
 with Raindance Select E 300 3jet overhead shower
 (Rain/RainAir: 16 l/min, RainStream: 19 l/min),
 Raindance Select E 120 3jet hand shower (16 l/min)
 and ShowerTablet Select 300 thermostat,
 shower arm 380 mm
 # 27127, -000, -400



Raindance® Select E 300 ST
 Showerpipe
 with Raindance Select E 300 2jet overhead shower
 (16 l/min), Raindance Select E 120 3jet hand shower
 (16 l/min) and ShowerTablet Select 300 thermostat,
 shower arm 380 mm
 # 27126, -000, -400
 # 27283, -000, -400 (9 l/min) EcoSmart



Raindance® Select E 360 ST
 Showerpipe
 with Raindance E 360 1jet overhead shower (17 l/min),
 Raindance Select E 120 3jet hand shower (16 l/min)
 and ShowerTablet Select 300 thermostat,
 shower arm 380 mm
 # 27288, -000, -400
 # 27287, -000, -400 (9 l/min) EcoSmart

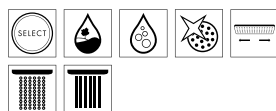
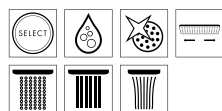

Raindance® Select E

Shower



Raindance® Select E 300 2jet

Showerpipe
with Raindance Select E 300 2jet overhead shower
(17 l/min), Raindance Select E 120 3jet hand shower
(16 l/min) and Ecostat Select thermostat,
shower arm 380 mm
27128, -000, -400
27282, -000, -400 (9 l/min) EcoSmart



Raindance® Select E 360 1jet

Showerpipe
with Raindance E 360 1jet overhead shower (17 l/min),
Raindance Select E 120 3jet hand shower (16 l/min)
and Ecostat Select thermostat, shower arm 380 mm
27112, -000, -400
27116, -000 (9 l/min) EcoSmart

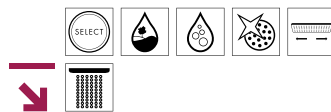
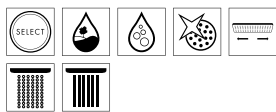

- Rectangular shower with shoulder width rain for full body coverage

Raindance® Select S

Shower



Raindance® Select S 300 2jet
 Showerpipe
 with swivelling Raindance Select S 300 2jet overhead
 shower (15 l/min), Raindance Select S 120 3jet hand
 shower (16 l/min) and Ecostat Comfort thermostat,
 shower arm 460 mm
 # 27133, -000, -400
 Height of the Showerpipe can be reduced

Raindance® Select S 240 2jet
 Showerpipe
 with swivelling Raindance Select S 240 2jet overhead
 shower (15 l/min), Raindance Select S 120 3jet hand
 shower (16 l/min) and Ecostat Comfort thermostat,
 shower arm 460 mm
 # 27129, -000, -400 (not shown)
 Height of the Showerpipe can be reduced



Raindance® Select S 300 1jet
 Showerpipe
 with swivelling Raindance S 300 1jet overhead
 shower (17 l/min), Raindance Select S 120 3jet hand
 shower (16 l/min) and Ecostat Comfort thermostat,
 shower arm 460 mm
 # 27114, -000
 Height of the Showerpipe can be reduced



Raindance® Select S 240 1jet
 Showerpipe
 with swivelling Raindance S 240 1jet overhead
 shower (17 l/min), Raindance Select S 120 3jet hand
 shower (16 l/min) and Ecostat Comfort thermostat,
 shower arm 460 mm
 # 27115, -000
 Height of the Showerpipe can be reduced

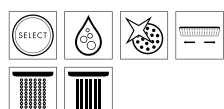

- Overhead shower can be swivelled away for soaping or washing hair
- Off-centre installation possible



- Overhead shower can be swivelled away for soaping or washing hair
- Off-centre installation possible

Raindance® E/Raindance®

Shower/Universal



Raindance® E 420 2jet
 Showerpipe
 with Raindance E 420 2jet overhead shower
 (RainAir: 18 l/min, RainFlow: 22 l/min),
 baton hand shower 1jet (16 l/min)
 and thermostat, shower arm 380 mm
 # 27149, -000



Raindance® 240 Air 1jet
 Showerpipe
 with swivelling overhead shower Raindance
 S 240 Air 1jet (17 l/min), Raindance S 100 Air 3jet
 hand shower (13 l/min) and concealed thermostat,
 shower arm 460 mm
 # 27145, -000
 Height of the Showerpipe can be reduced



Raindance® Connect S 240 Air 1jet
 Showerpipe
 with Raindance S 240 Air 1jet overhead shower
 (14 l/min), baton hand shower 2jet (17 l/min)
 # 27164, -000 Shower arm 460 mm
 # 27421, -000 Shower arm 350 mm (not shown)
 # 27158, -000 Corner installation set (not shown)
 Height of the Showerpipe can be reduced

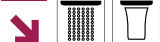

- With concentrated flood jet



- Optimal for upgrading bathrooms with existing iBox universal installation
- Swivelling overhead shower



- Easy retrofit where hand shower is already installed
- Perfect for renovations

Croma® Select E

NEW

Shower/Bath



Croma® Select E 180 2jet
 Showerpipe
 with swivelling Croma Select E 180 2jet overhead
 shower (Rain/IntenseRain: 16 l/min), Croma Select E
 Multi hand shower (13 l/min) and Ecostat Comfort
 thermostat, shower arm 400 mm
 # 27256, -400
 # 27257, -400 (9 l/min) EcoSmart
 Height of the Showerpipe can be reduced

Croma® Select E 180 2jet
 Showerpipe
 with swivelling Croma Select E 180 2jet overhead
 shower (Rain/IntenseRain: 16 l/min), Croma Select E
 Multi hand shower (13 l/min) and single lever mixer,
 shower arm 400 mm
 # 27258, -400
 Height of the Showerpipe can be reduced

Croma® Select E Multi
 Semipipe
 with Croma Select E Multi hand shower (16 l/min)
 and Ecostat Comfort thermostat
 # 27248, -400
 # 27259, -400 (9 l/min) EcoSmart

Croma® Select E 180 2jet
 Showerpipe
 # 27352, -400 with Ecostat Comfort bath thermostat
 (not shown)
 Height of the Showerpipe can be reduced

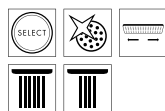

- The bar doubles as a handle for safe showering
- Solid attachment, ideal for hotels

Croma® Select S

NEW

Shower/Bath



Croma® Select S 180 2jet
 Showerpipe
 with swivelling Croma Select S 180 2jet overhead shower (Rain/IntenseRain: 16 l/min), Croma Select S Multi hand shower (13 l/min) and Ecostat Comfort thermostat, shower arm 400 mm
 # 27253, -400
 # 27254, -400 (9 l/min) EcoSmart
 Height of the Showerpipe can be reduced

Croma® Select S 180 2jet
 Showerpipe
 with swivelling Croma Select S 180 2jet overhead shower (Rain/IntenseRain: 16 l/min), Croma Select S Multi hand shower (13 l/min) and single lever mixer, shower arm 400 mm
 # 27255, -400
 Height of the Showerpipe can be reduced

Croma® Select S Multi
 Semipipe
 with Croma Select S Multi hand shower (16 l/min) and Ecostat Comfort thermostat
 # 27247, -400
 # 27249, -400 (9 l/min) EcoSmart

Croma® Select S 180 2jet
 Showerpipe
 # 27351, -400 with Ecostat Comfort bath thermostat (not shown)
 Height of the Showerpipe can be reduced

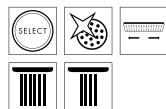
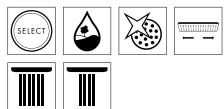

- The bar doubles as a handle for safe showering
- Solid attachment, ideal for hotels

Croma® 220

Shower



Croma® 220 Air 1jet
 Showerpipe
 with swivelling Croma 220 Air 1jet overhead shower
 (19 l/min), Croma 100 Vario hand shower
 (15 l/min) and Ecostat Comfort thermostat,
 shower arm 400 mm
 # 27185, -000
 # 27188, -000 EcoSmart
 Height of the Showerpipe can be reduced



Croma® 220 Air 1jet
 Showerpipe
 with swivelling Croma 220 Air 1jet overhead shower
 (19 l/min), Croma 100 Vario hand shower
 (15 l/min) and single lever mixer,
 shower arm 400 mm
 # 27222, -000
 Height of the Showerpipe can be reduced



Croma® 220 Air 1jet
 Showerpipe Reno
 with swivelling Croma 220 Air 1jet overhead shower
 (16 l/min), Croma 100 Vario hand shower (15 l/min),
 without mixer, shower arm 400 mm
 # 27224, -000
 # 27158, -000 Corner installation set (not shown)
 Height of the Showerpipe can be reduced



- Overhead shower can be swivelled away for soaping or washing hair
- Off-centre installation possible



- Easy retrofit on existing mixers
- Swivelling overhead shower

Croma® 160

Shower



Croma® 160 1jet
 Showerpipe
 with Croma 160 1jet overhead shower (17 l/min),
 Croma 100 Vario hand shower (15 l/min)
 and Ecostat Comfort thermostat, shower arm 270 mm
 # 27135, -000
 # 27238, -000 (9 l/min) EcoSmart
 Height of the Showerpipe can be reduced

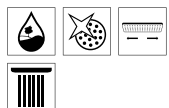

Croma® 160 1jet
 Showerpipe
 with Croma 160 1jet overhead shower (17 l/min),
 Croma 100 Vario hand shower (15 l/min)
 and single lever mixer, shower arm 270 mm
 # 27154, -000
 Height of the Showerpipe can be reduced

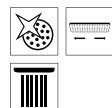

Crometta® 160

NEW

Shower



Crometta® 160 1jet
 Showerpipe
 with overhead shower Crometta 160 1jet, Crometta
 100 Vario hand shower and Ecostat Universal
 thermostat
 # 27264, -400
 # 27265, -400 (9 l/min) EcoSmart
 Height of the Showerpipe can be reduced

Crometta® 160 1jet
 Showerpipe
 with overhead shower Crometta 160 1jet, Crometta
 100 Vario hand shower and single lever mixer
 # 27266, -400 (not shown)
 Height of the Showerpipe can be reduced

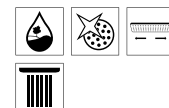

Raindance® Select E/Raindance® Select S/Croma®

Bath



Raindance® Select E 360 1jet
Showerpipe
with Raindance E 360 1jet overhead shower
(17 l/min), Raindance Select E 120 3jet hand shower
(16 l/min) and Ecostat Select bath thermostat
(20 l/min), shower arm 380 mm
27113, -000, -400



Raindance® Select S 240 1jet
Showerpipe
with swivelling Raindance S 240 1jet overhead
shower (17 l/min), Raindance Select S 120 3jet hand
shower (16 l/min) and Ecostat Comfort bath thermostat
(20 l/min), shower arm 460 mm
27117, -000
Height of the Showerpipe can be reduced



Croma® 220 Air 1jet
Showerpipe
with swivelling Croma 220 Air 1jet overhead shower
(17 l/min), Croma 100 Vario hand shower
(15 l/min), Ecostat Comfort bath thermostat
(20 l/min), shower arm 400 mm
27223, -000
Height of the Showerpipe can be reduced



- Full showering in the bath
- Also ideal for renovations



- Optimal installation also on side or offset connections
- Swivelling overhead shower



- Overhead shower can be swivelled away for soaping or washing hair
- Off-centre installation possible

Hansgrohe Showerpanel®

Made to convince customers on all fronts

Overhead, hand and side showers, various spray types and refreshing all-body massages from the side showers: A Hansgrohe

Showerpanel provides water fun all the way. The fun finds its perfect complement in the uncomplicated installation: Simply retrofit on

the existing connections – wall installations are not necessary. The bathroom will therefore be equipped for shower pleasure in seconds.



200 mm



Raindance® Lift Showerpanel®
with Raindance Rainfall 180 Air 2jet overhead shower (RainAir: 14 l/min, RainFlow: 17 l/min), PuraVida 120 1jet baton hand shower (16 l/min) and thermostat, height adjustable, 200 mm
27008, -000, -400
27003, -400 (9 l/min) EcoSmart

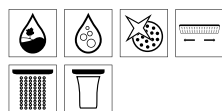

200 mm

Lift 2 Showerpanel®
with Raindance S 180 Air 1jet overhead shower (22 l/min), PuraVida baton hand shower, 6 side showers and thermostat, height adjustable, 200 mm
26871, -000

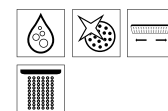

Advantages and benefits

- Combines overhead, hand, and/or side showers in a single system
- Water fun from all sides
- Up to six side showers
- Various spray types for individual showering enjoyment



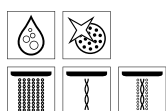

Raindance® S Showerpanel®
with Raindance S 150 Air 3jet hand
shower (17 l/min), 6 side showers
and exposed thermostat
27005, -000



- Straightforward installation with no need to integrate in the wall
- Easy to retrofit on existing connections
- Some versions are height adjustable to suit all body sizes

Hansgrohe exposed thermostats

The exposed thermostats at a glance

	Ecostat® Universal		Ecostat® 1001 SL		Ecostat® Comfort	
						
Product name	Ecostat® Universal		Ecostat® 1001 SL		Ecostat® Comfort	
Areas of use	Bath	Shower	Bath	Shower	Bath	Shower
Item no.	# 13123, -000	# 13122, -000	# 13241, -000	# 13261, -000	# 13114, -000	# 13116, -000
Scald protection at 40°C	■	■	■	■	■	■
Adjustable temperature limit	■	■	■	■	■	■
Ecostop button	-	■	-	■	-	■
Flow connection hand shower at 3 bar	30 l/min	30 l/min	30 l/min	30 l/min	30 l/min	30 l/min
Flow bath filler at 3 bar	20 l/min		20 l/min		20 l/min	
Change spray type with Select button	-	-	-	-	-	-
Turn to change spray type	■	■	■	■	■	■
Insulated water channel	-	-	-	-	-	-
Shelf made of safety glass	-	-	-	-	-	-
Concealed connection for one function	-	-	-	-	-	-
Uniques	Select	-	-	-	-	-
	AirPower	■	-	■	-	■
	QuickClean	■	-	■	-	■

■ Available. - Not available.

Ecostat® Select

ShowerTablet® Select 300

ShowerTablet® Select 700



Ecostat® Select		ShowerTablet® Select 300		ShowerTablet® Select 700	
Bath	Shower	Bath	Shower	Bath	Universal
# 13141, -000	# 13161, -000	# 13151, -000, -400	# 13171, -000, -400	# 13183, -000, -400	# 13184, -000, -400
▪	▪	▪	▪	▪	▪
▪	▪	▪	▪	▪	▪
-	▪	-	▪	-	▪
30 l/min	30 l/min	30 l/min	30 l/min	30 l/min	30 l/min
20 l/min		20 l/min		20 l/min	
-	-	▪	▪	▪	▪
▪	▪	-	-	-	-
▪	▪	▪	▪	▪	▪
▪	▪	▪	▪	▪	▪
-	-	-	-	-	▪
-	-	▪	▪	▪	▪
▪	-	▪	-	▪	-
▪	-	▪	-	▪	-

ShowerTablet® Select



The thermostat that redefines easy use

Thanks to the intuitive Select technology everything on the ShowerTablet Select 300 almost happens by itself: Whether you are switching the hand shower on or off in the shower, using the shower or bath filler in the

bathtub, or doing all of these: A simple touch of the button is all it takes to select the function. The Select elements are all easy to operate from the front. Large prints and contrasting colours make it even easier. The control button

is raised when the unit is switched on. This means that it is instantly obvious which function is active. The large, high quality glass shelf is resistant to commercially available bathroom cleaners so will last a lifetime.

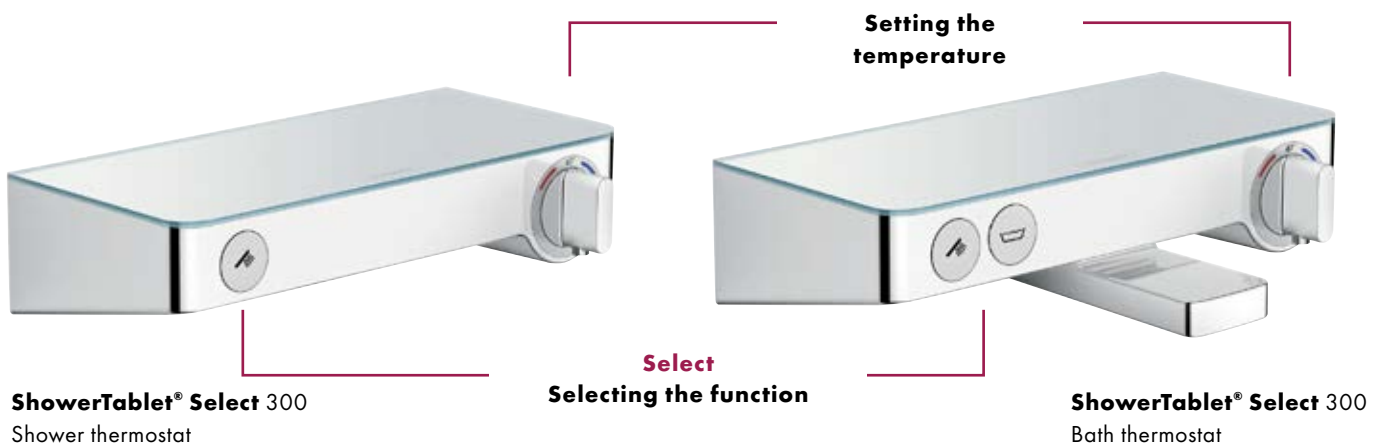

White shelf

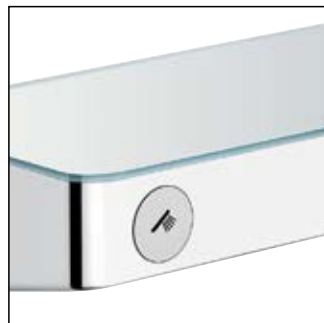

Mirrored chrome shelf



Also available as the **ShowerTablet® Select 700**, 700 mm wide, and with the option of selecting two functions. So this version can be used for the elegant concealed installation of a single-spray overhead shower.



Advantages and benefits

- Simply touch the button to select the function
- The active function can be recognised immediately by the raised control button
- All Select elements can be reached easily from the front
- More than one function can be selected at the same time



Intuitive: Thanks to the Select button and temperature control, control is intuitive and easy from the front.



User-friendly: The desired temperature can be set precisely with the handy turn control.



Easy to use: When switched on, the control button is raised – so the active function can be identified at a glance.



Clear: Easy to understand, abrasion-resistant symbols make control easier.



Safe: The insulated body with rounded corners protects against heat and knocks.



Attractive: The unique design makes the ShowerTablet Select 300 an eye-catcher in the bathroom.



Practical: The level surface is made of glass and offers plenty of space for toiletries.



Easy cleaning: The housing is sealed to keep dirt out, and the smooth surface is easy to clean.

- Easy to understand, wear resistant symbols for ease of operation
- The level surface is made of safety glass, and offers space for toiletries.
- **Easy to clean:** thanks to the smooth glass surface that is resistant to chemical cleaning agents
- Integrates harmoniously in any shower area

Ecostat® Select



Design and lots of fun

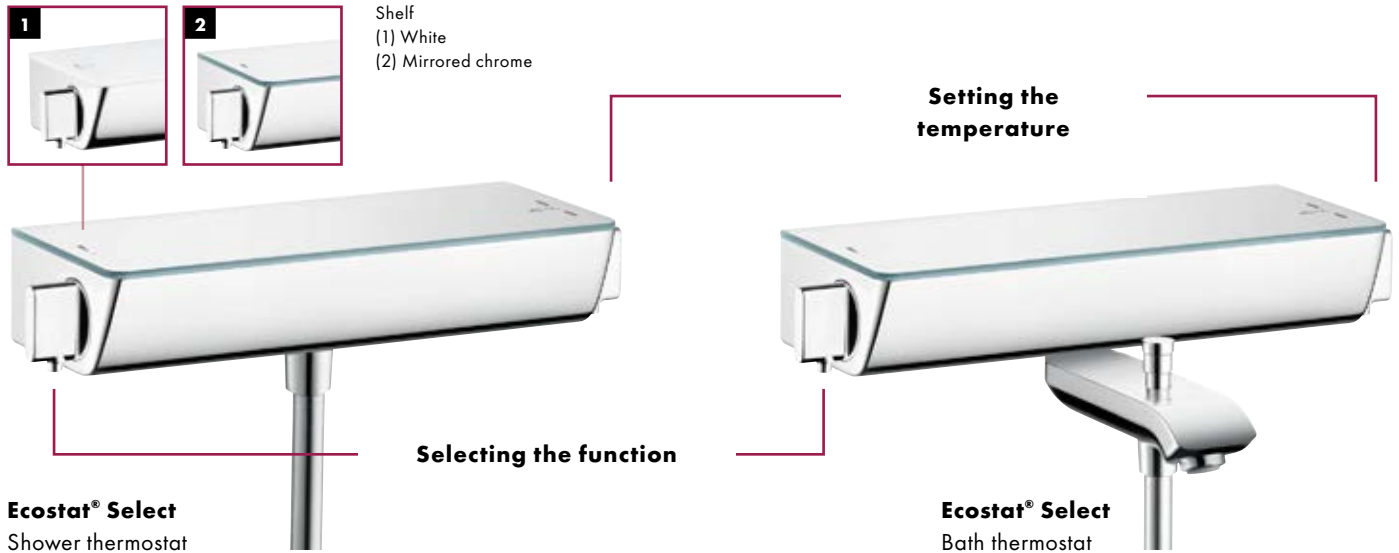

Safe: The temperature lock prevents hot water from scalding. In addition, the elegant body is highly insulated. Rounded edges minimise the risk of painful knocks.



Practical: The level surface is made of safety glass and offers space for toiletries.



Economical: With integrated EcoSmart technology, the flow rate is limited to 10 l/min, for an efficient and refreshing shower.



User-friendly: Constant water quantities and temperatures on the highest level of intuitive operability.



Advantages and benefits

- Visual highlight
- Insulated body remains cool to the touch preventing the risk of injury
- Safe and easy to use for all age groups
- Shelf to store your favourite toiletries
- Water savings made easy
- **Easy cleaning**

Bath

NEW



ShowerTablet® Select 700
Thermostatic bath/shower mixer
13183, -000, -400



ShowerTablet® Select 300
Thermostatic bath/shower mixer
13151, -000, -400



Ecostat® Select
Thermostatic bath/shower mixer
13141, -000, -400



Shower

NEW



ShowerTablet® Select 700
Thermostatic shower mixer
13184, -000, -400



ShowerTablet® Select 300
Thermostatic shower mixer
13171, -000, -400



Ecostat® Select
Thermostatic shower mixer
13161, -000, -400

Thermal disinfection possible
13162, -000 (not shown)

Shower combinations



**Raindance® Select E 120/
ShowerTablet® Select 300 Combi Set**
Shower set with ShowerTablet Select thermostat
27027, -000, -400 0.90 m
27026, -000, -400 0.65 m (not shown)

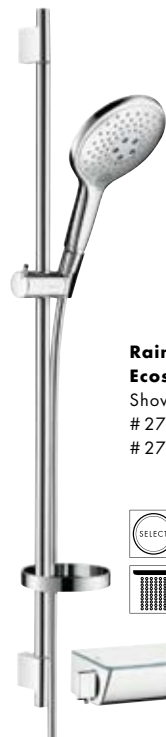
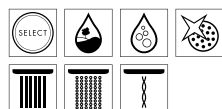

**Raindance® Select S 150/
Ecostat® Select S Combi Set**
Shower set with Ecostat Select thermostat
27037, -000, -400 0.90 m
27036, -000, -400 0.65 m (not shown)

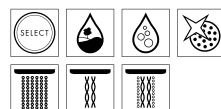

**Raindance® Select E 120/
Ecostat® Select Combi Set**
Shower set with Ecostat Select thermostat
27039, -000, -400 0.90 m
27038, -000, -400 0.65 m (not shown)

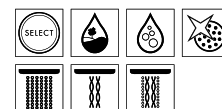

Ecostat® thermostats

All under control: Thermostatic technology for greater shower pleasure

Hansgrohe offers a large number of exposed thermostats. These not only upgrade the look of bathrooms, they also enhance the comfort of showering. They provide the convenient regulation of flow rate, water pressure and water temperature. Yet the distinct advantage of an exposed thermostat is: This mixer can be installed quickly and easily on existing connections.

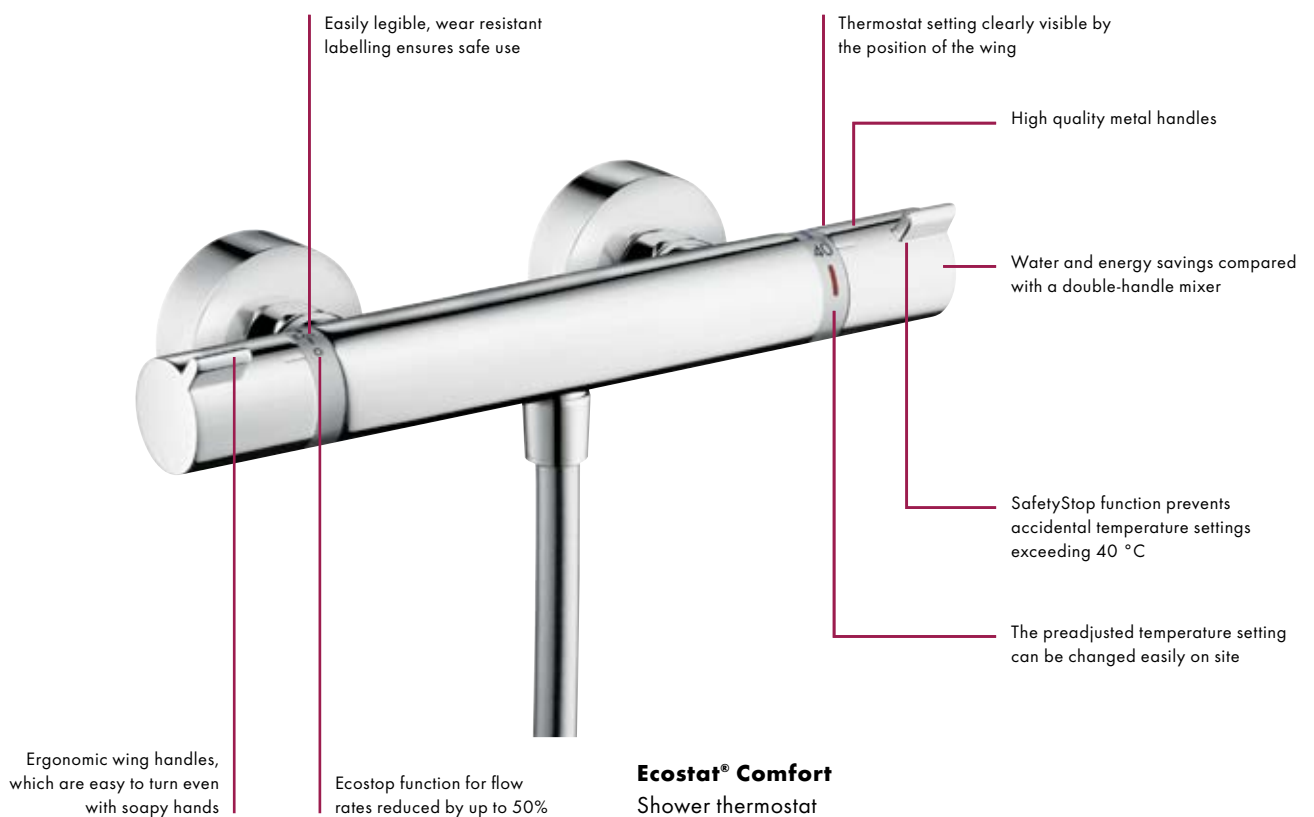

Advantages and benefits

- Visual and technical upgrade of the bathroom
- Water and energy savings compared with single lever mixers
- Convenient preset temperature
- Temperatures kept constant, so no scalding even when pressure/temperature fluctuates in the water supply

Bath



Ecostat® Comfort
Thermostatic bath/shower mixer
13114, -000



Ecostat® 1001 SL
Thermostatic bath/shower mixer
13241, -000



Ecostat® Universal
Thermostatic bath/shower mixer
13123, -000



Ecostat® Comfort Care
Thermostatic bath/shower mixer
13115, -000



Shower



Ecostat® Comfort
Thermostatic shower mixer
13116, -000



Ecostat® 1001 SL
Thermostatic shower mixer
13261, -000



Ecostat® Universal
Thermostatic shower mixer
13122, -000



Ecostat® Comfort Care
Thermostatic shower mixer
13117, -000

Shower combinations



Croma® Select E Vario Combi Set
with Ecostat Comfort thermostat
27082, -400 0.90 m
27081, -400 0.65 m (not shown)

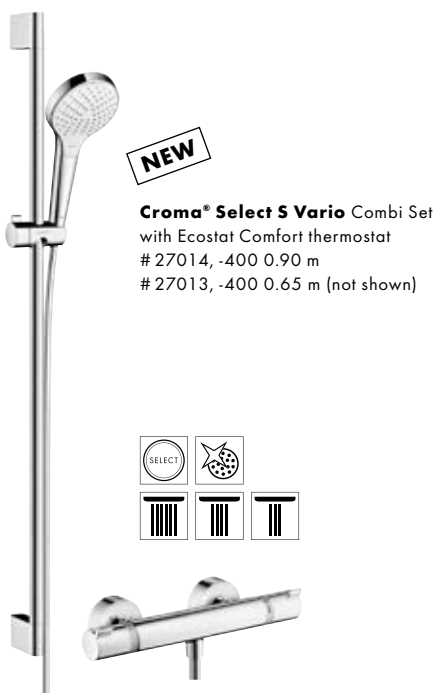
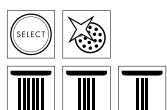

Croma® Select S Vario Combi Set
with Ecostat Comfort thermostat
27014, -400 0.90 m
27013, -400 0.65 m (not shown)



Croma® 100 Vario Combi Set
with Ecostat Comfort thermostat
27035, -000 0.90 m
27033, -000 0.90 m (9 l/min) EcoSmart
27034, -000 0.65 m (not shown)
27032, -000 0.65 m (9 l/min) EcoSmart (not shown)

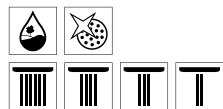

Croma® 100 Multi Combi Set
with Ecostat 1001 SL thermostat
27085, -000 0.90 m
27086, -000 0.65 m (not shown)

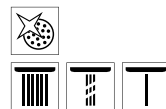

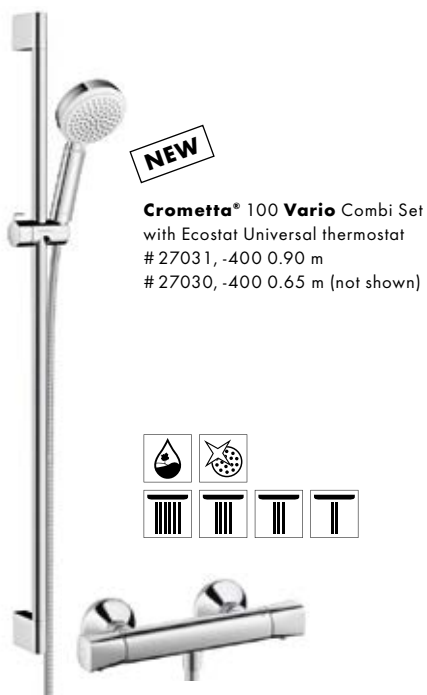

Crometta® 100 Vario Combi Set
with Ecostat Universal thermostat
27031, -400 0.90 m
27030, -400 0.65 m (not shown)



Crometta® 85 Vario Combi Set
with Ecostat Universal thermostat
27080, -000 0.90 m
27058, -000 0.65 m (not shown)



Advantages and benefits

- Two products combined in one
- Matched in looks and function
- Less expensive than purchasing separately
- Easy order process
- Easy to store



Under-basin thermostat
Exposed
15346, -000



- Easy to connect to existing valves, e.g. under the basin
- Provides a constant temperature and consistent flow even with fluctuating cold water pressure
- Safety e.g. in nursery schools, hospitals or hotels
- Safe for thermal disinfection

Hansgrohe concealed finish sets

NEW

The right solution for any bathroom

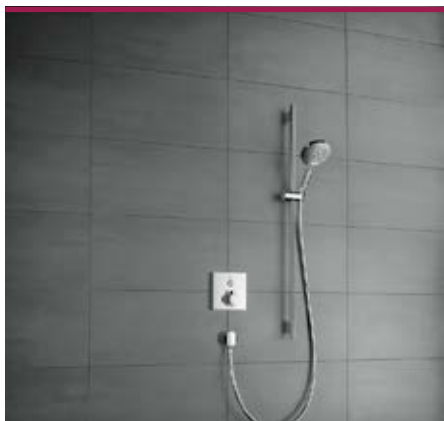

1 function



ShowerSelect® Thermostat



ShowerSelect®
Thermostat
15762, -000

ShowerSelect® Mixer



ShowerSelect®
Mixer
15767, -000

Ecostat® Thermostat



Ecostat® E
Thermostat
15707, -000

ShowerSelect® Thermostat



ShowerSelect® S
Thermostat
15744, -000

ShowerSelect® Mixer



ShowerSelect® S
Mixer
15747, -000

Ecostat® Thermostat



Ecostat® S
Thermostat
15757, -000

You will be able to satisfy any of your customers' requirements – and help them keep to their budgets – with Hansgrohe's complete concealed range for between one and four functions. The choice starts with the operation:

are the showers and spray types to be controlled conventionally by turning, or with complete ease at the touch of a button? Your customers also have complete freedom of design: the ShowerSelect is now also available

in a round design and as a mixer. Ecostat thermostats are available as a circle, and now also as a square with rounded corners. Plenty of options for attractive installations that blend beautifully with the bathroom.



ShowerSelect® Thermostat



ShowerSelect®
Thermostat
15763, -000



ShowerSelect®
Thermostat with
Fixfit and Porter
15765, -000

ShowerSelect® Mixer



ShowerSelect®
Mixer
15768, -000

Ecostat® Thermostat



Ecostat® E
Thermostat
15708, -000

ShowerSelect® Thermostat



ShowerSelect® S
Thermostat
15743, -000

ShowerSelect® Mixer



ShowerSelect® S
Mixer
15748, -000

Ecostat® Thermostat



Ecostat® S
Thermostat
15758, -000



3 functions



ShowerSelect®



ShowerSelect®
Valve
15764, -000



ShowerSelect®
Highflow Thermostat
15760, -000

Ecostat® Thermostat



iControl® E
Valve
15777, -000



Ecostat® E
Highflow Thermostat
15706, -000
Thermostat
15705, -000 (not shown)

Ecostat® Thermostat



Trio®/Quattro® E
Shut-off/diverter valve
15937, -000



Ecostat® E
Highflow Thermostat
15706, -000
Thermostat
15705, -000 (not shown)



Shut-off valve E
15978, -000

ShowerSelect®



ShowerSelect® S
Valve
15745, -000



ShowerSelect® S
Highflow Thermostat
15741, -000

Ecostat® Thermostat



iControl® S
Valve
15955, -000



Ecostat® S
Highflow Thermostat
15756, -000
Thermostat
15755, -000 (not shown)

Ecostat® Thermostat



Trio®/Quattro® S
Shut-off/diverter valve
15932, -000



Ecostat® S
Highflow Thermostat
15756, -000
Thermostat
15755, -000 (not shown)



Shut-off valve S
15972, -000



4 functions



ShowerSelect®



ShowerSelect®
Valve
15764, -000



ShowerSelect®
Highflow Thermostat
15761, -000

Ecostat® Thermostat



iControl® E
Valve
15777, -000



Ecostat® E
Highflow Thermostat
15706, -000



Shut-off valve E
15978, -000

Ecostat® Thermostat



Trio®/Quattro® E
Shut-off/diverter valve
15937, -000



Shut-off valve E
15978, -000



Ecostat® E
Highflow Thermostat
15706, -000



Shut-off valve E
15978, -000

ShowerSelect®



ShowerSelect® S
Valve
15745, -000



ShowerSelect® S
Highflow Thermostat
15742, -000

Ecostat® Thermostat



iControl® S
Valve
15955, -000



Ecostat® S
Highflow Thermostat
15756, -000



Shut-off valve S
15972, -000

Ecostat® Thermostat



Trio®/Quattro® S
Shut-off/diverter valve
15932, -000



Shut-off valve S
15972, -000



Ecostat® S
Highflow Thermostat
15756, -000



Shut-off valve S
15972, -000

ShowerSelect® Thermostat with Fixfit® and Porter

NEW

The easy way to control pleasure



ShowerSelect®

Thermostat with Fixfit and Porter
Escutcheon size 155 mm x 188 mm

Advantages and benefits

- Unique installation: integrated Fixfit hose connection and Porter for added comfort
- Optimum solution for the shower: no separate drilling for pipe connections or shower holder. Installation based on the iBox universal.
- Metal escutcheon, hose connection for all G ½ hoses
- Two-tone effect as a result of the contrast between chrome-coloured escutcheons and matt buttons. The easy-to-read temperature display makes operation much easier
- Manually adjustable temperature limit
- Simultaneous selection of both functions

ShowerSelect® Concealed finish sets



Operation in all its tremendous variety

ShowerSelect®

Thermostat for 2 functions
Escutcheon size 155 mm x 155 mm

NEW

ShowerSelect® S

Mixer for 2 functions
Escutcheon diameter 150 mm

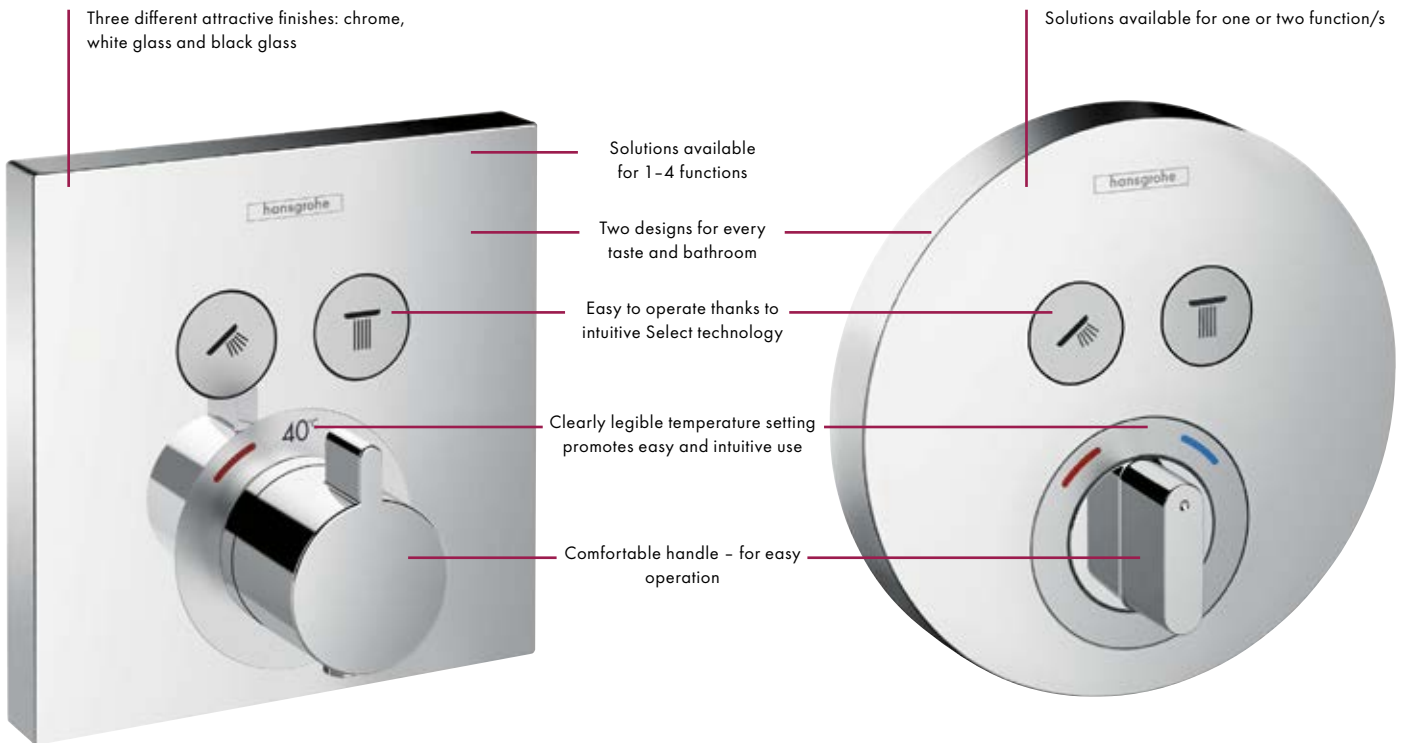

- Constant water temperature even with fluctuating water pressure
- Temperature limited at 40°C, a higher temperature can be set by touching the button on the underside of the handle
- Safe for thermal disinfection
- Plastic escutcheon and metal handle

- For pipes with stable water pressure
- Unique product: Mixer technology with a new handle design, so it can be used with any mixer and shower line
- Easy temperature adjustment
- The depth of the metal handle does not depend on the installation depth of the iBox universal
- Fluctuating water pressures are no problem for the high quality Hansgrohe cartridges



Advantages and benefits

- Two different technologies: thermostat or mixer
- Printed temperature and button displays will not rub off
- Combinations for any shower situation: pictogram buttons for choosing functions included
- Installation based on the iBox universal
- Recommended operating pressure of the Select valves between 0.1 and 0.5 MPa max.

Lots of advantages – lots of benefits



Intuitive: Easy-to-use Select buttons for intuitive, comfortable control – even for those with restricted mobility.



Clear: Easy to understand, abrasion-resistant symbols make control easier.



Easy to use: The protruding button instantly reveals the active function. Can be controlled using an elbow or fist thanks to the button extension that is included in the box.



User-friendly: The desired temperature can be set precisely with the user-friendly handle.



Easy cleaning: The flush-fit buttons leave a flat surface that is easy to clean.



Attractive: The rectangular shape blends perfectly with a tiled bathroom and will also go in many modern bathroom designs.



Economical: The easy-to-push button encourages the user to switch the water off frequently, which helps to save water.



User-friendly: The functions can all be used at the same time – for even greater shower pleasure.



Advantages and benefits

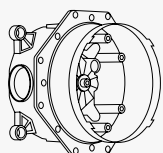

- Two different technologies: thermostat or mixer
- Available in a square or round design – for any taste, style and shower type
- Three attractive finishes: chrome, white glass and black glass; even more options in bathroom design, to appeal to even more potential customers
- Large symbols – for clarity

Attractive finishes for any ambience and taste



Chrome: the timeless classic for any bathroom.



White glass: Stylish and luxurious – an eye-catcher in the bathroom that matches any white/ chrome shower, and is especially effective when combined with the Rainmaker Select overhead showers and PuraVida basin mixers.



Black glass: Modern and elegant – a visual highlight in the bathroom that combines perfectly with chrome products.

- Intuitive, easy control at the touch of a button
- Functions can be switched off quickly and easily to save water
- Fast, easy and inexpensive renovations possible by simply replacing the existing finish sets
- High level of comfort by simultaneously setting several functions



The ShowerSelect finish set for 2 functions received not only the "Design Plus Award" and the "iF Award 2014", but also the award of the ZVSHK, the German Central Association Plumbing, Heating and Air Conditioning, for excellent design for users with restricted mobility.

Thermostats



ShowerSelect®
Thermostat for 1 function
15762, -000
Escutcheon size 155 mm x 155 mm



ShowerSelect®
Thermostat for 2 functions
15763, -000
Escutcheon size 155 mm x 155 mm



ShowerSelect®
Thermostat for 2 functions
with hose connection and shower
support (Hand shower and flexible
hose can be chosen freely)
15765, -000
Escutcheon size 155 mm x 188 mm



ShowerSelect®
Valve for 3 functions
15764, -000
Escutcheon size 155 mm x 155 mm



ShowerSelect®
Highflow thermostat
15760, -000
Escutcheon size 155 mm x 155 mm



ShowerSelect®
Highflow Thermostat for 1 function
(bottom) and 1 additional function (top)
15761, -000
Escutcheon size 155 mm x 155 mm



NEW

ShowerSelect®
Mixer for 1 function
15767, -000
Escutcheon size 155 mm x 155 mm



NEW

ShowerSelect®
Mixer for 2 functions
15768, -000
Escutcheon size 155 mm x 155 mm



Thermostats – Glass surface

NEW



- Elegant glass surface as a visual highlight
- Flush-fit buttons in the same glass blend seamlessly with the finish set
- The print on the buttons is permanent and will not rub off
- Suitable button combination already in place, special solutions available on request.
- Perfect interplay between the glass surface and shower partitions, mirrors and windows plus the new Rainmaker Select overhead showers for optimum integration in the bathroom
- Select technology for easy control at the touch of a button
- Easy installation based on the iBox universal
- Matches coloured push plates and designer wall-hung WCs



ShowerSelect®
Thermostat for 1 function
Glass surface
15762, -400, -600
Escutcheon size 155 mm x 155 mm



ShowerSelect®
Thermostat for 2 functions
Glass surface
15738, -400, -600
Escutcheon size 155 mm x 155 mm





NEW

ShowerSelect® S
Thermostat for 1 function
15744, -000
Escutcheon diameter 150 mm



NEW

ShowerSelect® S
Thermostat for 2 functions
15743, -000
Escutcheon diameter 150 mm



NEW

ShowerSelect® S
Valve for 3 functions
15745, -000
Escutcheon diameter 150 mm

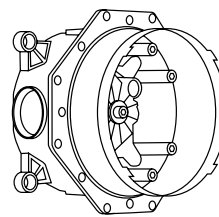

iBox® universal
Basic set iBox universal
01800180
Extension set 25 mm for too deep installation:
13595000
Extension set 22 mm for too low installation depths:
13593000 for ShowerSelect in the dimensions 155 mm x 155 mm
13597000 for ShowerSelect of diameter 150 mm



NEW

ShowerSelect® S
Highflow thermostat
15741, -000
Escutcheon diameter 150 mm



NEW

ShowerSelect® S
Highflow Thermostat for 1 function (bottom) and 1 additional function (top)
15742, -000
Escutcheon diameter 150 mm



NEW

ShowerSelect® S
Mixer for 1 function
15747, -000
Escutcheon diameter 150 mm



NEW

ShowerSelect® S
Mixer for 2 functions
15748, -000
Escutcheon diameter 150 mm



ShowerSelect®
Highflow thermostat
Glass surface
15734, -400, -600
Escutcheon size 155 mm x 155 mm



ShowerSelect®
Highflow Thermostat for 1 function (bottom) and 1 additional function (top)
Glass surface
15735, -400, -600
Escutcheon size 155 mm x 155 mm



ShowerSelect®
Valve for 3 functions
Glass surface
15736, -400, -600
Escutcheon size 155 mm x 155 mm



white/chrome version (-400)



black/chrome version (-600)

Ecostat® concealed finish sets

Established technology in a new design

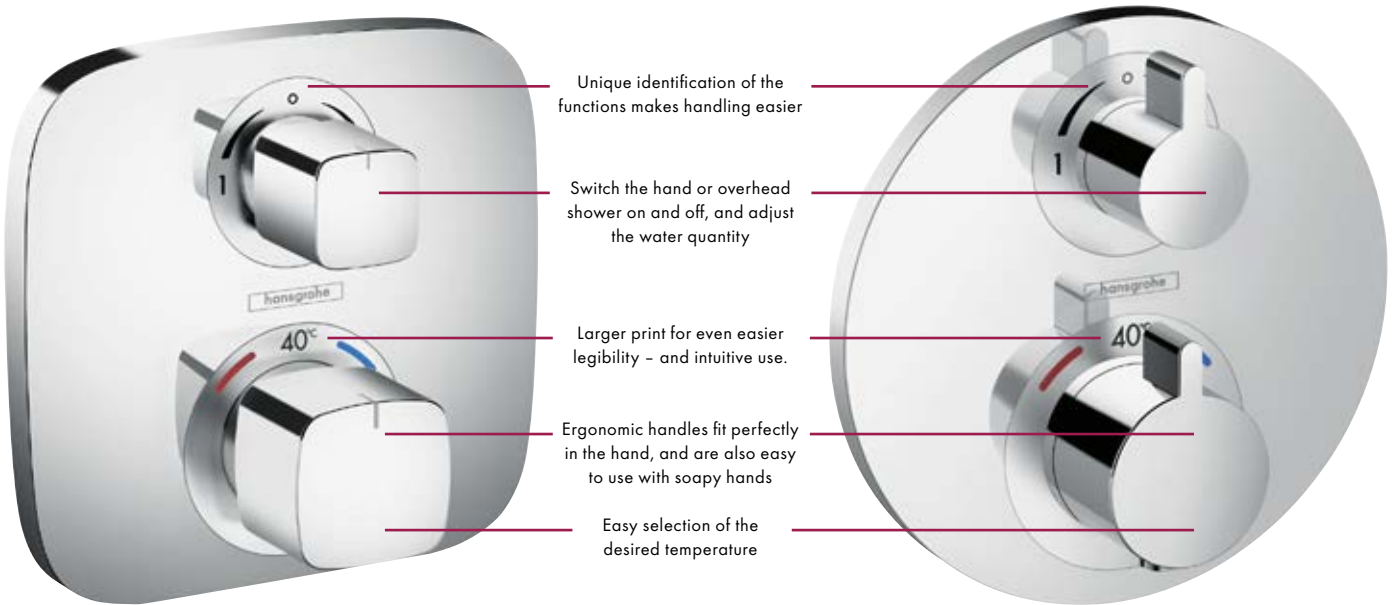

Ecostat® E: Thermostat in a square design with rounded corners.

Ecostat® S: Thermostat in a round design.



Easy to use: Unique identification of the functions makes handling easier.



Clear: Larger print for even easier legibility – and intuitive use.



Safe: Ergonomic handles fit perfectly in the hand, and are also easy to use with soapy hands.



Advantages and benefits

- Easy-to-use rotary control for choosing between hand and overhead shower and to control the water quantity
- Precise control of the water temperature – no nasty shocks for the user
- Two design options to suit any bathroom and spray form
- Constant water temperature thanks to thermostat technology
- Size-optimised handles for safe, easy operation



Ecostat® E
Thermostat for 1 function
15707, -000
Escutcheon size 155 mm x 155 mm



Ecostat® E
Thermostat for 2 functions
15708, -000
Escutcheon size 155 mm x 155 mm



Ecostat® E
Thermostat
15705, -000
Highflow thermostat
15706, -000 (not shown)
Escutcheon size 155 mm x 155 mm



iControl® E
Valve for 3 functions
15777, -000
Escutcheon size 155 mm x 155 mm



Ecostat® S
Thermostat for 1 function
15757, -000
Escutcheon diameter 150 mm



Ecostat® S
Thermostat for 2 functions
15758, -000
Escutcheon diameter 150 mm



Ecostat® S
Thermostat
15755, -000
Highflow thermostat
15756, -000 (not shown)
Escutcheon diameter 150 mm



iControl® S
Valve for 3 functions
15955, -000
Escutcheon diameter 150 mm

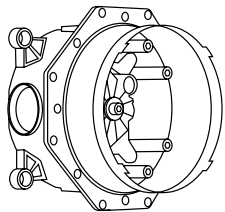

iBox® universal
Basic set iBox universal
01800180
Extension set 25 mm for too deep installation:
13595000
Extension set 22 mm for too low installation depths:
13597000 for escutcheons of diameter 150 mm
15597000 for escutcheons in the dimensions 155 mm x 155 mm



Ecostat® S
Thermostat for 1 function
15701, -000
Escutcheon diameter
170 mm



Ecostat® S
Thermostat for 2 functions
15721, -000
Escutcheon diameter
170 mm



Ecostat® S
Thermostat
15711, -000
Highflow thermostat
15715, -000
(not shown)
Escutcheon diameter
170 mm



Ecostat® Classic
Thermostat for 2 functions
15753, -000
Escutcheon diameter
170 mm

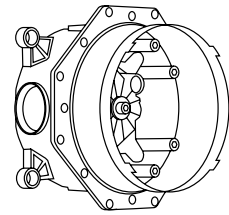

iBox® universal
Basic set iBox universal
01800180
Extension set 25 mm for too deep installation:
13595000
Extension set 22 mm for too low installation depths:
13596000 for escutcheons of diameter 170 mm
13597000 for escutcheons of diameter 150 mm
97407000 for escutcheons of diameter 172 mm
15597000 for PuraVida



PuraVida®
Thermostat for 1 function
15775, -000, -400
Escutcheon size
155 mm x 155 mm



PuraVida®
Thermostat for 2 functions
15771, -000, -400
Escutcheon size
155 mm x 155 mm



PuraVida®
Thermostat
15770, -000, -400
Highflow thermostat
15772, -000, -400
(not shown)
Escutcheon size
155 mm x 155 mm



PuraVida® iControl®
Valve for 3 functions
15777, -000, -400
Escutcheon size
155 mm x 155 mm



Metris®
Thermostat for 1 function
31572, -000
Escutcheon diameter
150 mm



Metris®
Thermostat for 2 functions
31573, -000
Escutcheon diameter
150 mm



Metris®
Thermostat
31570, -000
Highflow thermostat
31571, -000
(not shown)
Escutcheon diameter
150 mm



Metris® iControl®
Valve for 3 functions
31958, -000
Escutcheon diameter
150 mm

Valves



Trio®/Quattro®
Shut-off/diverter valve for PuraVida
15937, -000, -400



Shut-off valve
for PuraVida
15978, -000, -400



Trio®/Quattro® E
Shut-off/diverter valve
31634, -000



Shut-off valve E
31677, -000



Trio®/Quattro® S
Shut-off/diverter valve
15932, -000



Shut-off valve S
15972, -000



Shut-off valve
for Logis
71970, -000



Shut-off valve
for Logis Classic
71976, -000

iBox® universal

The universal basis for all concealed installation solutions

With the iBox universal, the mixer technology is concealed in the wall. This not only looks good, but also creates more space and thus greater shower pleasure. Another

advantage is the flexibility of the system and design. The iBox universal may be installed before the decision has been made for a shower system. As the basic set for any

Hansgrohe standard and thermostatic solutions, it is easy to change or upgrade at any time.

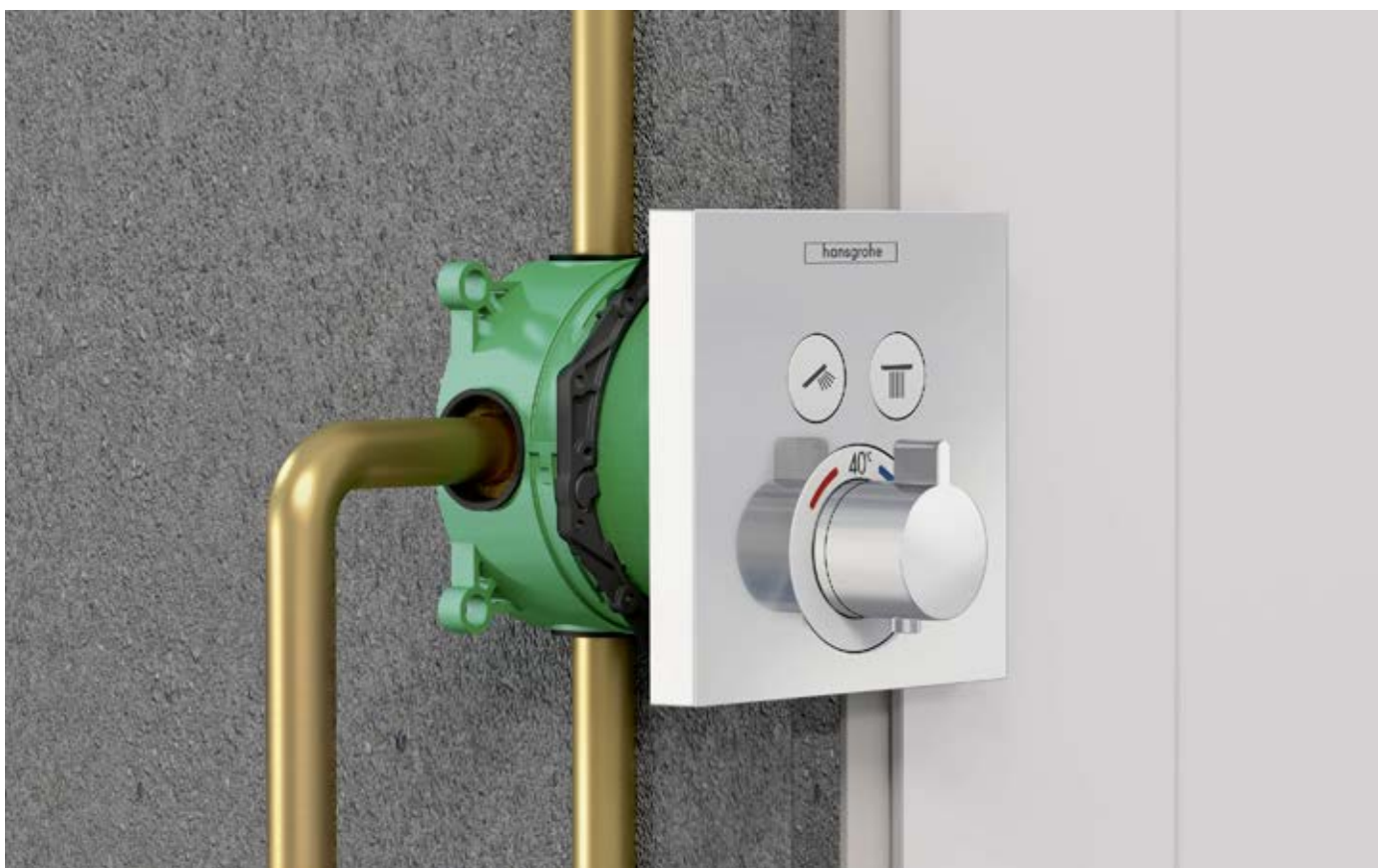

Concealed installation: The basic set disappears completely into the wall. Mixers and shower finish sets from various ranges can be fitted to it.

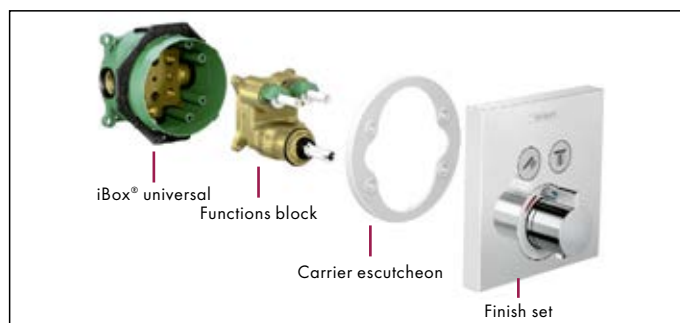

Over the long term: The basic set is retained when the bathroom is refurbished. The functions block and finish set can then be easily replaced.



iBox® universal: one for all

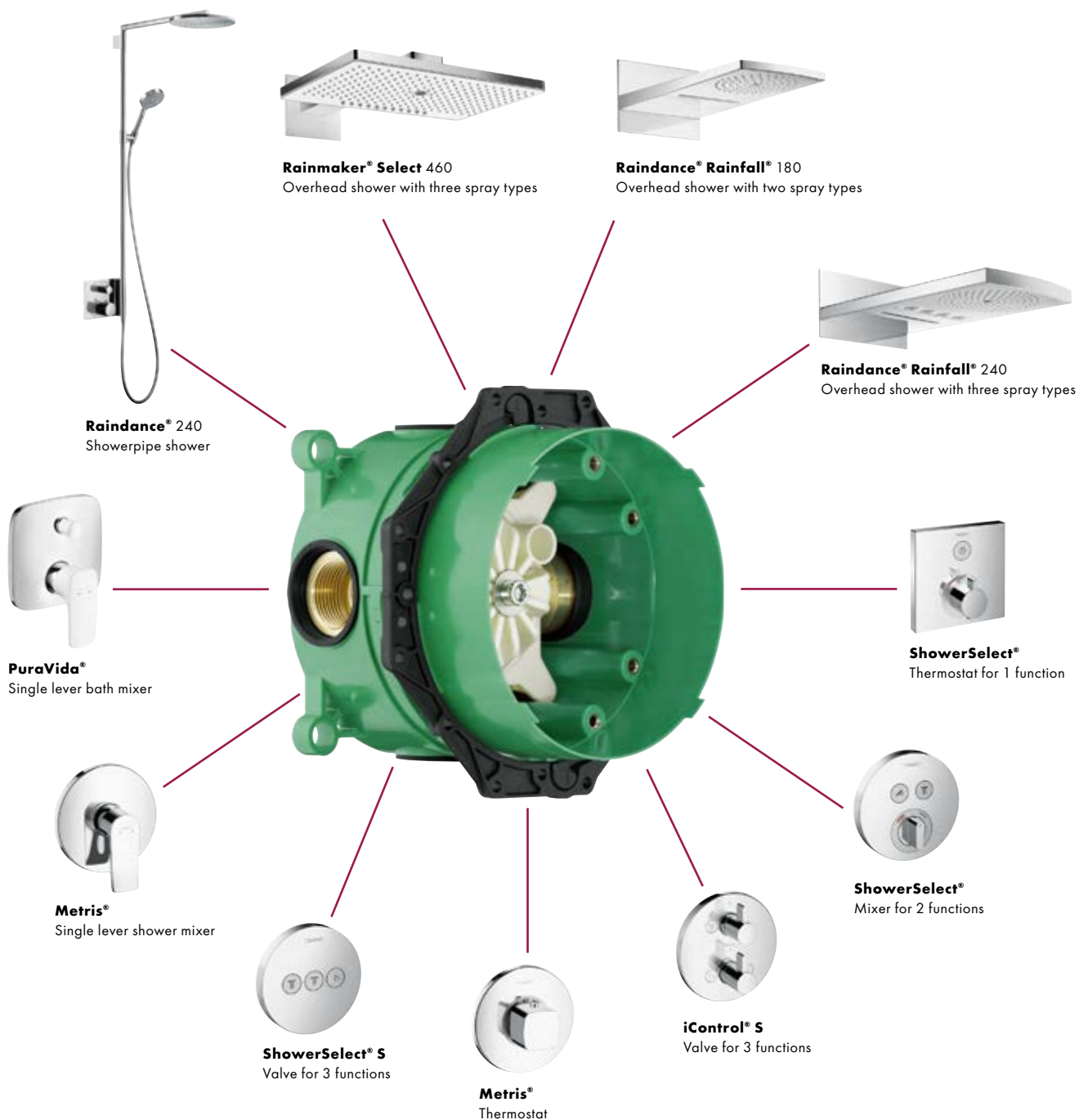

iBox® universal: convincing on all fronts

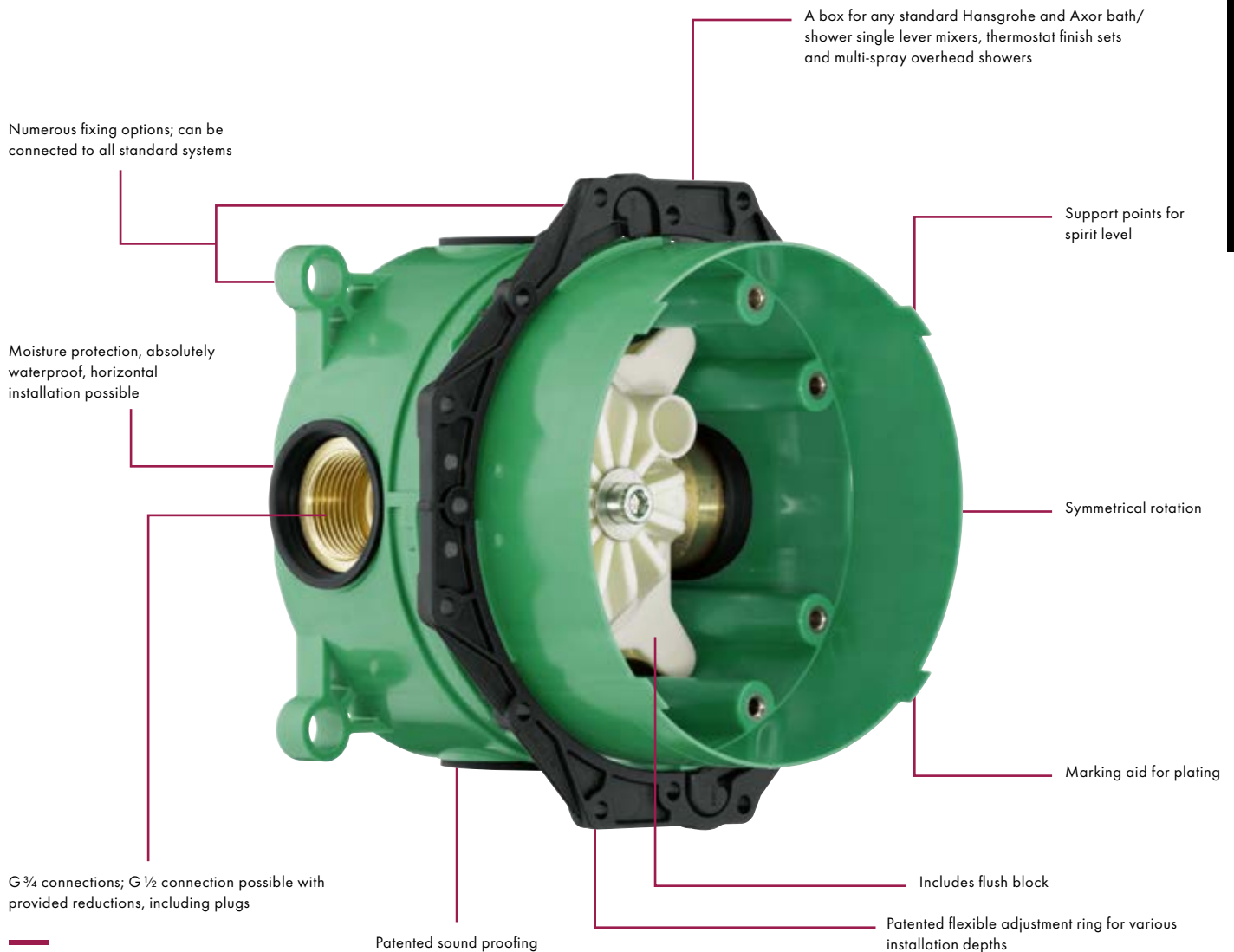

Advantages and benefits

- One basic set for 16 function solutions
- Suitable for over 200 Hansgrohe and Axor finish sets
- Pre-installation enhances decision making flexibility for mixers
- An attractive bathroom, as bulky technology is out of sight behind the wall
- Greater freedom of movement when showering
- Easy to replace with new mixers or finish set designs when renovating
- Concealed installation solutions tried and tested millions of times

Advantages and benefits specifically for project activities

- The iBox universal offers a high level of flexibility and lots of design options
- One basic set for all solutions, simplifying project planning
- The iBox is suitable for use in private or public facilities and complies with all the main international standards
- Covers any solution with up to 4 functions

iBox® universal: the all-rounder with many strengths

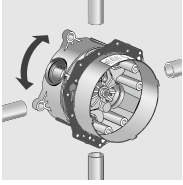

Rotation-symmetrical installation

- Symmetrical construction; all the connections are the same
- It is important that cold water is connected on the right and hot water on the left
- The lower outlet has priority for bath mixers
- Either the upper or lower outlet can be connected for shower mixers

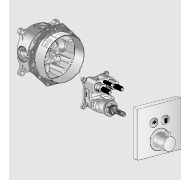

Safe and economical

- Basic set includes only the connection block
- The valuable functions block is supplied later and mounted with the finish set
- Prevents problems like theft, dirt and frost damage occurring during the building phase and expensive warehousing becomes unnecessary

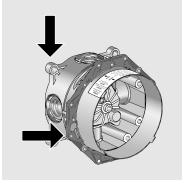

Many installation types

- Coordinated with to all the standard installation systems, connection types and mixers
- Patented flexible adjustment ring
- Attachment options on 2 levels and G^{3/4} connections for universal installation possibilities
- Also suitable for stronger wall constructions and dry wall installations as well as for pre-fabricated houses

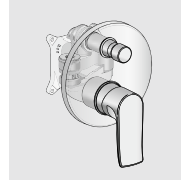

Integrated safety combination

- Used in conjunction with Exafill baths with an outflow and overflow mixer, it eliminates the need for an external pipe breaker on concealed installation single lever bath mixers: lower installation costs and fewer functional parts in the wall

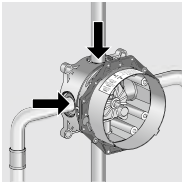

Perfect moisture protection

- Sealing sleeves on all 4 connections, sealing sleeve under the tiles and the carrier escutcheon that seals against splashes perfectly protect the masonry against moisture on all sides

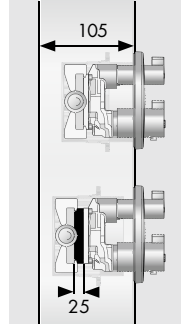

Solutions for walls that are very deep or very shallow

- If the iBox universal is too deep in the wall, the basic set extension is inserted between the connection and functions block
- The extension set provides safety right up to the wall and perfectly protects the masonry against moisture
- The standard body of the iBox universal has become flatter and is therefore even more suitable for walls with shallow installation depths

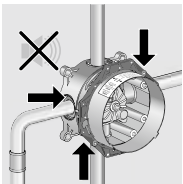

Low noise levels

- Brass bodies on seals ensure that the noise of water-bearing parts is transferred to the masonry
- The carrier escutcheon is screwed to the housing of the iBox universal and not to the functions block, which means that the noise cannot be transmitted to the tiles

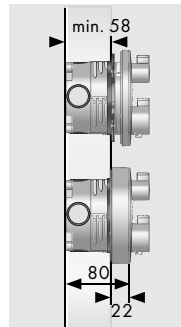

Collar extension

- Thanks to the extension, even shallow installation depths are no longer a problem
- The extension collar means that the iBox can be installed even in narrow walls

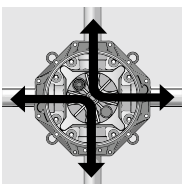

Easy rinsing

- Flush block included and can be mounted in various different positions. This means that pipes can be flushed through to the end just in front of the wall, as per DIN 1988/EN 1717 part 2

Attachment options

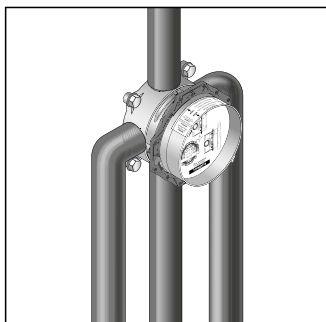

Installation directly on the wall

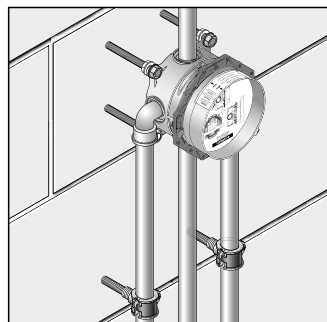
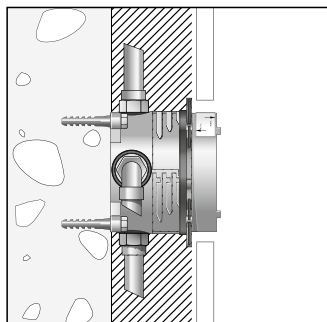

Installation in front of the wall; here with variable spacers on hanger bolts M 10

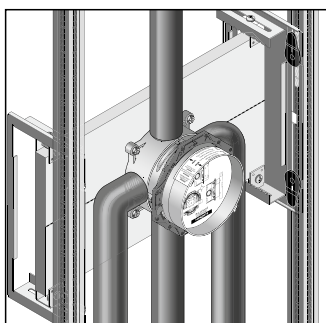
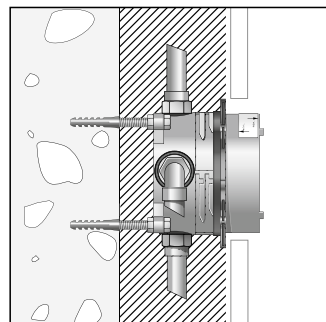

Installation on carrier system

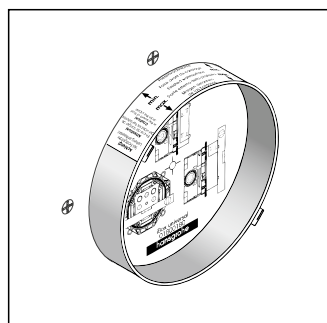
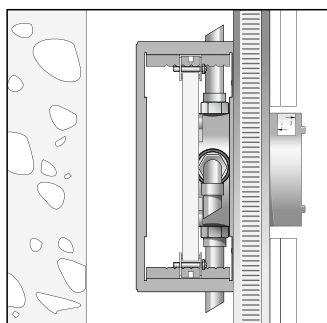

Installation on prefab house mounting panels or prefab shell

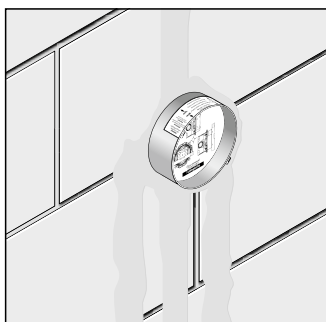
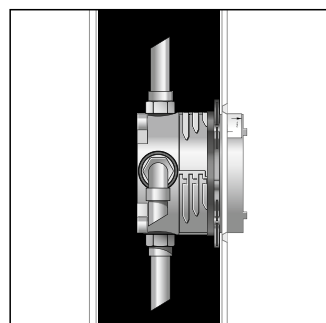

Installation directly in the wall

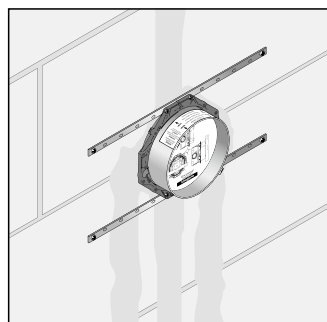
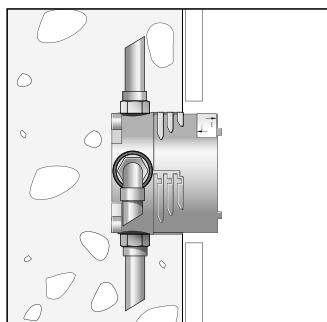

Installation with mounting rail set

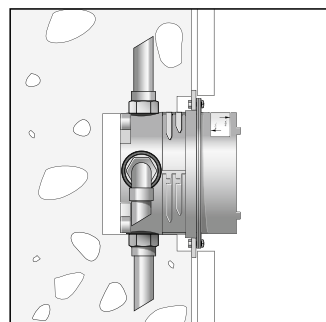

Shower control RainBrain®

The most intelligent way to enjoy comfort

The RainBrain is an electronic control shower. Whether changing spray types, setting temperatures, selecting the shower music, the RainBrain controls all eventualities with the greatest of ease.

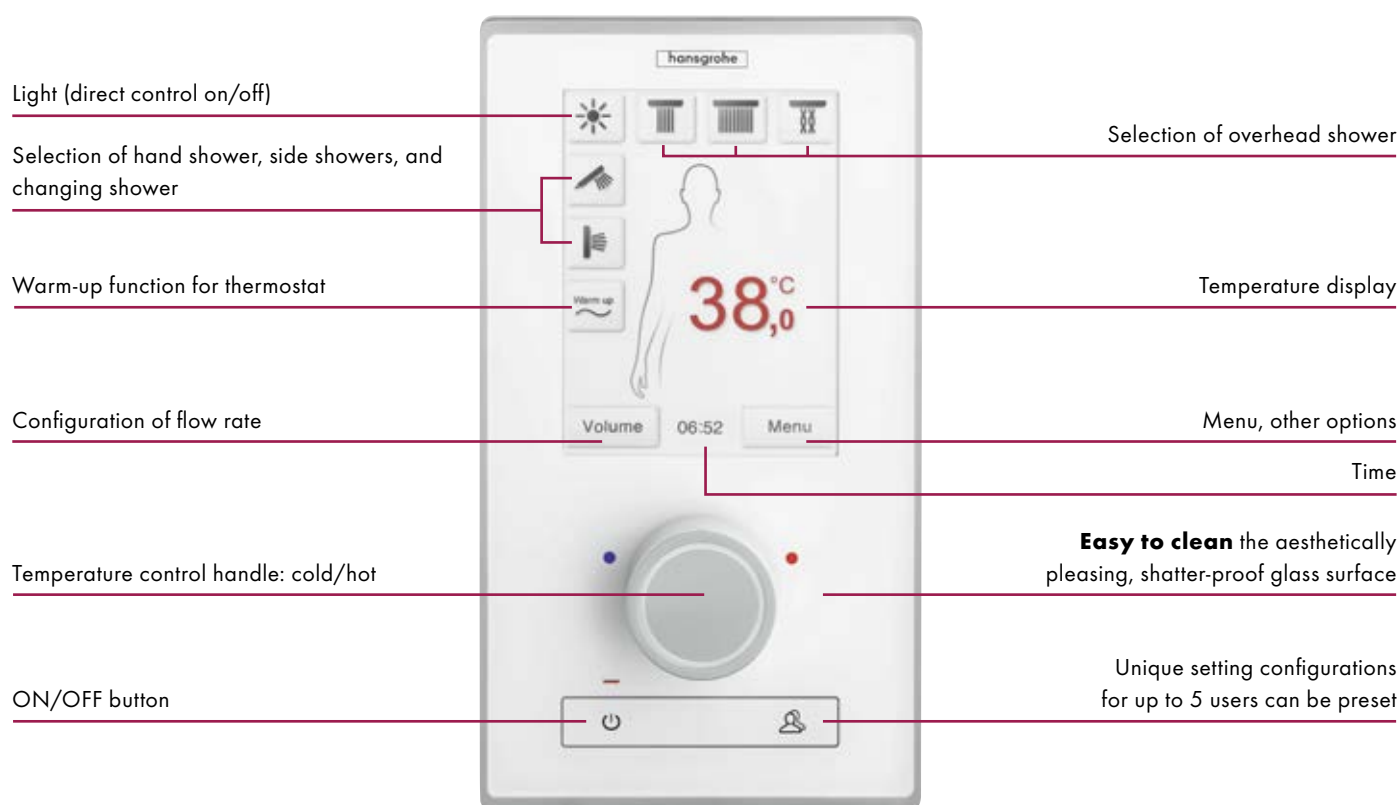

RainBrain® finish set
Electronic shower control for regulating the flow rate
15842, -000, -400

Installation details

The RainBrain shower control consists of 4 components, conveniently split into basic and finish set. The basic set contains the connecting bridge for receiving the functions box and an installation case for the operating panel. The finish set contains the functions box and the operating panel.



Advantages and benefits

- Technology and design highlight in the bathroom
- Unique touchscreen technology, intuitive use based on self-explanatory symbols
- Easy fingertip control of functions, spray types, light and music
- Individual programmable settings for up to five users
- Contemporary design
- Ease of planning and installation

Find out more at <http://pro.hansgrohe-int.com/rainbrain>

Installation situation



The electronic shower control Hansgrohe RainBrain consists of a total of four individual components that are divided into basic and finish sets.

Basic set:

- (3) Connecting bridge for the functions box
- (5) Installation case for the operating panel

Finish set:

- (4) Functions box
- (6) Operating panel

The practical division of the components for shell and finished installation guarantees safe, easy installation. It is also easy to calculate the required time

- (1) Hot and cold water supply
- (2) Feed pipes showers
- (3) Hansgrohe RainBrain connecting bridge
- (4) Hansgrohe RainBrain functions box
- (5) Hansgrohe RainBrain installation case operating panel
- (6) Hansgrohe RainBrain control panel
- (7) Hansgrohe Raindance Rainfall
- (8) Hansgrohe Fixfit hose connection
- (9) Hansgrohe Raindance Air 100 side showers
- (10) Hansgrohe Raindrain XXL outlet
- (11) Audio amplifier
- (12) Lighting control set
- (13) Distributor box for operating voltage
- (14) Loudspeaker
- (15) Lighting

Installation 1 function

ShowerSelect® thermostat concealed with Raindance® Select S 120 3jet hand shower

Components

Mixers

- (B) Basic set iBox universal
01800180
Thermostat ShowerSelect
for 1 function
15762, -000

Alternative:

- Thermostat ShowerSelect S
15744000
- Mixer ShowerSelect
15767000
- Mixer ShowerSelect S
15747000
- Thermostat Ecostat E
15707000
- Thermostat Ecostat S
15757000

Showers

- (A) Hand shower Raindance
Select S 120 3jet
26530, -000
Porter 'S shower holder
28331, -000
Isiflex shower hose
28276, -000
- (C) Shower connection Fixfit Square
26455, -000
- (D) Staro 90 waste system
60056, -000

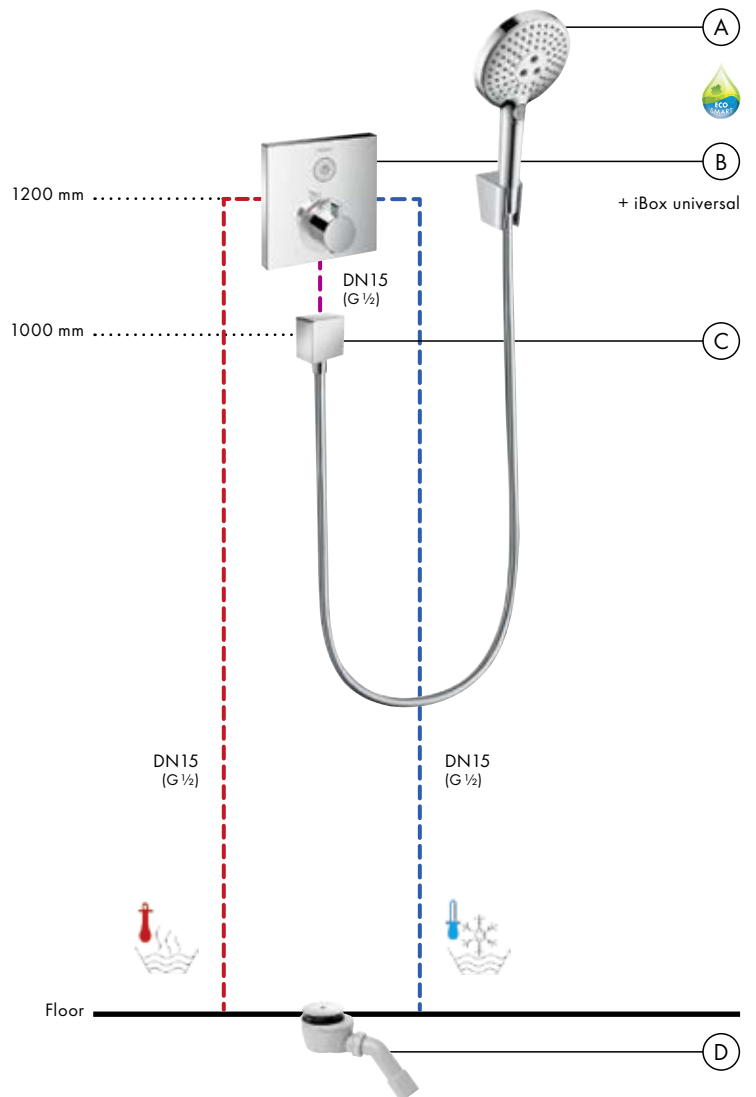
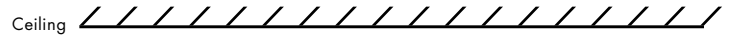

Flow diagram

Hand shower Raindance Select S 120 3jet
26530, -000

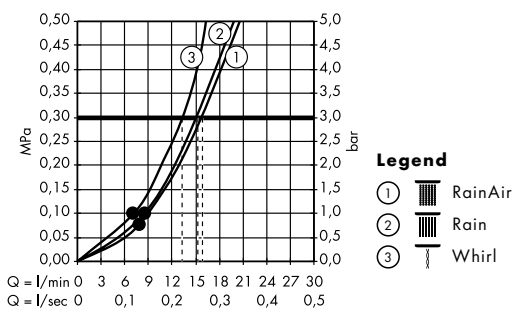

• denotes minimum operating pressure

Installation 2 functions

ShowerSelect® thermostat concealed with Raindance® Select S 300 2jet overhead shower and Raindance® Select S 120 3jet hand shower

Components

Mixers

- Ⓑ Basic set iBox universal
01800180
Thermostat ShowerSelect
for 2 functions
15763, -000

Alternative:
Thermostat ShowerSelect S
15743, -000
Mixer ShowerSelect
15768, -000
Mixer ShowerSelect S
15748, -000
Thermostat Ecostat E
15708, -000
Thermostat Ecostat S
15758, -000

Showers

- Ⓐ Overhead shower Raindance
Select S 300 2jet
27378, -000
- Ⓒ Hand shower Raindance
Select S 120 3jet
26530, -000
Porter 'S shower holder
28331, -000
Isiflex shower hose
28276, -000
- Ⓓ Shower connection Fixfit Square
26455, -000
- Ⓔ Staro 90 waste system
60056, -000

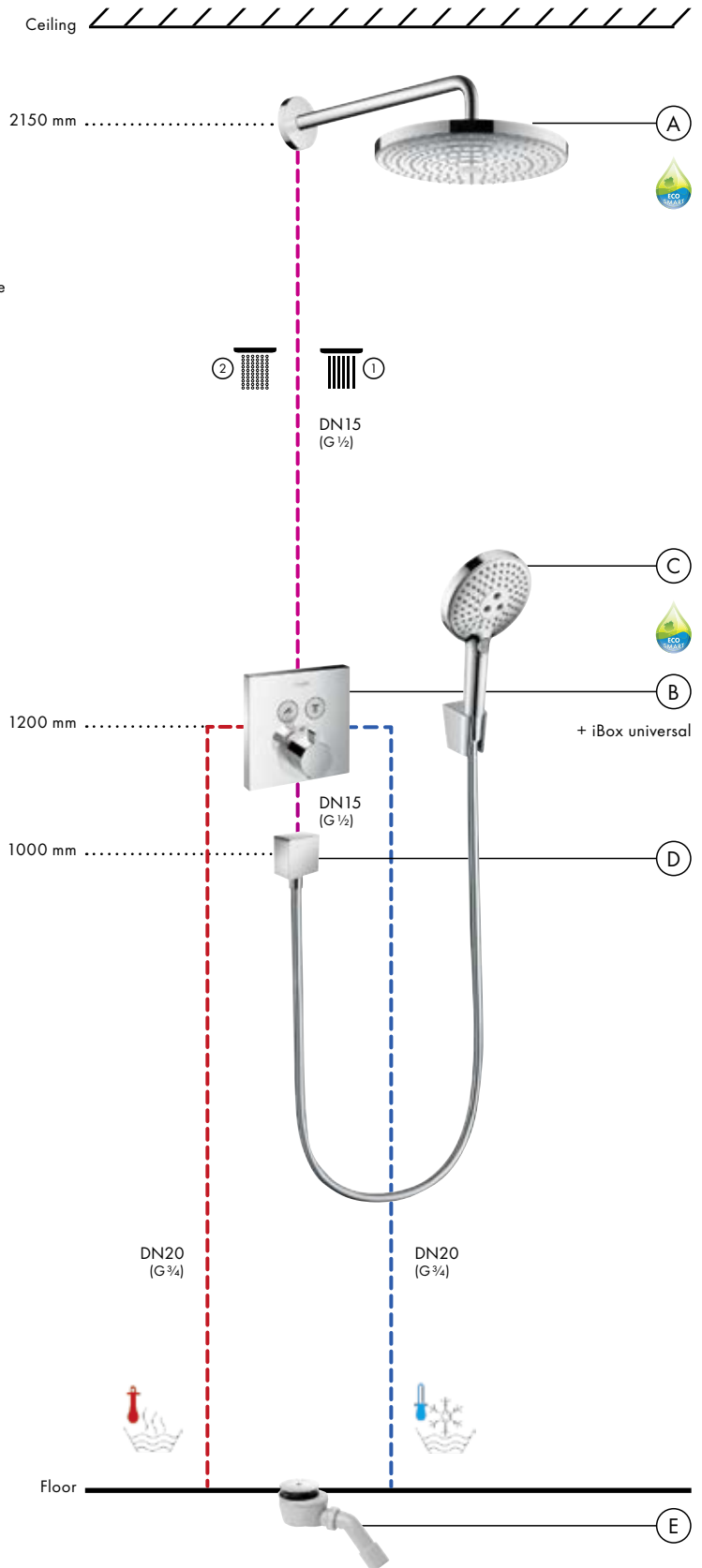

Flow diagram

Overhead shower Raindance Select S 300 2jet
27378, -000

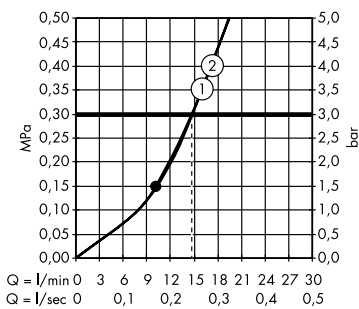

Legend

- Ⓛ Rain
- Ⓜ RainAir

Flow diagram

Hand shower Raindance Select S 120 3jet
26530, -000

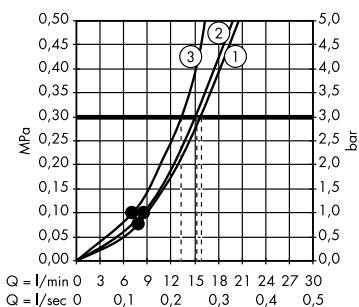

Legend

- Ⓛ RainAir
- Ⓜ Rain
- Ⓨ Whirl

• denotes minimum operating pressure

Installation 3 functions

ShowerSelect® thermostat concealed with 2 spray overhead shower Raindance® Rainfall® 2jet and Raindance® Select S 120 3jet hand shower

Components

Mixers

- (C) Basic set iBox universal
01800180
Valve ShowerSelect for 3 functions
15764, -000
- (D) Basic set iBox universal
01800180
Highflow Thermostat ShowerSelect
15760, -000

Alternative:
Valve ShowerSelect S
for 3 functions
15745, -000
Highflow Thermostat
ShowerSelect S
15741, -000

Showers

- (A) Basic set iBox universal
01800180
Overhead shower Raindance
Rainfall 2jet
28433, -000

Alternative:
Overhead shower Raindance
E 420 Air 2jet
27373, -000

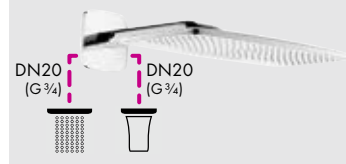

- (B) Hand shower Raindance
Select S 120 3jet
26530, -000
Porter 'S shower holder
28331, -000
Isiflex shower hose
28276, -000
- (E) Shower connection Fixfit Square
26455, -000
- (F) Raindrain XXL waste system
60067, -000

Flow diagram

Overhead shower Raindance Rainfall 2jet
28433, -000

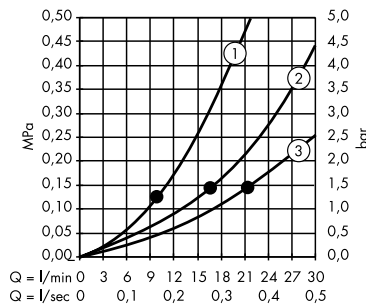

Flow diagram

Hand shower Raindance Select S 120 3jet
26530, -000

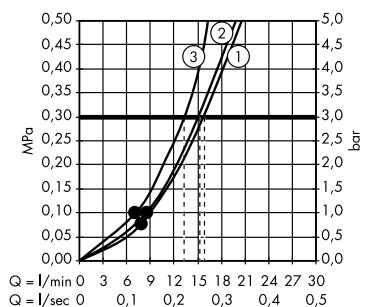

• denotes minimum operating pressure

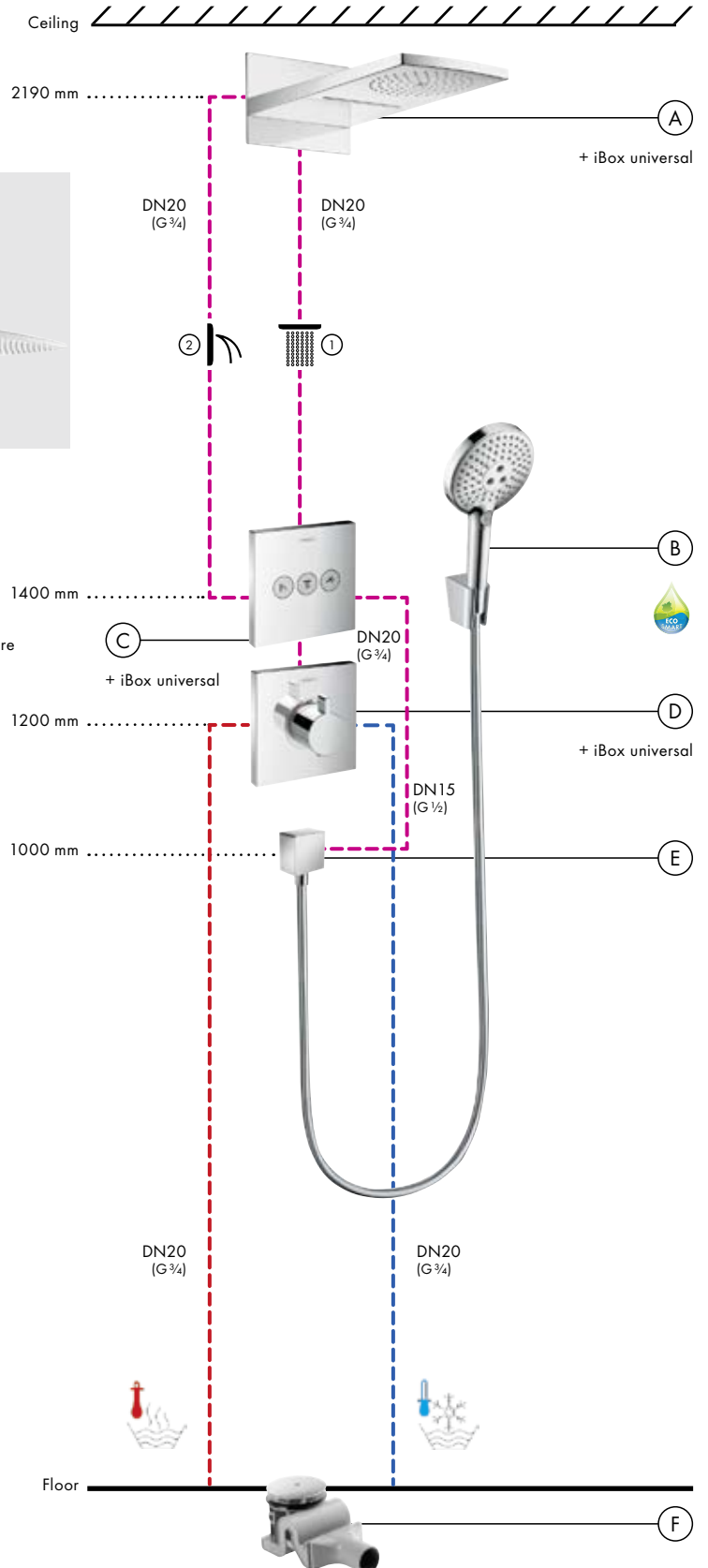

Installation 3 functions

Ecostat® S thermostat concealed with 2 spray overhead shower Raindance® Rainfall® 2jet and Raindance® Select S 120 3jet hand shower

Components

Mixers

- (C) Trio/Quattro basic set
15981180
Trio/Quattro S shut-off valve
15932, -000
- (D) Basic set iBox universal
01800180
Highflow Thermostat Ecostat S
15715, -000
- (E) Shut-off valve basic set
15974180
Shut-off valve S DN15/DN20
15972, -000

Other alternatives possible.

Showers

- (A) Basic set iBox universal
01800180
Overhead shower Raindance
Rainfall 2jet
28433, -000

Alternative:
Overhead shower Raindance
Select E 300 3jet
26468, -000

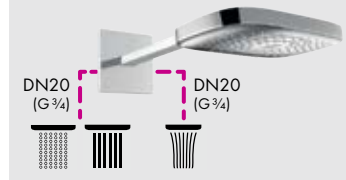

- (B) Hand shower Raindance
Select S 120 3jet
26530, -000
Porter 'S shower holder
28331, -000
Isiflex shower hose
28276, -000
- (F) Shower connection Fixfit S
27453, -000
- (G) Raindrain XXL waste system
60067, -000

Flow diagram

Overhead shower Raindance Rainfall 2jet
28433, -000

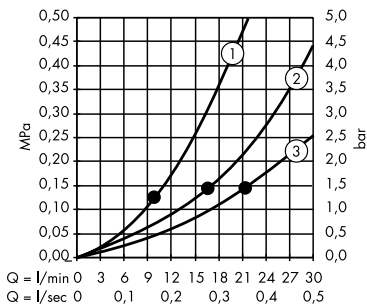

Flow diagram

Hand shower Raindance Select S 120 3jet
26530, -000

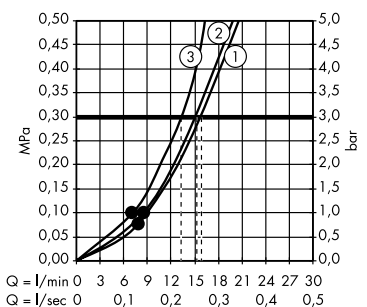

• denotes minimum operating pressure

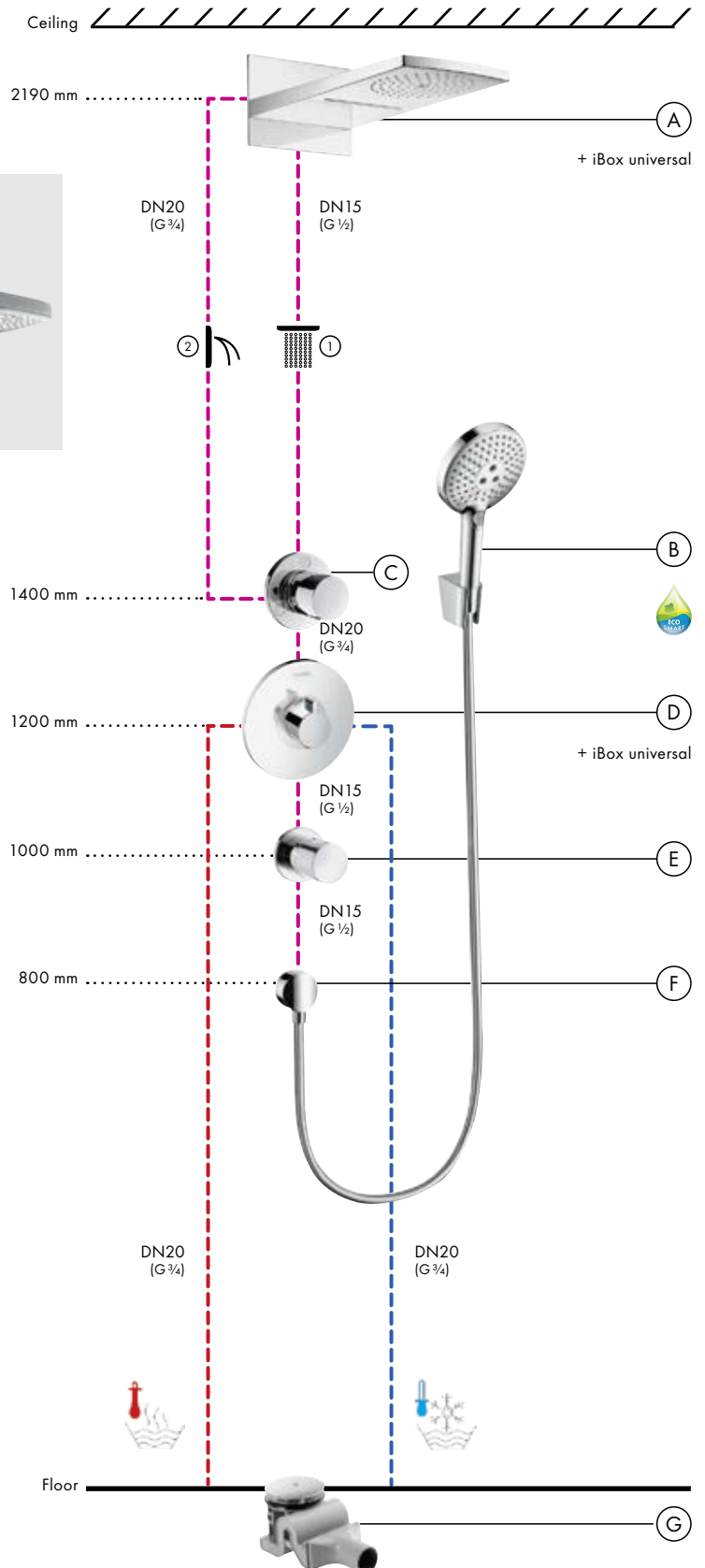

Installation 4 functions

ShowerSelect® thermostat concealed with 3 spray overhead shower Raindance® Rainfall® 3jet and Raindance® Select S 120 3jet hand shower

Components

Mixers

- (C) Basic set iBox universal #01800180
Valve ShowerSelect for 3 functions #15764, -000
- (D) Basic set iBox universal #01800180
Highflow Thermostat ShowerSelect #15760, -000

Alternative:
Valve ShowerSelect S for 3 functions #15745, -000
Highflow Thermostat ShowerSelect S #15742, -000

Showers

- (A) Basic set iBox universal #01800180
Overhead shower Raindance Rainfall 240 3jet #28411, -000
- (B) Hand shower Raindance Select S 120 3jet #26530, -000
Porter 'S' shower holder #28331, -000
Isiflex shower hose #28276, -000
- (E) Shower connection Fixfit Square #26455, -000
- (F) Raindrain XXL waste system #60067, -000

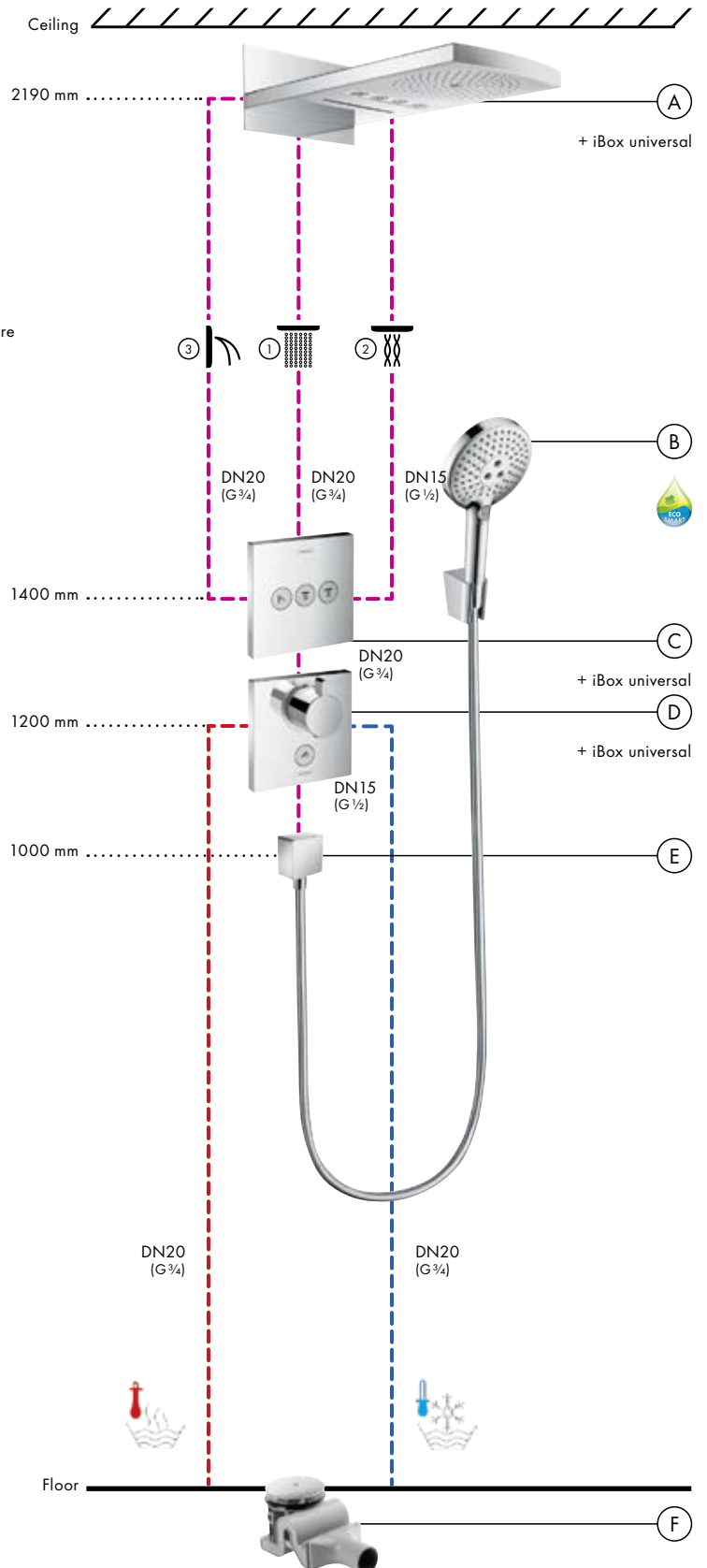

Flow diagram

Overhead shower Raindance Rainfall 3jet #28411, -000

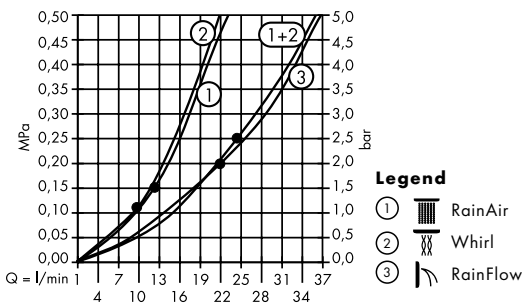

Flow diagram

Hand shower Raindance Select S 120 3jet #26530, -000

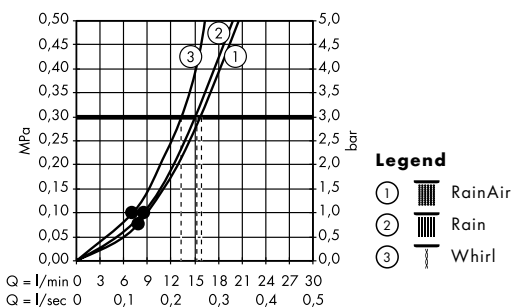

• denotes minimum operating pressure

Installation 4 functions

Ecostat® S thermostat concealed with 3 spray overhead shower Raindance® Rainfall® 3jet and Raindance® Select S 120 3jet hand shower

Components

Mixers

- (C) Quattro basic set
15930180
Trio/Quattro S shut-off valve
15932, -000
- (D) Shut-off valve basic set
15970180
Shut-off valve S DN15/DN20
15972, -000
- (E) Basic set iBox universal
01800180
Highflow Thermostat Ecostat S
15715, -000
- (F) Shut-off valve basic set
15974180
Shut-off valve S DN15/DN20
15972, -000

Other alternatives possible.

Showers

- (A) Basic set iBox universal
01800180
Overhead shower Raindance
Rainfall 240 3jet
28411, -000
- (B) Hand shower Raindance
Select S 120 3jet
26530, -000
Porter 'S shower holder
28331, -000
Isiflex shower hose
28276, -000
- (G) Shower connection Fixfit S
27453, -000
- (H) Raindrain XXL waste system
60067, -000

Flow diagram

Overhead shower Raindance Rainfall 3jet
28411, -000

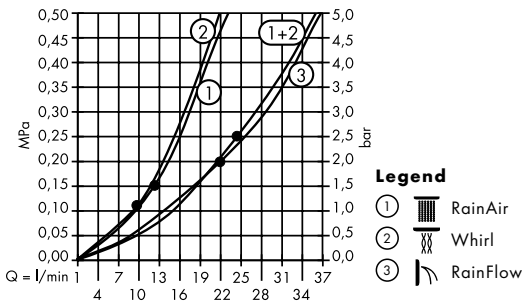

Flow diagram

Hand shower Raindance Select S 120 3jet
26530, -000

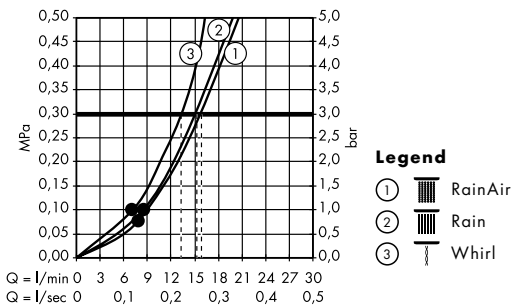

• denotes minimum operating pressure

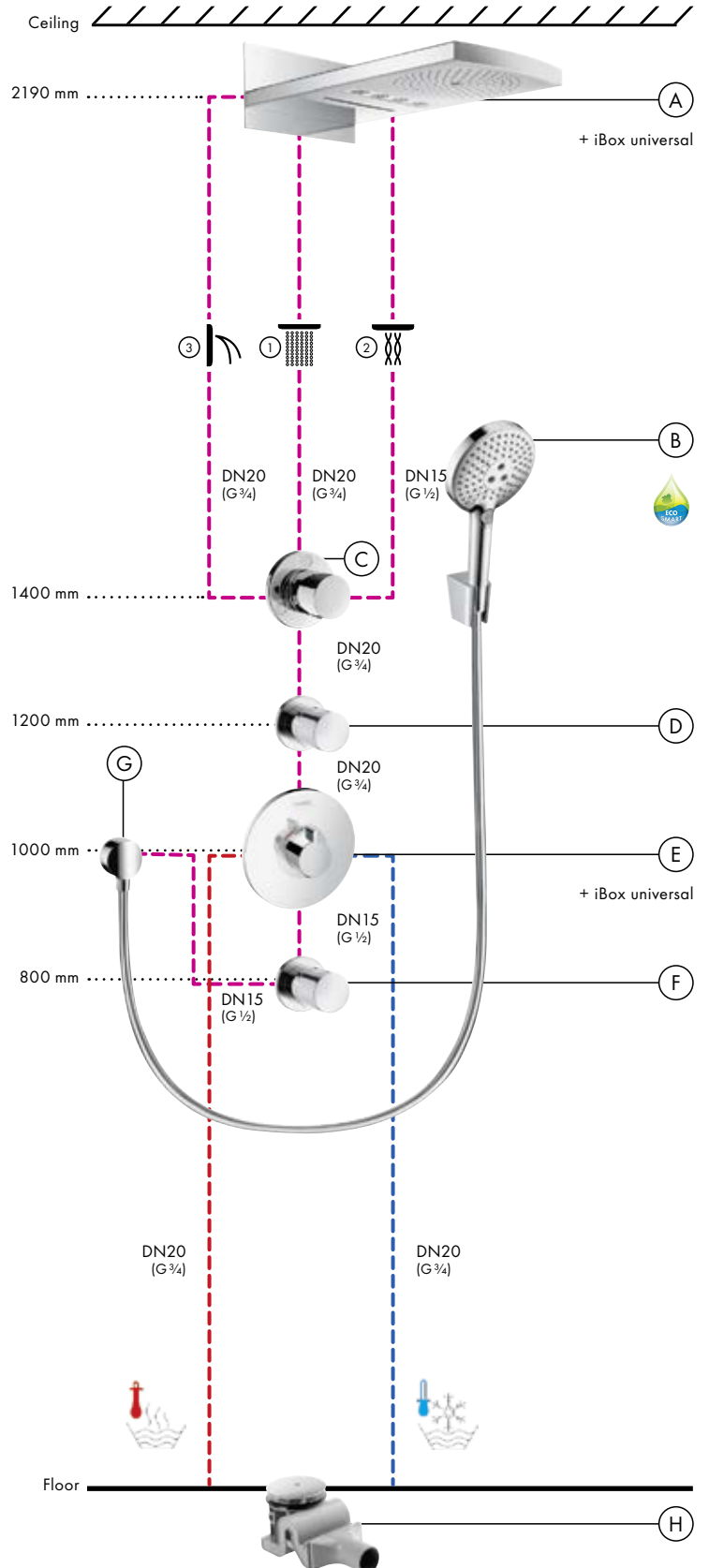

BATH MIXERS

The right product for every taste:

Basin mixers | Bidet mixers

Bath and shower mixers | Accessories



Hansgrohe bathroom mixers

Stylish choices for an individual dream bathroom

The Hansgrohe mixers line caters to every style and taste, from modern to classic, from geometrical to rounded. This wide range

gives your customers the freedom to find their personal style through the whole bathroom. Besides the wash basin solutions, there are also

matching bath and shower mixers and accessories.

PuraVida®



Elegant mixers for more sensuality in the bathroom. From page 140.

Metris®/Metris® S



Large areas add a timeless elegance to the bathroom. From page 146.

Talis® Select S/Talis® S

NEW

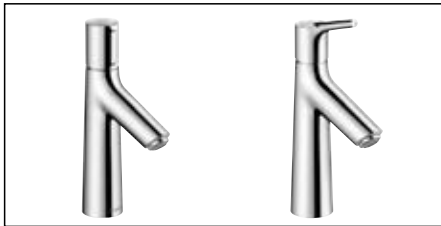

A new naturalness that also appeals for operation at the touch of a button. From page 152.

Talis®/Talis® S



Flowing forms create a modern flair. From page 156.

Talis® Select E/Talis® E

NEW



Pioneering style that also sets standards with operation at the touch of a button. From page 158.

Focus®



Dynamic design emanates freshness and lightness. From page 162.

Logis®

NEW



Soft silhouette for a homelike atmosphere. From page 164.

Metris® Classic



Decorative lines for an elevated ambience. From page 168.

Talis® Classic



Harmonious elegance for tasteful bathrooms. From page 170.

Logis® Classic

NEW



Classic charisma that elegantly completes the bathroom. From page 172.

ComfortZone: Mixer wash basin combinations



Something to suit every customer

Whether free standing, wall-hanging, surface-mounted or built-in basins, the perfected Hansgrohe portfolio with a range of heights provides the right solution for every one of your needs. High risers and high, swivelling mixers can be used to fill even large wash bowls or wash hair with ease. Mid range mixer heights allow adequate freedom of movement

for daily routines. Low mixers are a must, too, e.g. as highlights in the guest toilet or cloakroom. Optimal functionality is not the only consideration, the look is also decisive in the choice of mixer and washbasin combinations. To compare these to the best possible effect, you can make use of the Hansgrohe ComfortZone configurator available on the

internet. You can then design the washbasin with the greatest of ease. You can even show your customers in advance how each of the mixer lines blend perfectly into their environment. Visit www.hansgrohe-int.com/configurator

Avantgarde PuraVida®

Free standing basin



Example design with **PuraVida® 240**

Wall-hanging basin



Example design with **PuraVida® 200**

Modern

- Metris®/Metris® S
- Talis® Select S/Talis® S
- Talis®/Talis® S
- Talis® Select E/Talis® E
- Focus®
- Logis®



Example design with **Metris® 260**



Example design with **Metris® 230**

Classic

- Metris® Classic
- Talis® Classic
- Logis® Classic



Example design with **Metris® Classic 250**



ComfortZone: Whether you need more freedom of movement when washing your hands, washing your hair, or filling large containers; the taller the mixer, the more flexibility you have in your daily dealings with water. We call this area between the mixer and the basin the ComfortZone. For more comfort. For more space. For every day.



Talis® swivel spout:

This practical spout creates an arc shaped jet, boosting the personal ComfortZone in moments.

()

Surface-mounted basin

Built-in basin

Hand wash basin



Example design with **Metris® 200**



Example design with **Metris® 110**



Example design with **Metris® 100**



Example design with **Metris® Classic 100**



Example design with **Metris® Classic 100**



Example design with **Metris® Classic 100**

ComfortZone test



The right mixer for every washbasin

The taller the mixer, the larger the usable space. If a wash basin and mixer are not properly tuned to each other, the user suffers annoying splashes. As a measure to

eliminate this eventuality from the outset, Hansgrohe has developed the ComfortZone test. Under highly realistic conditions, Hansgrohe mixers are tested for their

compatibility with the wash basins of market leading manufacturers. The tests were conducted on the following five wash basin configurations.

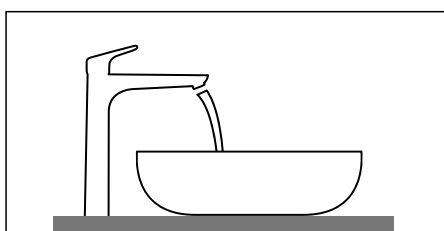

Mixer behind free standing surface-mounted basin or behind wash bowl.

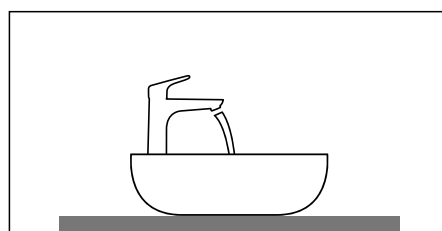

Wash bowl with surface-mounted mixer.

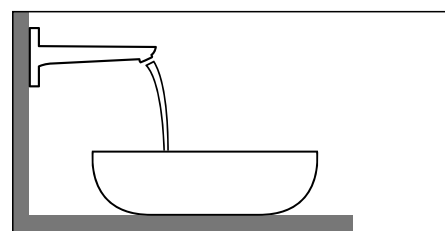

Wash bowl with wall mixer.

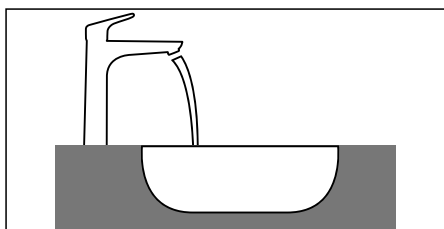

Mixer for built-in basin.

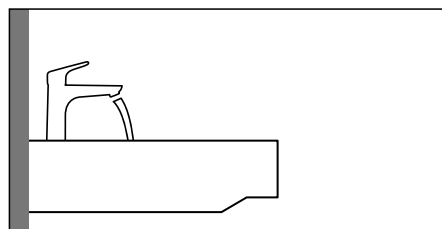

Wall-hanging wash basin with surface-mounted mixer.



Feel confident of your recommendation when you see: the Hansgrohe ComfortZone test seal.



How the ComfortZone test works

1. Free space test

Is there enough of a gap in the combination of mixer and wash basin? A test sphere is positioned between the mixer and wash basin to check how easy and comfortable it is to wash the hands.

2. Spray test

Is there any splashing when the mixer is turned on? The mixer is opened and closed several times under different water pressures. Between jets, the splashes are analysed and the wash basin rubbed dry.

3. Practical test

Is there any splashing when washing the hands? A standardised hand model is passed under the water jet and the splashes outside of the basin analysed.

Free PDF: the results from over 9000 combinations

Utilise our knowhow from thousands of tests: We provide you, as a professional partner, exclusive access to all findings of these test series. This overview of all tested mixer and wash basin combinations provides a sound

basis for your recommendations. The PDF files with all the test findings are available free of charge at <http://pro.hansgrohe-int.com/comfortzone-test>

hansgrohe

Which Hansgrohe mixer suits which basin?

Hansgrohe ComfortZone mixer with product code

Wash basin with product code

	450	500 x 250	485 x 315	395 x 465	550 x 465	850 x 490	1050 x 490	1250 x 490	600 x 470	800 x 470	1000 x 470	1200 x 470	500 x 380	600 x 380									
Metris	# 070215.00	# 070350.28	# 070350.29	# 070350.30	# 033048.00	# 033048.22	# 040750.00	# 031555.00	# 032985.00	# 032910.00	# 032912.00	# 045460.30	# 045460.37	# 045460.41	# 045480.00	# 045480.27	# 045410.27	# 045410.28	# 045412.00	# 045412.40	# 045350.00	# 045350.00	
Metris 100	# 31088000	✓	✓	✓																			
	# 31166000	✓	✓	✓																			
Metris 110	# 31080000	✓	✓	✓	✓ b1	✓	✓	✓	✓	✓	✓	✓	✓	✓	✓	✓	✓	✓	✓	✓	✓	✓	✓
	# 31121000	✓	✓	✓	✓ b1	✓	✓	✓	✓	✓	✓	✓	✓	✓	✓	✓	✓	✓	✓	✓	✓	✓	✓
	# 31084000	✓	✓	✓	✓ b1	✓	✓	✓	✓	✓	✓	✓	✓	✓	✓	✓	✓	✓	✓	✓	✓	✓	✓
Metris 200	# 31183000			✓ b1	✓	✓	✓	✓	✓	✓	✓	✓	✓	✓	✓	✓	✓	✓	✓	✓	✓	✓	✓
	# 31185000			✓ b1	✓	✓	✓	✓	✓	✓	✓	✓	✓	✓	✓	✓	✓	✓	✓	✓	✓	✓	✓
Metris 200	# 31087000			✓ b1	✓	✓	✓	✓	✓	✓	✓	✓	✓	✓	✓	✓	✓	✓	✓	✓	✓	✓	✓
	# 31187000			✓ b1	✓	✓	✓	✓	✓	✓	✓	✓	✓	✓	✓	✓	✓	✓	✓	✓	✓	✓	✓
	# 31081000			✓ b1	✓	✓	✓	✓	✓	✓	✓	✓	✓	✓	✓	✓	✓	✓	✓	✓	✓	✓	✓
Metris 200	# 31082000			✓ b2	✓	✓	✓	✓	✓	✓	✓	✓	✓	✓	✓	✓	✓	✓	✓	✓	✓	✓	✓
	# 31184000			✓ b2	✓	✓	✓	✓	✓	✓	✓	✓	✓	✓	✓	✓	✓	✓	✓	✓	✓	✓	✓
Metris 165 mm	# 31085000			✓ d1	✓	✓	✓	✓	✓	✓	✓	✓	✓	✓	✓	✓	✓	✓	✓	✓	✓	✓	✓
Metris 225 mm	# 31086000			✓ d1	✓	✓	✓	✓	✓	✓	✓	✓	✓	✓	✓	✓	✓	✓	✓	✓	✓	✓	✓

Suitable combinations

Mounting dimensions for different installations



Advantages and benefits

- Reliable test procedure on the wash basins of leading manufacturers, fitted in accordance with the instructions
 - Recommendations from over 9000 tested mixer wash basin combinations available online for planning – constantly expanded and updated
- The certainty that wash basin and mixer harmonise – without annoying splashes

Find out more in the “ComfortZone Test” discussion and at <http://pro.hansgrohe-int.com/comfortzone-test>

Innovative mixer technologies by Hansgrohe

More technology and comfort for you and your customers



Advantages and benefits

- EcoSmart technology limits flow to 5 l/min, saving water and energy
- QuickClean for easy cleaning and long-lasting mixers
- AirPower for a full and soft water jet
- Compliance with the German drinking water regulations TrinkwV of 2013
- Various designs and styles - the right mixer for every taste
- Five year warranty

Find out more at <http://pro.hansgrohe-int.com>



Select: easy operation at the touch of a button

A button instead of a lever – this is the new shape of comfort at the basin. Thanks to the Select button, a gentle touch is all it takes to get the water flowing. Another touch, and it

stops. This makes daily routines such as shaving, washing hair and brushing teeth much easier. For people of any age. The mechanical Select button satisfies any requirements: long-

term tests have confirmed its quality and durability.



Advantages and benefits

- Easy operation – suitable for all ages
- Temperature can be pre-set
- Can also be operated with an arm or elbow

AirPower: for water in all of its fullness

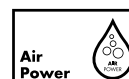

AirPower draws air in through the outlet and then it is used to enrich the flowing water. The water jet becomes fuller, lighter and softer.



Advantages and benefits

- Fuller, lighter, softer drops for a pleasant water jet
- Less risk of splashing
- High efficiency contributes towards reduced water consumption

QuickClean: rubbing away limescale in moments



QuickClean stands for flexible silicone inserts on the aerators that are simply rubbed with a finger to remove dirt and limescale. This ensures the products remain functional and last longer.



Advantages and benefits

- Fast and easy cleaning
- Long lifetime and functionality



EcoSmart: water and energy savings

Thanks to EcoSmart technology, the water consumed by all Hansgrohe basin mixers could be reduced to 5 l/min from the customary 13 l/min. This also saves energy because less

water needs to be heated. All this was made possible with air injection and the integrated EcoSmart system. This special efficiency was confirmed with the Bathroom Manufacturers

Association **Water Efficiency Label** Scheme. EcoSmart is not only about potential savings, but also the protection of our environment.



WELL Home Water Efficiency Label	
Manufacturer:	Hansgrohe SE
Product category:	Wash-basin valve
Type:	Single-lever valve
Model:	Hansgrohe Metris 110
Registration number:	WA1000320110209
Water Efficiency Criteria	
Flow rate > 6.0 l/min ≤ 9.0 l/min	*
Controlled flow rate ≥ 4.0 l/min ≤ 6.0 l/min	** ←
Flow-independent temperature setting	*
Temperature limit / Cold water valve	** ←
<small>Information about use and installation: www.well-online.eu A Label of EU-United Values European Valve Manufacturers Association</small>	

l/min
5.0

Example calculation of annual savings with EcoSmart basin mixer*:

Water approx 61,880 l
 CO₂ approx 413 kg
 Costs approx 549 € for water and energy

* Compared with a basin mixer with 13.5 l/min. Average values for a family of four in Germany in 2014.

All products with WELL certificates are specially marked in the catalogue



Advantages and benefits

- Water consumption as low as 5 l/min
- Precision O ring for a constant flow even under fluctuating water pressures
- Full, sparkling water jet thanks to air enrichment
- Reduced consumption for less energy needs and hence less CO₂ emissions
- Lower water and energy consumption for double efficiency
- WELL quality mark as certification basis in projects



How much water can be saved is calculated by the savings calculator at:
<http://pro.hansgrohe-int.com/savings-calculator>

l/min
3.5

LowFlow: mixers for minimal flow rates

Especially in projects, water and energy savings are an important factor for the certification of buildings, e.g. under Part G, LEED or BREEAM. For this purpose, Hansgrohe has developed special cartridges that minimise the flow rate through its mixers. These LowFlow cartridges have a restricted opening angle and special spray formers. Result: a flow rate of only 3.5 l/min.



Advantages and benefits

- Savings in water and energy
- Certification advantages especially for projects
- Precise temperature setting despite low flow rate

CoolStart: now saving energy is even easier

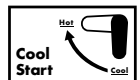

Whereas the central position on standard mixers immediately activates mixed water (both hot and cold), with CoolStart mixers only cold water runs through. The pipe system is therefore not filled unnecessarily with hot water. Hot water is not added until the lever is moved to the left. This helps to reduce the energy needs and hence CO₂ emissions as well. This goes easy on the environment – and your pocket as well.



CoolStart technology is available in the following mixers:



Metris® 110



Talis® 80
Talis® S 80
Talis® E 80



Focus® 100
Focus® 70



Logis® 100
Logis® 70

CoolStart: Hot water runs only when it is actually needed.





















Advantages and benefits

- At the basic setting, only cold water flows without the need to draw on heated water
- Potential for water, energy and financial savings
- Special user ergonomics (the lever need only be moved to the left for hot water)

Hansgrohe bathroom mixers

The bathroom mixer lines at a glance

























	PuraVida®	Metris®	Metris® S	Metris® Classic	NEW Talis® Select S/Talis® S
Spout height ↑	 PuraVida® 240	 Metris® 260	 Metris® S	 Metris® Classic 250	
		 Metris® 230	 Metris® S		 Talis® S 210
	 PuraVida® 200	 Metris® 200	 Metris® S NEW		 Talis® Select S 190
	 PuraVida® 110	 Metris® 110	 Metris® S		 Talis® Select S 100
	 PuraVida® 100	 Metris® 100		 Metris® Classic 100	 Talis® Select S 80
	More details on PuraVida bathroom mixers can be found on pages 140 onwards.	More details on Metris bathroom mixers can be found on pages 146 onwards.		More details on Metris Classic bathroom mixers can be found on pages 168 onwards.	More details on Talis bathroom mixers can be found on pages 152 onwards.

How to use the overview in your sales presentation























































The higher a product is positioned, the greater its ComfortZone. The products are arranged in ranges extending to the right.

Hansgrohe bathroom mixers

























The bathroom mixer range at a glance















































				NEW
		PuraVida®	Metris®	Talis® Select S
Basin				
	Pillar tap	 # 15132, -000, -400	 # 31166, -000	
Single lever basin mixer	for small wash basins	 # 15075, -000, -400	 # 31088, -000	
	with pop-up waste set	 # 15074, -000, -400	 # 31080, -000	 # 72040, -000
	with Push-Open waste	 # 15070, -000, -400		
	without waste set		 # 31084, -000	 # 72041, -000
	for open water heaters		 # 31074, -000	
Taller models	with pop-up waste set	 # 15081, -000, -400	 # 31183, -000	 # 72042, -000
	without waste set			 # 72043, -000
Single lever basin mixer with swivel spout	with pop-up waste set		 # 31087, -000	
	with Push-Open waste		 # 31187, -000	
	without waste set		 # 31081, -000	
Single lever basin mixers for wash bowls (high risers)	with pop-up waste set	 # 15072, -000, -400	 # 31082, -000	 # 72044, -000
	without waste set		 # 31184, -000	 # 72045, -000
3-hole basin mixer		 # 15073, -000, -400	 # 31083, -000	

This excerpt from the Hansgrohe product range is to help your customers find the right solution for each and every one of their requirements. The overview presents possible solutions within the Hansgrohe core range.

NEW Talis® S	NEW Talis® Select E	NEW Talis® E	Talis®	Focus®	Logis®
 #72017,-000		 #71706,-000	 #32130,-000	 #31130,-000	 #71120,-000
 #72010,-000		 #71700,-000	 #32040,-000	 #31730,-000	 #71070,-000
 #72011,-000		 #71701,-000		 #31604,-000	 #71077,-000
 #72012,-000		 #71702,-000	 #32041,-000	 #31733,-000	 #71071,-000
 #72016,-000		 #71707,-000		 #31132,-000	 #71074,-000
 #72020,-000	 #71750,-000	 #71710,-000	 #32052,-000	 #31607,-000	 #71100,-000
 #72021,-000	 #71751,-000	 #71712,-000		 #31517,-000	 #71101,-000
 #72105,-000			 #32084,-000	 #31609,-000	 #71130,-000
			 #32082,-000		
				 #31519,-000	 #71131,-000
 #72031,-000	 #71752,-000	 #71716,-000		 #31608,-000	 #71090,-000
 #72032,-000	 #71753,-000	 #71717,-000		 #31518,-000	 #71091,-000
 #72130,-000		 #71733,-000	 #32310,-000		 #71133,-000

NEW

		PuraVida®	Metris®	Talis® Select S
Basin				
Single lever basin mixer	Wall installation 165 mm	 # 15084, -000, -400	 # 31085, -000	
	Wall installation 225 mm	 # 15085, -000, -400	 # 31086, -000	
Electronic mixer				
		 # 15170, -000, -400	 # 31100, -000	
Bidet				
Single lever bidet mixer		 # 15270, -000, -400	 # 31280, -000	 # 72202, -000
Bath				
Single lever bath mixer	Exposed	 # 15472, -000, -400	 # 31480, -000	
	Concealed	 # 15445, -000, -400 # 15447, -000, -400	 # 31487, -000 # 31493, -000 # 31454, -000 # 31451, -000	
	Floor standing	 # 15473, -000, -400	 # 31471, -000	
3-hole rim-mounted mixer				
3-hole rim-mounted mixer		 # 15432, -000, -400	 # 31190, -000	
4-hole rim-mounted mixer		 # 15446, -000, -400	 # 31442, -000	
Bath filler		 # 15412, -000, -400	 # 31494, -000	
Shower				
Single lever shower mixer	Exposed	 # 15672, -000, -400	 # 31680, -000	
	Concealed	 # 15665, -000, -400	 # 31685, -000 # 31456, -000	

NEW Talis® S	NEW Talis® Select E	NEW Talis® E	Talis®	Focus®	Logis®
 # 72110, -000		 # 71732, -000	 # 31618, -000		 195 mm # 71220, -000
 # 72111, -000		 # 71134, -000	 # 31611, -000		
			 # 32110, -000	 # 31171, -000	
 # 72200, -000		 # 71720, -000	 # 32240, -000	 # 31920, -000	 # 71200, -000 # 71204, -000
 # 72400, -000		 # 71740, -000	 # 32440, -000	 # 31940, -000	 # 71400, -000
 # 72405, -000 # 72406, -000		 # 71745, -000 # 71474, -000	 # 32475, -000 # 32477, -000	 # 31945, -000 # 31946, -000	 # 71405, -000 # 71407, -000
 # 72412, -000					
 # 72415, -000		 # 71747, -000			
 # 72416, -000		 # 71730, -000			 # 71310, -000
 # 72418, -000		 # 71748, -000			
 # 72410, -000		 # 71410, -000	 # 13414, -000	 # 13414, -000	 # 71410, -000
 # 72600, -000		 # 71760, -000	 # 32640, -000	 # 31960, -000	 # 71600, -000
 # 72605, -000		 # 71765, -000	 # 32675, -000	 # 31965, -000	 # 71605, -000

NEW

Talis®/Talis® S



Talis® 250



Talis® 210 Talis® S



Talis® 150



Talis® 80 Talis® S

Talis® Select E/Talis® E



Talis® Select E 240 Talis® E 240



Talis® Select E 110 Talis® E 110



Talis® E 80

Talis® Classic



Talis® Classic 230



Talis® Classic 80 Talis® Classic Natural 90

More details on Talis Classic bathroom mixers can be found on pages 170 onwards.

Focus®



Focus® 240



Focus® 190



Focus® 100



Focus® 70

More details on Focus bathroom mixers can be found on pages 162 onwards.

Logis®



Logis® 210



Logis® 190



Logis® 100



Logis® 70

More details on Logis bathroom mixers can be found on pages 164 onwards.

PuraVida®

Sensuous poetry of purity and clarity



PuraVida® 110



Attractive: PuraVida emanates a special elegance and integrates perfectly in the bathroom, harmonising with white ceramics.



Complete in itself: Here pure elegance can be seen in all of the details. Moreover, the overhead shower is ergonomically shaped to completely cover the user's shoulders.



Emotionally appealing: The DualFinish surface unites white and chrome in a harmony of quality.



Advantages and benefits

- Breadth of range to enable complete, coordinated bathroom design
- Sculptured look from the harmonious unity of body and spout
- Flat pin handle with joystick cartridge
- Visible quality in the precise contoured lines
- Clear laminar jet and adjustable spray angle
- DualFinish surface with precise edges between chrome and white
- Scratch resistant powder coating

Basin/bidet



PuraVida® 240
Single lever basin mixer
with Push-Open waste
15072, -000, -400 Hose
length 900 mm
15066, -000, -400 Hose
length 600 mm



PuraVida® 200
Single lever basin mixer
with Push-Open waste
15081, -000, -400



PuraVida® 110
Single lever basin mixer
15070, -000, -400
with Push-Open waste
15074, -000, -400
with pop-up waste set



PuraVida® 100
Single lever basin mixer
for small wash basin
with Push-Open waste
15075, -000, -400



More freedom of movement at the wash basin for greater comfort



PuraVida® 100
Pillar top for small wash basin
15132, -000, -400



PuraVida®
Electronic basin mixer with
temperature control
15170, -000, -400 Battery
operation
15172, -000, -400 Mains
connection 230 V



PuraVida® 100
3-hole basin mixer with fixed
spout
15073, -000, -400 without
waste set
15063, -000, -400 with
pop-up waste set



PuraVida®
Single lever basin mixer for
wall installation
15085, -000, -400 225 mm
Basic set for concealed
installation
13622180



PuraVida®
Single lever basin mixer for
wall installation
15084, -000, -400 165 mm
Basic set for concealed
installation
13622180



PuraVida®
Single lever bidet mixer
with pop-up waste set
15270, -000, -400



Surface chrome
(-000)



Surface white/
chrome (-400)

All products are shown with white/chrome (-400) surfaces.

PuraVida®

Bath



PuraVida®
3-hole rim-mounted mixer
15432, -000, -400
Basic set for concealed installation
13437180



PuraVida®
4-hole bath mixer
for rim-mounted installation
15446, -000, -400
Basic set for concealed installation
13444180



PuraVida®
2-hole rim-mounted thermostat
15474, -000, -400
Basic set for concealed installation
13550180

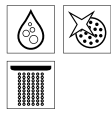
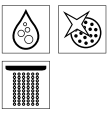

- No broken tiles thanks to pre-assembled basic set
- Secuflex Box protects the shower hose behind the bath
- Shower hose does not catch when used
- Easy servicing thanks to completely sealed system which can be accessed from above



PuraVida®
Single lever bath mixer,
floor standing, with PuraVida
120 ljet baton hand shower
15473, -000, -400
Basic set for concealed installation
10452180



PuraVida®
Single lever bath mixer
exposed
15472, -000, -400



PuraVida®
Single lever bath mixer
concealed
15445, -000, -400
15447, -000, -400 with
safety combination



PuraVida®
Bath filler
exposed
15412, -000, -400

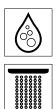

Shower



PuraVida®
Single lever shower mixer
exposed
15672, -000, -400



PuraVida®
Single lever shower mixer
concealed
15665, -000, -400



Surface chrome
(-000)



Surface white/
chrome (-400)



PuraVida®
Thermostat for 1 function
Concealed
15775, -000, -400



PuraVida®
Thermostat for 2 functions
Concealed
15771, -000, -400



PuraVida®
Thermostat
Concealed
15770, -000, -400
Highflow Thermostat
15772, -000, -400
(not shown)



PuraVida® iControl®
Valve for 3 functions
Concealed
15777, -000, -400



Trio®/Quattro®
Shut-off/diverter valve
for PuraVida
15937, -000, -400



Shut-off valve
for PuraVida
15978, -000, -400

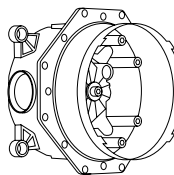

**Basic set for concealed
thermostats and mixers**
01800180 iBox universal



PuraVida®

Showers



PuraVida® 400
Overhead shower (21 l/min)
27437, -000, -400 with shower arm 390 mm
27390, -000, -400 with ceiling connection 100 mm
(not shown)



PuraVida® 150 3jet
Hand shower
28557, -000, -400 (16 l/min)
28567, -000, -400 (9 l/min) EcoSmart



PuraVida® 120 1jet
Baton hand shower
28558, -000, -400 (16 l/min)
28568, -000, -400 (9 l/min) EcoSmart



- Ergonomically shaped for the width of shoulders
- Long shower arm for generous freedom of movement
- DualFinish for elegant surfaces



- Innovative design
- 2-shell structure
- Spray modes changed at the push of a button
- Hygienic, internal water guide



PuraVida® 100
Side shower
28430, -000, -400

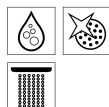

PuraVida®/Unica® Set
27853, -000, -400 0.90 m

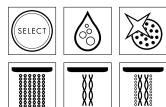

Accessories



Porter 'S
Shower holder
28331, -000



PuraVida® Fixfit®
DN15 hose connection with ball joint and non-return valve
27414, -000

Accessories



PuraVida®
Liquid soap dispenser
41503, -000



PuraVida®
Toothbrush tumbler
41504, -000



PuraVida®
Soap dish
41502, -000



PuraVida®
Towel hook
41501, -000



PuraVida®
Roll holder
41508, -000



PuraVida®
Spare roll holder
41518, -000



PuraVida®
WC brush with
ceramic tumbler
41505, -000



PuraVida®
Towel holder,
twin-handle
41512, -000



PuraVida®
Grab rail, 300 mm
41513, -000



PuraVida®
Bath towel rail, 600 mm
41506, -000

Metris®

To suit every customer



Metris® 110



User-friendly: Five basin mixer heights are available offering the right solution for any installation situation.



Elegant: Generous handle and spout surfaces lend the bathroom a luxurious ambience.



Modern: Metris mixers are designed for discretion, providing space for the personal ComfortZone.



Advantages and benefits

- Generous surfaces for elegant, quality bathroom design
- The open sweep of the flat handle reflects its ease of use
- Tapered base and precision edges emphasise the character of quality
- Five basin mixer heights for individual free space
- Automatic flow limit to 5 l/min thanks to EcoSmart technology

Basin/bidet



Metris® 260
Single lever basin mixer
31082, -000 with pop-up waste set
31184, -000 without waste set



Metris® 230
Single lever basin mixer
with 120° swivel spout
31087, -000 with pop-up waste set
31187, -000 with Push-Open waste
31081, -000 without waste set



Metris® 200
Single lever basin mixer
31183, -000 with pop-up waste set
31185, -000 without waste set



Metris® 110
Single lever basin mixer
31080, -000 with pop-up waste set
31084, -000 without waste set
31203, -000 LowFlow with pop-up waste set
31074, -000 for open water heaters
31204, -000 LowFlow for open water heaters
31121, -000 CoolStart with pop-up waste set
(not shown)



Metris® 100
Single lever basin mixer
31088, -000 with pop-up waste set
31186, -000 without waste set



Metris® 100
3-hole basin mixer
31083, -000 with fixed spout



Metris®
Single lever basin mixer for wall installation
31086, -000 225 mm
31085, -000 165 mm (not shown)
Basic set for concealed installation
13622180



Metris®
Pillar tap for small wash basin
31166, -000



Metris®
Single lever bidet mixer
31280, -000 with pop-up waste set



Metris®

Bath



Metris®
Single lever bath mixer
exposed
31480, -000



Metris®
Single lever bath mixer
concealed
31493, -000
31487, -000 with safety combination



Metris®
Single lever bath mixer
concealed
31454, -000
31451, -000 with safety combination



Metris®
Bath filler
exposed
31494, -000



Metris®
3-hole rim-mounted mixer
31190, -000
Basic set for concealed installation
13437180



Metris®
4-hole bath mixer
for rim-mounted installation
31442, -000
Basic set for concealed installation
13444180



Metris®
Single lever bath mixer,
floor standing, with PuraVida
120 1jet baton hand shower
31471, -000
Basic set for concealed
installation
10452180

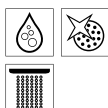

- No broken tiles thanks to pre-assembled basic set
- Secuflex Box protects the shower hose behind the bath
- Shower hose does not catch when used
- Easy servicing thanks to completely sealed system and easy access from above

Shower



Metris®
Single lever shower mixer
exposed
31680, -000



Metris®
Single lever shower mixer
concealed
31685, -000



Metris®
Single lever shower mixer
concealed
31456, -000



Metris®
Thermostat
concealed
31572, -000 for 1 function (not shown)
31573, -000 for 2 functions



Metris®
Thermostat
concealed
31570, -000
Highflow Thermostat
31571, -000 (not shown)



iControl® S
Valve for 3 functions
concealed
15955, -000

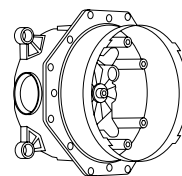

**Basic set for concealed
thermostats and mixers**
01800180 iBox universal



Metris® S

Basin



Metris® S
Single lever basin mixer
31022, -000 with pop-up waste set
31023, -000 without waste set



Metris® S
Single lever basin mixer
31021, -000 with pop-up waste set
31026, -000 without waste set



Metris® S
Single lever basin mixer
with 120° swivel spout
31159, -000 with pop-up waste set
31161, -000 with Push-Open waste



Metris® S
Single lever basin mixer
31060, -000 with pop-up waste set
31068, -000 without waste set
31063, -000 LowFlow



Metris® S
Single lever basin mixer for wall installation
31162, -000 165 mm (not shown)
31163, -000 225 mm
Basic set for concealed installation
13622180



Metris® S
Electronic basin mixer with temperature control
31100, -000 Battery operation
31102, -000 Mains connection 230 V
without temperature control
31101, -000 Battery operation (not shown)
31103, -000 Mains connection 230 V (not shown)



Bidet



Metris® S
Single lever bidet mixer
31261, -000 with pop-up waste set

Bath



Metris® S
Single lever bath mixer
exposed
31460, -000



Metris® S
Single lever bath mixer
concealed
31465, -000
31466, -000 with safety combination



Metris® S
Bath filler
exposed
14420, -000



Metris® S
4-hole bath mixer
for rim-mounted installation
31446, -000 170 mm
31447, -000 220 mm
13444180 Basic set for concealed
installation

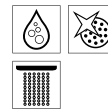

Shower



Metris® S
Single lever shower mixer
exposed
31660, -000



Metris® S
Single lever shower mixer
concealed
31665, -000

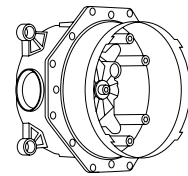

**Basic set for concealed
thermostats and mixers**
01800180 iBox universal



- Metris S presents a timeless design with a clear, precise flow of lines
- Ergonomic pin handle emphasises the precision of the design languages
- Extensive range for every application
- Also ideal for large scale projects



Talis® Select S/Talis® S

NEW

This is where form and function blend

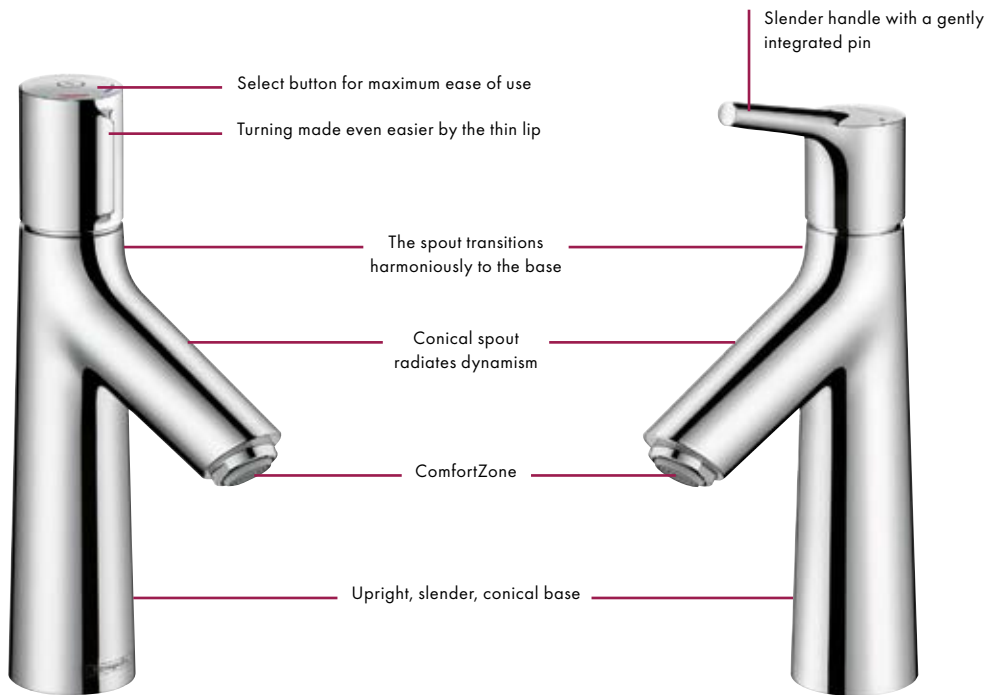

Talis® Select S 100

Talis® S 100



User-friendly: Whether with a finger, arm or elbow – the Select button makes operation easier than ever. The temperature can remain pre-set.



Fine form: Because the Select button has no lever, the mixer always looks symmetrical. There is no need to turn back the lever, and the water temperature is instantly correct.



Natural: Harmonious integration of the mixers in the bathroom thanks to the naturally blending pipe bodies.



Advantages and benefits

- Select technology makes daily routines easier at the touch of a button
- Helps to save water, since the easy operation encourages the user to keep switching it off
- **Easy to clean:** thanks to the clear conical shapes
- Automatic flow limit to 5 l/min thanks to EcoSmart technology

NEW

Basin



Talis® Select S 190
Basin mixer
72044, -000 with pop-up waste set
72045, -000 without waste set



Talis® Select S 100
Basin mixer
72042, -000 with pop-up waste set
72043, -000 without waste set



Talis® Select S 80
Basin mixer
72040, -000 with pop-up waste set
72041, -000 without waste set



Talis® S 190
Single lever basin mixer
72031, -000 with pop-up waste set
72032, -000 without waste set



Talis® S 100
Single lever basin mixer
72020, -000 with pop-up waste set
72021, -000 without waste set
72022, -000 CoolStart with pop-up waste set (not shown)
72023, -000 CoolStart without waste set (not shown)
72024, -000 LowFlow with pop-up waste set
72025, -000 LowFlow without waste set



Talis® S 80
Single lever basin mixer
72010, -000 with pop-up waste set
72011, -000 with Push-Open waste
72012, -000 without waste set
72013, -000 CoolStart with pop-up waste set (not shown)
72014, -000 CoolStart without waste set (not shown)
72015, -000 LowFlow with pop-up waste set
72018, -000 LowFlow without waste set
72016, -000 for open water heaters
72017, -000 Pillar tap (not shown)



Talis® Select S/Talis® S

NEW

Basin



Talis® S 250
Single lever basin mixer
72115, -000 with pop-up waste set
72116, -000 without waste set

Available from Q1/2016



Talis® S 140
Single lever basin mixer
72113, -000 with pop-up waste set
72114, -000 without waste set

Available from Q1/2016



Talis® S 210
Single lever basin mixer
with 120° swivel spout
72105, -000 with pop-up waste set

Available from Q1/2016



- Easy operation thanks to the easy-to-reach pin handle
- **Easy to clean** since the handle on the side means less dirt
- Entirely new design language for additional customer groups
- Suitable for large basins



Talis® S
3-hole basin mixer
72130, -000

Available from Q1/2016



Talis® S
Single lever basin mixer for wall installation
72111, -000 225 mm
Basic set for concealed installation
13622180



Talis® S
Single lever basin mixer for wall installation
72110, -000 165 mm
Basic set for concealed installation
13622180



Bidet



Talis® Select S
Bidet mixer
72202, -000



Talis® S
Single lever bidet mixer
72200, -000



NEW

Bath



Talis® S
3-hole rim-mounted mixer
72415, -000
Basic set for concealed installation
13233180

Available from Q1/2016



Talis® S
3-hole rim-mounted mixer
72416, -000
Basic set for concealed installation
13437180

Available from Q1/2016



Talis® S
4-hole bath mixer
for rim-mounted installation
72418, -000
Basic set for concealed installation
13444180

Available from Q1/2016



Talis® S
Bath filler
exposed
72410, -000

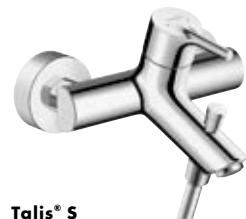

Talis® S
Single lever bath mixer
exposed
72400, -000



Talis® S
Single lever bath mixer
concealed
72405, -000
72406, -000 with safety combination



Talis® S
Single lever bath mixer, floor
standing, with Axor Starck
baton hand shower
72412, -000
Basic set for concealed
installation
10452180

Available from Q1/2016

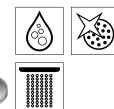

Shower



Talis® S
Single lever shower mixer
exposed
72600, -000



Talis® S
Single lever shower mixer
concealed
72605, -000
72607, -000 Highflow (not shown)

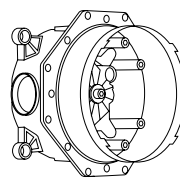

**Basic set for concealed
thermostats and mixers**
01800180 iBox universal

Talis®/Talis® S

Basin



Talis® 250
Single lever basin mixer
with 60° swivel spout
32055, -000 with Push-
Open waste



Talis® 210
Single lever basin mixer
with 120° swivel spout
32082, -000 with Push-
Open waste
32084, -000 with pop-up
waste set
32080, -000 with fixed
spout



Talis® S
Single lever basin mixer
32070, -000 with 360°
swivel spout and
waste system
32073, -000 120° swivel
spout and waste system



Talis® 150
Single lever basin mixer
with swivel spout
32052, -000 with pop-up
waste set



Talis® 80
Single lever basin mixer
with swivel spout
32053, -000 with pop-up waste set



Talis® 80
Single lever basin mixer
32040, -000 with pop-up waste set
32041, -000 without waste set
32046, -000 LowFlow with pop-up
waste set
32146, -000 LowFlow without waste
set
32042, -000 for open water heaters
32057, -000 CoolStart with pop-up
waste set (not shown)



Talis® 80
Pillar tap for small wash basin
32130, -000
13132, -000 (not shown)



Talis® S
Single lever basin mixer
32020, -000 with pop-up waste set
32031, -000 without waste set
32032, -000 with pop-up outflow
fitting, for open water heaters



Talis® 200
2-handle basin mixer
with 120° swivel spout
32030, -000



Talis® 230
3-hole basin mixer
32310, -000



Talis®
Single lever basin mixer
for wall installation
31618, -000 165 mm
31620, -000 165 mm LowFlow
31611, -000 225 mm (not shown)
13622180 Basic set for concealed
installation



Bidet



Talis®
Single lever bidet mixer
32240, -000



Talis® S
Single lever bidet mixer
32220, -000



Bath



Talis®
Single lever bath mixer
exposed
32440, -000



Talis® S
Single lever bath mixer
exposed
32420, -000



Talis®
Single lever bath mixer
concealed
32475, -000
32477, -000 with safety combination



Talis®
Bath filler
exposed
13414, -000



Shower



Talis®
Single lever shower mixer
exposed
32640, -000



Talis® S
Single lever shower mixer
exposed
32620, -000



Talis®
Single lever shower mixer
concealed
32675, -000

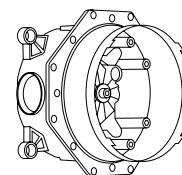

**Basic set for concealed
thermostats and mixers**
01800180 iBox universal



- Talis and Talis S mixers offer exclusive bathroom designs with functional clarity
- Slender and unadorned design
- Characteristic pin handle for ease of use
- Talis with the swivel spout provides an arc shaped water jet for larger ComfortZones



Escutcheon diameter Talis and Talis S: 150 mm. **Matching valves** can be found on page 110.

Talis® Select E/Talis® E

NEW

Comfort in its most natural form

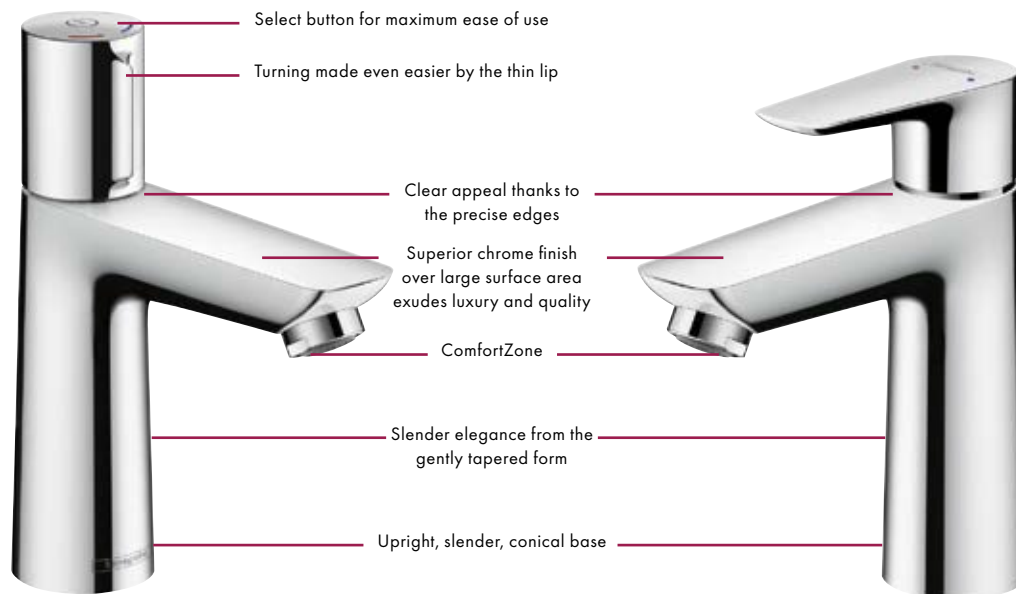

Talis® Select E 110

Talis® E 110

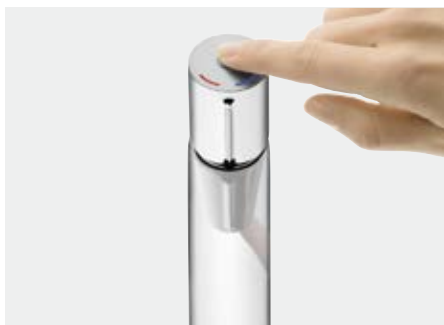

User-friendly: Whether with a finger, arm or elbow - the Select button makes operation easier than ever.



Fine form: Because the Select button has no lever, the mixer always looks symmetrical. There is no need to turn back the lever, and the water temperature is instantly correct.



Elegant: With their precise edges, the mixers contribute to the overall look of harmony in the modern bathroom.



Advantages and benefits

- Select technology makes daily routines easier at the touch of a button
- **Easy to clean:** thanks to the generous areas
- Helps to save water, since the easy operation encourages the user to keep switching it off
- Automatic flow limit to 5 l/min thanks to EcoSmart technology

NEW

Basin



Talis® Select E 240
Basin mixer
71752, -000 with pop-up waste set
71753, -000 without waste set

Available from Q1/2016



Talis® Select E 110
Basin mixer
71750, -000 with pop-up waste set
71751, -000 without waste set

Available from Q1/2016

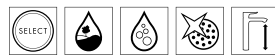

Talis® E 240
Single lever basin mixer
71716, -000 with pop-up waste set
71717, -000 without waste set



Talis® E 110
Single lever basin mixer
71710, -000 with pop-up waste set
71711, -000 with Push-Open waste
71712, -000 without waste set
71713, -000 CoolStart with pop-up waste set (not shown)
71714, -000 CoolStart without waste set (not shown)
71715, -000 LowFlow with pop-up waste set
71709, -000 LowFlow without waste set



Talis® E 80
Single lever basin mixer
71700, -000 with pop-up waste set
71701, -000 with Push-Open waste
71702, -000 without waste set
71703, -000 CoolStart with pop-up waste set (not shown)
71704, -000 CoolStart without waste set (not shown)
71705, -000 LowFlow with pop-up waste set
71708, -000 LowFlow without waste set
71707, -000 for open water heaters
71706, -000 Pillar tap (not shown)



Talis® E

NEW

Basin



Talis® E 150
Single lever basin mixer
71754, -000 with pop-up waste set
71755, -000 without waste set

Available from Q1/2016



Talis® E
3-hole basin mixer
71733, -000

Available from Q1/2016



Talis® E
Single lever basin mixer for wall installation
71732, -000 165 mm
71734, -000 225 mm (not shown)



- Easy operation thanks to the easy-to-reach pin handle
- **Easy to clean** since the handle on the side means less dirt
- Entirely new design language for additional customer groups
- Suitable for large basins

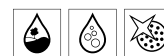

Bidet



Talis® E
Single lever bidet mixer
71720, -000 with pop-up waste set
71721, -000 with Push-Open waste



NEW

Bath



Talis® E
3-hole rim-mounted mixer
71747, -000
Basic set for concealed installation
13233180

Available from Q1/2016



Talis® E
3-hole rim-mounted mixer
71730, -000
Basic set for concealed installation
13437180

Available from Q1/2016



Talis® E
4-hole bath mixer
for rim-mounted installation
71748, -000
Basic set for concealed installation
13444180

Available from Q1/2016



Talis® E
Single lever bath mixer
exposed
71740, -000



Talis® E
Single lever bath mixer
concealed
71745, -000
71474, -000 with safety combination



Talis® E
Bath filler
exposed
71410, -000



Shower



Talis® E
Single lever shower mixer
exposed
71760, -000



Talis® E
Single lever shower mixer
concealed
71765, -000

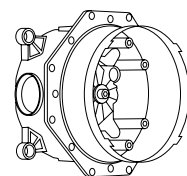

Basic set for concealed thermostats and mixers
01800180 iBox universal

Focus®

With top quality, comfort and great value



Focus® 100



User-friendly: Gentle, caressing roundness and the ergonomic handle invite you to try out the ease of use.



Living: The cylindrical, contemporary body of Focus mixers brings elegance and value to the bathroom.



Advantages and benefits

- Design complete in itself and expressed in a clear, generous language
- Dynamic silhouette and gentle round shapes emphasise the quality
- Ergonomic handle for ease of use
- Excellent value with a high level of comfort
- Automatic flow limit to 5 l/min thanks to EcoSmart technology

Basin/bidet



Focus® 240
Single lever basin mixer
with 120° swivel spout
31609, -000 with pop-up
waste set
31519, -000 without waste
set



Focus® 190
Single lever basin mixer
31608, -000 with pop-up
waste set
31518, -000 without waste
set



Focus® 100
Single lever basin mixer
31607, -000 with pop-up
waste set
31517, -000 without waste set
31603, -000 LowFlow with
pop-up waste set
31513, -000 LowFlow without
waste set
31621, -000 CoolStart with
pop-up waste set (not shown)



Focus® 70
Single lever basin mixer
31730, -000 with pop-up waste
set
31733, -000 without waste set
31951, -000 LowFlow with
pop-up waste set
31952, -000 LowFlow without
waste set
31132, -000 for open water
heaters
31604, -000 with Push-Open
waste
31130, -000 Pillar tap
(not shown)
31539, -000 CoolStart with
pop-up waste set (not shown)

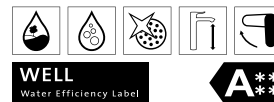

Focus®
Single lever basin mixer for wall
installation
31923, -000



Focus®
Electronic basin mixer with
temperature control
31171, -000 Battery
operation
31173, -000 Mains
connection 230 V



Focus®
Electronic basin mixer without
temperature control
31172, -000 Battery
operation
31174, -000 Mains
connection 230 V



Focus®
Single lever bidet mixer
31920, -000 with pop-up
waste set
31922, -000 with Push-Open
waste



Bath



Focus®
Single lever bath mixer
exposed
31940, -000



Focus®
Single lever bath mixer
concealed*
31945, -000
31946, -000 with safety
combination



Focus®
Bath filler
exposed
13414, -000



Shower



Focus®
Single lever shower mixer
exposed
31960, -000



Focus®
Single lever shower mixer
concealed*
31965, -000



Kitchen mixers in the Focus line can be found on pages 194 onwards.

Escutcheon diameter Focus: 150 mm. ***Basic set for concealed mixers** # 01800180 iBox universal.

Focus Care products for persons of restricted mobility can be found on pages 174 onwards.

Logis®

NEW

Harmonious design with precision feeling



Logis® 100



Pleasing: The precise shoulder lines and rounded edges delight both the eye and the hand.



Flexible: The extensive range has the best and most irresistible solution for any installation situation.



Homely: Thanks to the gentle silhouettes, the Logis mixers create a harmonious atmosphere.



Advantages and benefits

- Clear, generous surfaces for easy operation and cleaning
- The rounded shapes of the handle and base make them the perfectly matching complements to the soft edges of the basin
- High-value, quiet ceramic cartridge – perfect for apartment blocks, hotels and offices
- High value in the lower price category
- Extensive range with various basin mixer heights
- Automatic flow limit to 5 l/min thanks to EcoSmart technology

NEW

Basin/bidet



Logis® 210
 Single lever basin mixer
 with 120° swivel spout
 # 71130, -000 with pop-up waste set
 # 71131, -000 without waste set



Logis® 190
 Single lever basin mixer
 # 71090, -000 with pop-up waste set
 # 71091, -000 without waste set



Logis® 100
 Single lever basin mixer
 # 71100, -000 with pop-up waste set
 # 71107, -000 with Push-Open waste set
 # 71102, -000 CoolStart with pop-up waste set (not shown)
 # 71103, -000 CoolStart without waste set (not shown)
 # 71101, -000 without waste set



Logis® 70
 Single lever basin mixer
 # 71070, -000 with pop-up waste set
 # 71077, -000 with Push-Open waste set
 # 71072, -000 CoolStart with pop-up waste set (not shown)
 # 71073, -000 CoolStart without waste set (not shown)
 # 71071, -000 without waste set
 # 71074, -000 for open water heaters
 # 71078, -000 with pop-up waste set



Logis®
 Single lever basin mixer
 for wall installation
 # 71220, -000 195 mm
 # 13622180 Basic set for
 concealed installation



Logis®
 Single lever basin mixer for wall installation
 Exposed
 # 71225, -000



Logis®

NEW

Basin



Logis®
3-hole basin mixer
71133, -000 with pop-up waste set



Logis®
2-handle basin mixer
71222, -000 with pop-up waste set
71221, -000 without waste set



Logis® 70
Pillar tap
71120, -000 Cold water
71121, -000 Warm water (not shown)



Bidet



Logis® 70
Single lever bidet mixer
71204, -000



Logis® 100
Single lever bidet mixer
71200, -000



NEW

Bath



Logis
Single lever bath mixer
exposed
71400, -000



Logis
2-handle bath mixer exposed installation
71243, -000



Logis
Single lever bath mixer
concealed
71405, -000
71407, -000 with safety combination



Logis
Bath filler
exposed
71410, -000



Logis
3-hole rim-mounted mixer
71310, -000
Basic set for concealed installation
13437180



Shower



Logis
Single lever shower mixer
exposed
71600, -000



Logis
2-handle shower mixer exposed installation
71263, -000



Logis
Single lever shower mixer
concealed
71605, -000
71607, -000 Highflow (not shown)



Logis
Shut-off valve
71970, -000

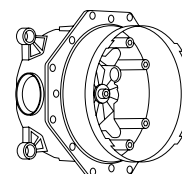

**Basic set for concealed
thermostats and mixers**
01800180 iBox universal

Bath mixers – Logis

Metris® Classic

Modern classic with elegant design



Metris® Classic 100



Elegant: The brilliant and smooth surface of the mixers presents highlights of luxury in every bathroom.



Classical: The elegant design with discreetly shaped handle and spout emanate high quality and pleasure.



Advantages and benefits

- Balanced, minimal design with unpretentious classical elegance
- Automatic flow limit to 5 l/min thanks to EcoSmart technology
- Very slender and easy to operate thanks to the M1 cartridge
- Connected via temperature-resistant, taste- and odour-neutral PEX hoses
- **Easy to clean:** thanks to the exclusive, long-lasting chrome surface
- With scald protection for added safety

Basin/bidet



Metris® Classic 250
Single lever basin mixer
31078, -000 with pop-up
waste set



Metris® Classic 100
Single lever basin mixer
31075, -000 with pop-up
waste set
31077, -000 without waste
set



Metris® Classic
Single lever basin mixer for
wall installation
31003, -000 225 mm
Basic set for concealed
installation
13622180



Metris® Classic 100
3-hole basin mixer
31073, -000 with pop-up
waste set



Metris® Classic
Single lever bidet mixer
31275, -000 with pop-up
waste set



Bath



Metris® Classic
Single lever bath mixer
exposed
31478, -000



Metris® Classic
Single lever bath mixer
concealed
31485, -000



Metris® Classic
Bath filler
exposed
13413, -000



Shower



Metris® Classic
Single lever shower mixer
exposed
31672, -000



Metris® Classic
Single lever shower mixer
concealed
31676, -000



Fixfit® Classic
DN15 hose connection with
non-return valve
16884, -000

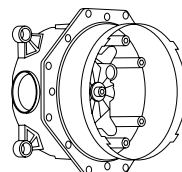

**Basic set for concealed
thermostats and mixers**
01800180 iBox universal

Talis® Classic

The harmony of classic elegance



Talis® Classic 80



Natural: The mixers in the Talis Classic line combine original charm and pioneering water saving technology.



Supreme: Geometrical transitions, refined sweeps and discreet lines introduce a calm, yet exciting style to the bathroom.



Advantages and benefits

- Cylindrical basic form and tall geometry emanate elegance
- Very slender and easy to operate thanks to the M1 cartridge
- Pin handle for ease of use
- Automatic flow limit to 5 l/min thanks to EcoSmart technology
- Connected via temperature-resistant, taste- and odour-neutral PEX hoses
- With scald protection for added safety

Basin/bidet



Talis® Classic 230
Single lever basin mixer
14116, -000 with pop-up
waste set



Talis® Classic 80
Single lever basin mixer
14111, -000 with pop-up
waste set
14118, -000 without waste
set



Talis® Classic Natural 90
Single lever basin mixer
14127, -000 with pop-up
waste set



Talis® Classic
Single lever bidet mixer
14120, -000 with pop-up
waste set



Bath



Talis® Classic
Single lever bath mixer
exposed
14140, -000



Talis® Classic
Single lever bath mixer
concealed
14145, -000

Shower



Talis® Classic
Single lever shower mixer
exposed
14161, -000



Talis® Classic
Single lever shower mixer
concealed
14165, -000

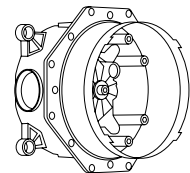

**Basic set for concealed
thermostats and mixers**
01800180 iBox universal



Logis® Classic

NEW

The perfect blend of elegance and functionality

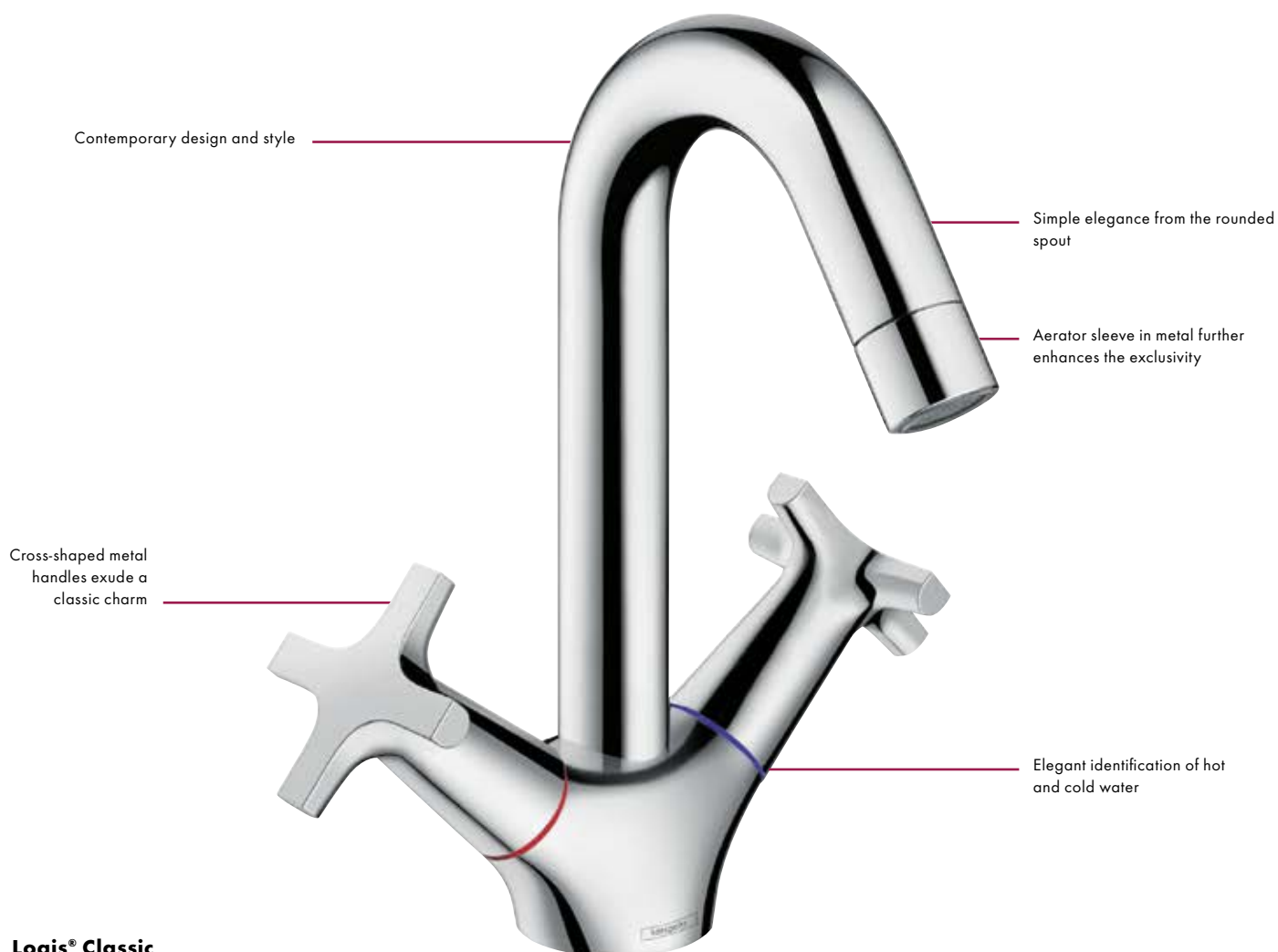

Logis® Classic



Advantages and benefits

- Elegant design with classic elements
- Basic shape adapted to the basin for harmonious integration
- **Easy to clean:** thanks to the clear cylindrical shapes
- Swivel range limited for easier handling
- Long-lasting ceramic valves in the entire range
- Automatic flow limit to 5 l/min thanks to EcoSmart technology
- Also available as low-pressure versions
- Hansgrohe quality at entry-level prices

NEW

Basin



Logis® Classic
2-handle basin mixer
71270, -000 with pop-up waste set
71272, -000 with Push-Open waste



Logis® Classic
3-hole basin mixer
71323, -000 with pop-up waste set



Logis® Classic
Pillar tap
71135, -000 Cold water
71136, -000 Warm water (not shown)



Bath



Logis® Classic
2-handle bath mixer exposed installation
71240, -000



Shower



Logis® Classic
2-handle shower mixer exposed installation
71260, -000



Logis® Classic
Shut-off valve
71976, -000

Care mixers

More comfort and safety with Hansgrohe Care

Longer handles, intuitive use, constant temperatures, large lettering: The mixers in the Talis Care and Focus Care lines and the Ecostat Comfort Care thermostats provide that extra safety, comfort and ease of use in the bathroom.

The resulting ease in handling water offers particular benefits to families with small children. These perfected solutions are ideal wherever people are in need of assistance owing to their age or illness or wherever

special hygiene conditions apply: i. e. at retirement homes, hospitals, health resorts, or hospices. But also where greater ease of use and safety are required, for instance in nursery schools, or hotels.



Focus® Care

Single lever basin mixer

Ecostat® Comfort Care

Shower thermostat



Advantages and benefits

- Extra long, flat control lever: ergonomically formed for the whole hand or arm
- Comfortable use under a light touch
- Robust brass body and metal handle for a particularly long lifetime
- Temperature preset, e. g. for people who have lost their feeling for hot and cold

Talis® Care

Basin



Talis® Care 80
Single lever basin mixer
32035, -000



Talis® Care
Single lever basin mixer
exposed
32037, -000

Bath



Ecostat® Comfort Care
Bath thermostat
exposed
13115, -000

Shower



Talis® Care
Single lever shower mixer
exposed
32641, -000



Ecostat® Comfort Care
Shower thermostat
exposed
13117, -000



Focus® Care

Basin



Focus® Care 100
Single lever basin mixer
31911, -000 with pop-up
waste set
31915, -000 without waste
set
31917, -000 CoolStart
without waste set (not shown)



Focus® Care 70
Single lever basin mixer
31910, -000 with pop-up
waste set
31914, -000 without waste
set



Focus® Care
Single lever basin mixer
exposed
31913, -000

Shower



Focus® Care
Single lever shower mixer
exposed
31916, -000



- User optimised lever length 121 mm
- Strong metal body and handle
- Laminar spray



Under-basin thermostat
exposed
15346, -000



Quick coupling
28346, -000



- Easy to connect to existing valves, e.g. under the basin
- Provides a constant temperature and consistent flow even with fluctuating cold water pressure
- Safety e.g. in nursery schools, hospitals or hotels
- Safe for thermal disinfection

- For quick, easy emptying of hoses

Electronic basin mixer

Sensors for greater hygiene and water savings

Here, water flows only when it is actually needed: Contactless mixers with infrared proximity electronics are especially useful in public facilities for saving water – and

hence for cutting the costs of consumption and energy. In addition, the contactless technology eliminates the risk of contamination associated with heavily used mixers in public and

corporate washrooms. Above all on the care and health sectors, hygiene experts recommend sensor controlled water sources.



Focus®
Electronic basin mixer



Advantages and benefits

- Water savings thanks to automatic stop
- Available for battery and mains connection
- Contactless, so particularly hygienic
- Ideal for public and business sectors
- WELL certified

Electronic basin mixer

PuraVida®



PuraVida®

Electronic basin mixer with temperature control
 # 15170, -000, -400 Battery operation
 # 15172, -000, -400 Mains connection 230 V



Metris® S



Metris® S

Electronic basin mixer with temperature control
 # 31100, -000 Battery operation
 # 31102, -000 Mains connection 230 V



Metris® S

Electronic basin mixer without temperature control
 # 31101, -000 Battery operation
 # 31103, -000 Mains connection 230 V



Focus®



Focus®

Electronic basin mixer with temperature control
 # 31171, -000 Battery operation
 # 31173, -000 Mains connection 230 V



Focus®

Electronic basin mixer without temperature control
 # 31172, -000 Battery operation
 # 31174, -000 Mains connection 230 V



Accessories

Logis®



Liquid soap dispenser
Glass
40514, -000



Toothbrush tumbler
Glass
40518, -000



Soap dish
Glass
40515, -000



Towel hook
40511, -000



Roll holder
40523, -000



Roll holder
without cover
40526, -000



Spare roll holder
40517, -000



Toilet brush tumbler
Glass
40522, -000



Towel holder
twin-handle
40512, -000



Grab rail
300 mm
40513, -000



Bath towel rail
600 mm
40516, -000

Logis® Classic



Liquid soap dispenser
Ceramics
41614, -000



Toothbrush tumbler
Ceramics
41618, -000



Soap dish
Ceramics
41615, -000



Towel hook
41611, -000



Roll holder
41623, -000



Roll holder
without cover
41626, -000



Spare roll holder
41617, -000



Toilet brush tumbler
Ceramics
41632, -000



Towel holder
twin-handle
41612, -000



Grab rail
300 mm
41613, -000



Bath towel rail
600 mm
41616, -000

Hansgrohe waste systems

Discreet design, perfect function

Cleanliness is indispensable for well being in the bathroom. For this reason, Hansgrohe has developed a large number of innovative waste systems. The used water can

then drain off quickly and easily. Flexible models like Exafill, Flexaplust, Raindrain and Flowstar are easy to install and in addition are perfectly easy to use. Overflow control and

other intelligent functions maintain comfort on a high level for a very long time.



Push-Open: The Push-Open waste is opened and closed at the tap of a finger and water can collect and drain off very easily.



Flowstar®: The Flowstar waste system also presents a visually clean solution under the wash basin.



Exafill® S bath: The integrated fine flood spray fills the bath easily and free of splashes, so a separate bath filler is not needed. Exafill S is everything in one: bath filler, outflow and overflow. Better still: The installation is pleasantly uncomplicated - and with QuickClean technology cleaning the filler nozzles is just as easy.



Flexaplust® S bath: Never again a bath that has run too full. The outflow and overflow mixer regulates excess bath water through the overflow control element. In addition, the water level in the bath can be raised by up to 25 mm - for even more bath fun.



Raindrain® 90 XXL shower: Ideal for large showers with high flow rates like Raindance Rainfall or Raindance Rainmaker. Provides for a fast and uncomplicated outflow in all shower trays. The perfect shower outflow with a max capacity of 51 l/min and easy installation.



Advantages and benefits

- Water can drain off quickly and easily
- Easy to install and use
- Reliable even for large showers with high flow rates
- Overflow control and other intelligent functions

Siphons



Flowstar® designer siphon

52100, -000
Set: 1 Flowstar,
2 angle valve bolts
(without angle valve)
52110, -000 (not shown)
Set: 1 Flowstar,
2 angle valve bolts
(incl. angle valve)
52120, -000 (not shown)



Flowstar® S designer siphon

52105, -000



Angle valve E

13902, -000



Angle valve S

13901, -000



Free-flow waste

Push-Open
50100, -000



Free-flow waste

Push-Open
50105, -000



Free-flow waste

with closed cover plate
50001, -000, -800



Waste set

with tilting lever
94139, -000

Waste systems for showers



Raindrain® 90 XXL
Complete set 51 l/min
60067, -000



- Flow performance max 51 l/min
- Easy installation



Staro® '90
Complete set 29 l/min
60056, -000



Staro® '90
Basic set 29 l/min
60054180



Staro® '90
Finish set
60055, -000



Staro® '52
Complete set 33 l/min
60060, -000



Starolift® '52
Basic set 33 l/min
60052180



Starolift® '52
Finish set
60053, -000

Waste systems for bath tubs



Flexaplusth
58143, -000
Waste and overflow complete set with flexible hose for standard tubs



Flexaplusth S
58150, -000
Waste and overflow complete set with flexible hose for standard tubs



Flexaplusth
58140180
Waste and overflow basic set with flexible hose for standard tubs



Flexaplusth
58141180
Waste and overflow basic set with flexible hose for special tubs



- Spring loaded plug protects against injury
- Self cleaning screw siphon

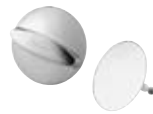

Flexaplusth
58185, -000 Finish set



Flexaplusth S
58186, -000 Finish set



Exafillh
58123, -000
Bath filler with waste and overflow complete set for standard tubs



Exafillh
58125180
Bath filler with waste and overflow basic set for standard tubs



Exafillh
58126180
Bath filler with waste and overflow basic set for special tubs



Exafillh
58127, -000 Finish set



Exafillh S
58113, -000
Bath filler with waste and overflow complete set for standard tubs



Exafillh S
58115180
Bath filler with waste and overflow basic set for standard tubs



Exafillh S
58116180
Bath filler with waste and overflow basic set for special tubs



Exafillh S
58117, -000
Finish set



- Flexibly adaptable to bath forms

KITCHEN MIXERS

Mixer diversity where know-how quality, functionality and design come together:

PuraVida® | Metris® Select | Metris® | Talis® Select S | Talis® S | Focus® | Logis® | Logis® Classic



Select technology

Comfort at the touch of a button – to suit your customers' taste

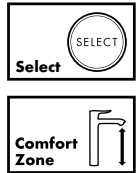

The innovative Select technology provides extremely comfortable operation at the touch of a button – including in the kitchen of course. Many people find cooking helps them to relax and switch off. And switching off is the key. With the Select button, it happens

literally at the touch of a hand – or elbow. This keeps the mixer clean even if the user has dirty hands. It's easier to turn the water off between various tasks, which means it's also easier to avoid wasting water. So cooking remains relaxing thanks to the modern yet practical





design of Hansgrohe's kitchen mixers – even the pull-out spray is available with Select technology. Intelligent handling then turns cooking into a real pleasure.









More freedom of movement: The Select button is operated almost in passing, bringing added comfort and more flexibility into daily activities.

Hansgrohe kitchen mixers

The kitchen mixer lines at a glance

	PuraVida®	Metris® Select/Metris®		Talis® Select S/Talis® S	
					
Product name	PuraVida® 280	Metris® Select 320	Metris® 320	Talis® Select S 300	Talis® S 200
With Select technology	-	Yes	-	Yes	-
With pull-out spray	-	-	# 14820, -000, -800	-	# 72813, -000, -800
With pull-out spout	-	# 14884, -000, -800	# 14821, -000, -800	# 72821, -000, -800	-
With swivel spout	# 15805, -000, -800 # 15812, -000, -800	# 14883, -000, -800	# 14822, -000, -800	# 72820, -000, -800	# 72810, -000, -800
For window installation	-	-	# 14823, -000	-	-
For open water heaters	-	-	-	-	# 72812, -000
With shut-off valve	-	-	# 14888, -000	-	-

Versions

Talis® S ² Variarc	Talis® S	Focus®		Logis®		
						
Talis® S² Variarc	Talis® S	Focus® 240	Focus® 160	Logis® 260	Logis® 200	Logis® 160
-	-	-	-	-	-	-
# 14877, -000, -800	# 32841, -000, -800	# 31815, -000, -800	-	-	-	-
# 14872, -000, -800	-	-	-	-	-	-
# 14870, -000, -800	# 32851, -000, -800	# 31817, -000, -800 # 31820, -000, -800	# 31806, -000, -800	# 71835, -000	# 71280, -000	# 71832, -000 # 71830, -000
# 14877, -000, -800 # 14872, -000, -800	-	-	-	-	-	# 71833, -000
# 14873, -000	# 32842, -000 # 32852, -000	# 31822, -000	# 31804, -000	-	-	# 71831, -000
# 14875, -000	# 32855, -000	# 31823, -000	# 31803, -000	-	-	# 71834, -000

PuraVida® 2-hole single lever kitchen mixer

Leaves no wish unfulfilled for perfect ergonomics

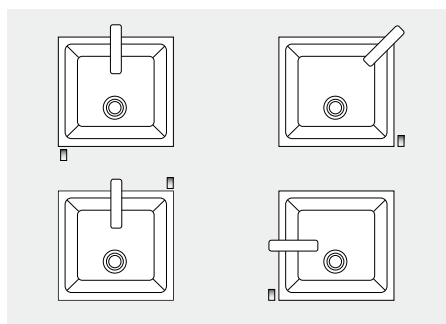

Examples of installation possibilities



PuraVida®
2-hole single lever kitchen
mixer with 120° swivel spout
(Stainless steel look illustrated)
15812, -000, -800



Advantages and benefits

- Used separately from the basic set for impressive aesthetics
- Individual positioning of the mixer and handle around the sink for convenience and ergonomics
- High swivel spout for greater freedom of movement between the spout and sink
- DualFinish with smooth transition from the brushed base to the polished spout

Find out more at <http://pro.hansgrohe-int.com/kitchen>

PuraVida® 2-hole electronic kitchen mixer

Intelligent functionality at the sink



Quick temperature selection



Temperature



Volume



Cleaning

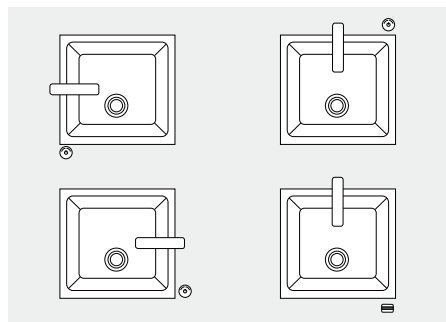
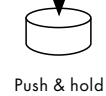

Examples of installation possibilities



PuraVida®
2-hole electronic kitchen mixer
with 120° swivel spout
(Stainless steel look illustrated)
15805, -000, -800



Advantages and benefits

- Used separately from the basic set for impressive aesthetics
- Individual positioning of the mixer and handle around the sink for convenience and ergonomics
- High swivel spout for greater freedom of movement between the spout and sink
- Pressed button and twisting for ease of use
- LED illuminated ring for water temperature
- DualFinish with smooth transition from the brushed base to the polished spout

Find out more at <http://pro.hansgrohe-int.com/kitchen>

Metris® Select

Easy operation is the best recipe

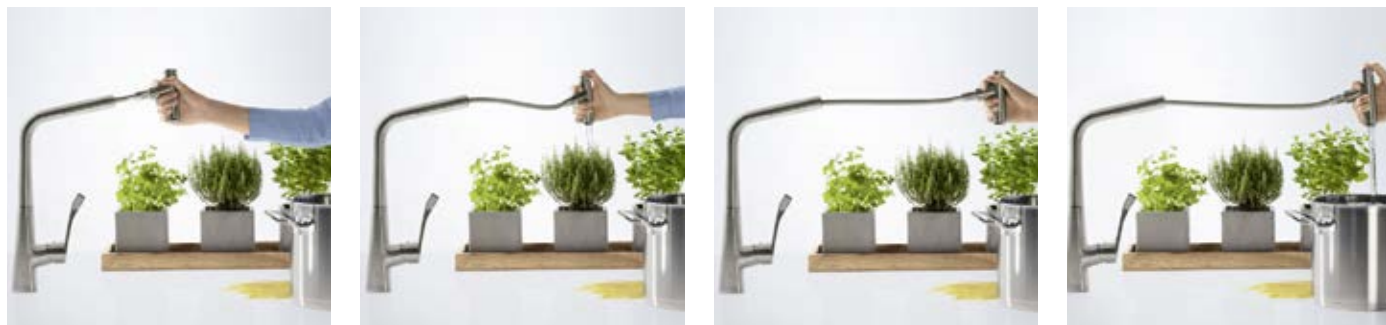
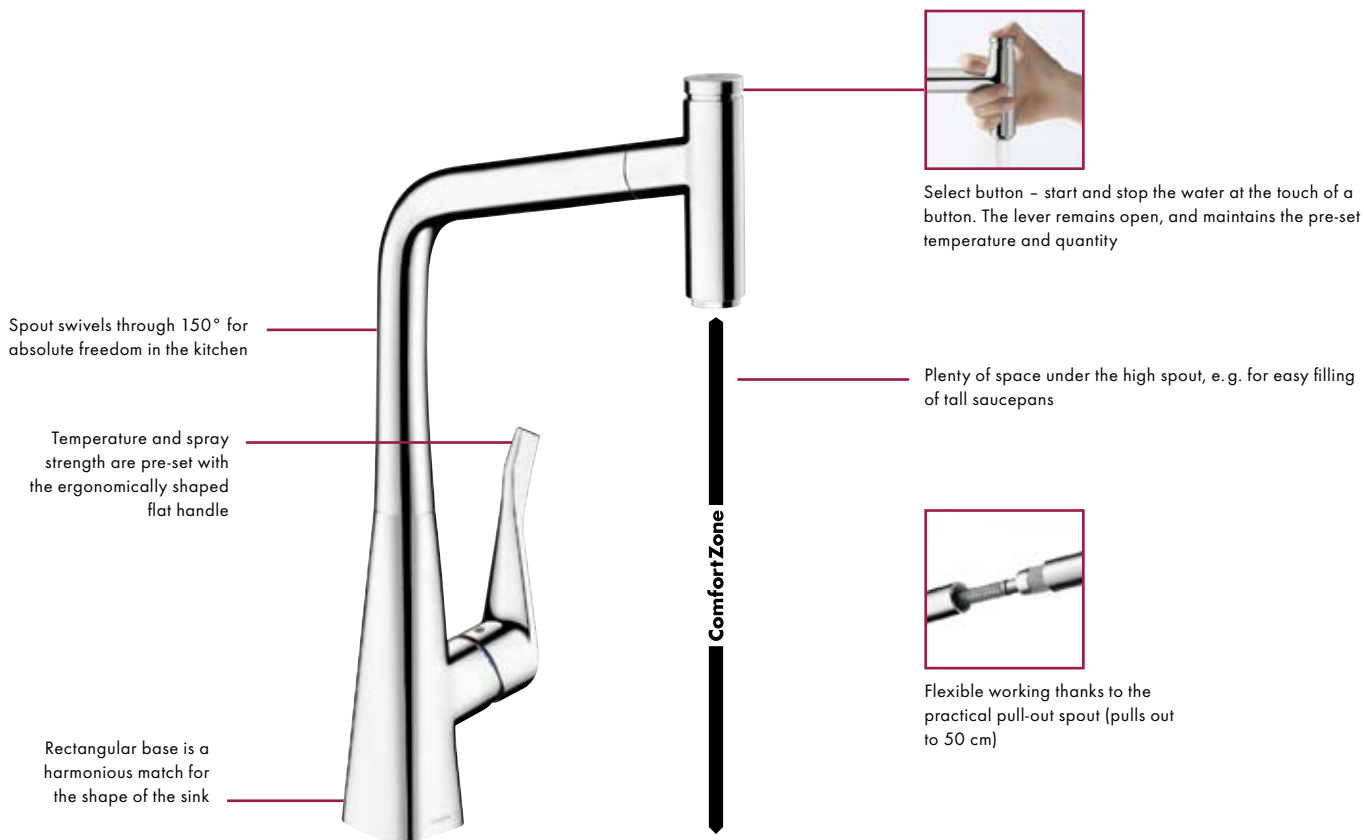

Flexible: Tasks blend seamlessly thanks to the combination of intuitive Select button and practical pull-out spout - for more comfort in the kitchen and beyond the sink.



Advantages and benefits

- Mixer easy to turn on and off at the touch of a button
- Intuitive control concept makes it ideal for all ages
- New spray design for easy handling with no irritating twisting of the wrist
- Ergonomic flat handle design for better adjustment of the water temperature and quantity
- Basic form matches the shape of the sink and integrates harmoniously in the kitchen

Metris® Select

NEW



Metris® Select 320
Single lever kitchen mixer
with pull-out spout,
150° swivel spout
14884, -000, -800



Metris® Select 320
Single lever kitchen mixer
with 110°/150°/360° swivel spout
14883, -000, -800



Metris®

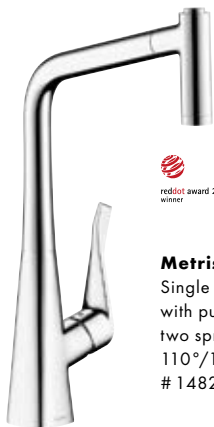

Metris® 320
Single lever kitchen mixer
with pull-out spray,
two spray types,
110°/150° swivel spout
14820, -000, -800



- Vertical handle position
- Pull-out spray with 2 spray types (normal/shower spray)
- Clear, laminar spray for fewer splashes

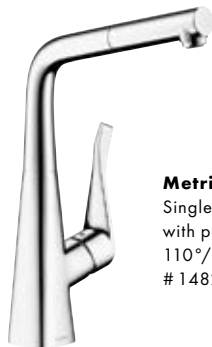

Metris® 320
Single lever kitchen mixer
with pull-out spout,
110°/150° swivel spout
14821, -000, -800

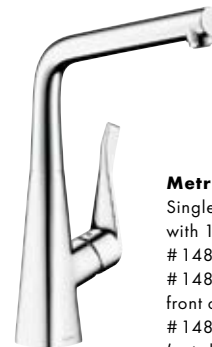

Metris® 320
Single lever kitchen mixer
with 110°/150°/360° swivel spout
14822, -000, -800
14823, -000 for installation in
front of a window (not shown)
14888, -000 with shut-off valve
(not shown)



- Suitable for installation in front of a window
- Available with device shut-off valve

Talis® Select

The all-rounder for the modern kitchen



Versatile: Even containers that are some distance away are easy to reach and fill without splashing thanks to the Select button and the pull-out hose – even with just one hand.

Robust: Whether on the pull-out spray or the 150° swivel spout, the Select button is purely mechanical, which makes it especially robust.



Advantages and benefits

- Select version with intuitive operation at the touch of a button
- Select technology integrated harmoniously in the slender spout
- Conical basic shape radiates a luxurious elegance
- **Easy to clean:** thanks to the large areas and precise transitions
- Two Select mixer types for individual requirements: with pull-out or swivel spout

Talis® Select S/Talis® S

NEW



Talis® Select S 300
Single lever kitchen mixer
with pull-out spout 150°
72821, -000, -800



Talis® Select S 300
Single lever kitchen mixer
with 110°/150°/360°
swivel spout
72820, -000, -800

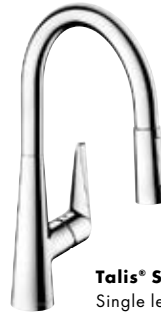

Talis® S 200
Single lever kitchen mixer
with 110°/150° swivel spout
72813, -000, -800



Talis® S 280
Single lever kitchen mixer
with 110°/150°/360°
swivel spout
72810, -000, -800
72812, -000
for open water heaters



- Pulls out to 50 cm
- Two spray types that are easy to set by means of a switch

Talis® S Variarc



Talis® S² Variarc
Single lever kitchen mixer,
two spray types, 150° swivel
spout possible for window
installation
14877, -000, -800



Talis® S² Variarc
Single lever kitchen mixer
with pull-out spout, 150°
swivel spout possible for
window installation
14872, -000, -800



Talis® S² Variarc
Single lever kitchen mixer
with 110°/150°/360°
swivel spout
14870, -000, -800
14873, -000 for open water
heaters
14875, -000 with shut-off
valve (not shown)



Talis® S² Variarc
Single lever kitchen mixer
with pull-out spray, two spray
types, 150° swivel spout
32856, -000



Talis® S



Talis® S
Single lever kitchen mixer
with pull-out spray, two spray
types, 150° swivel spout
32841, -000, -800
32842, -000 for open water
heaters



Talis® S
Single lever kitchen mixer
with 150° swivel spout
32851, -000, -800
32855, -000 with shut-off
valve (not shown)



Talis® Classic



Talis® Classic
Single lever kitchen mixer
with pull-out spray, two spray
types, 150° swivel spout
14864, -000 ComfortZone
210
14863, -000 ComfortZone
240 (not shown)



Talis® Classic
Single lever kitchen mixer
with 150° swivel spout
14858, -000



Focus®



Focus® 240
Single lever kitchen mixer
with pull-out spray, two spray types,
150° swivel spout
31815, -000, -800



Focus® 260
Single lever kitchen mixer
with 110°/150°/360° swivel spout
31820, -000, -800
31822, -000 for open water heaters
31823, -000 with shut-off valve
(not shown)



Focus® 280
Single lever kitchen mixer
with 110°/150°/360° swivel spout
31817, -000, -800



- Pull-out spray with 2 spray types (normal/shower spray)
- MagFit magnetic holder for spray



- Swivel range can be set in three steps (110°/150°/360°)
- Variable handle position (right or left)



Focus® 160
Single lever kitchen mixer
with 360° swivel spout
31806, -000, -800
31804, -000 for open water heaters
31803, -000 with shut-off valve (not shown)



Focus® E
Single lever kitchen mixer
with 360° swivel spout
31780, -000
31784, -000 for open water heaters



Focus® S
Single lever kitchen mixer
with 360° swivel spout
31786, -000
31785, -000 for open water heaters
31783, -000 with shut-off valve
(not shown)



Focus®
Single lever kitchen mixer
for wall installation,
180° swivel spout
31825, -000



Kitchen shut-off valve
10823, -000, -800
to match any Hansgrohe kitchen mixer



Logis®

NEW



Logis® 260
Single lever kitchen mixer
with 110°/150°/360° swivel spout
#71835, -000

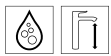

Logis® 200
2-handle kitchen mixer,
swivel spout 110°/150°/360°
#71280, -000

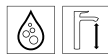

Logis®
Single lever kitchen mixer
for wall installation,
180° swivel spout
#71836, -000



Logis® 160
Single lever kitchen mixer
with 360° swivel spout
#71832, -000
#71833, -000 for installation in
front of a window (not shown)
#71834, -000 with shut-off valve
(not shown)
#71839, -000 CoolStart Eco
(not shown)



Logis® 120
Single lever kitchen mixer
with 360° swivel spout
#71830, -000
#71831, -000 for open water
heaters
#71837, -000 CoolStart Eco
(not shown)



Logis® Classic

NEW



Logis® Classic 200
2-handle kitchen mixer,
swivel spout, 110°/150°/360°
#71285, -000



Logis® Classic
2-handle kitchen mixer for wall
mounting, swivel spout 180°
#71286, -000



Logis® Classic
2-handle kitchen mixer
for wall mounting,
swivel spout 180°
#71287, -000



Hansgrohe kitchen technologies

Everything that makes excellent kitchen helpers

A kitchen helper should not only be an eye-catcher it should also withstand a lot. After all, a kitchen mixer is used up to ninety times a day. This makes it the most often used device in the kitchen. That is why we make every single

kitchen mixer exclusively from top quality materials – and fit them with technical highlights. This means: From the peeler to the gourmet, from the dishwasher to the five star chef – Hansgrohe kitchen mixers are a pleasure

to all. No matter who is turning on the tap: Here is where know-how quality, functionality and design come together. This makes our kitchen mixers competent helpers at the sink that will convince even the most discerning of customers.



Quality made by Hansgrohe: High quality materials and the fulfilment of international standards assure buyers that they are purchasing a long lasting quality product.



MagFit magnetic holder: Thanks to the MagFit function, the hose slides back almost silently and slots back into place in the middle of the mixer spout.



Pull-out spray with two spray types: The pull-out spray also offers two types of spray, normal and shower, which are easy to change between.



Ergonomic handles: Long flat handles for ease of control.



Swivel function: The mixers offer either a limited swivel range (110°/120°/150°) or all-round freedom of movement (360°).



Pull-out spray/spout: The pull-out spray and the pull-out spout extend the range at the sink.



ComfortZone: The ultra high spout offers plenty of space and is ideal for filling large containers and pots.



Select Button: Select technology ensures that using it is easy: a simple click is all it takes to stop and start the water flow. As easy as ABC with an elbow or the back of a hand – so the mixer stays clean.



Vertical handle position: Installation is possible even when there is only little room between the mixer and wall. Plus: Hot water flows at the vertical handle out of the reach of children's hands.



Separation of spout and control unit: The handle can be positioned flexibly, around the sink in the desired location.



Variable handle positioning: The handle can be installed on the left or right, as preferred.



Stainless steel look PVD: Stainless steel look surfaces are made with PVD technology and are particularly resistant to wear and scratches.



QuickClean: It is very difficult for limescale to take hold on the elastic disc and if it does, it can easily be rubbed away.



Fold-down function for window installation: Ideal for installation in front of a window; simply lift the mixer up when required and lay it down.



Ceramic or joystick cartridge with Boltic handle lock: Thanks to the specially hardened plastics, the joystick, M1 and M2 cartridges help to ensure the mixer has a long functional life. The wedge-shaped control lever of the Boltic handle prevents the handle wobbling in use.



PEX hoses: The PEX hoses are temperature-resistant and neutral in taste and odour.



Easy installation: Flexible connections and the integrated stabilisation plate for thin-walled stainless steel sinks make it easier to install the mixer, and guarantee safe results.



QuickConnect for pull-out spray hoses: Thanks to the QuickConnect function, the hoses are particularly easy to fit.



Kitchen shut-off valve: Available as an option in the same design as any Hansgrohe kitchen mixer for external device shut-off, such as dishwashers.



Five year guarantee: You can trust Hansgrohe quality. This is confirmed by the voluntary five-year warranty.

COMPANY

**Ideas with water:
Hansgrohe has been a step
ahead of its time since 1901**



The Hansgrohe company

The love of water lies in our family

Hans Grohe was a pioneer, constantly looking to create new innovations, he was not satisfied with anything less than groundbreaking. In a time when initial ideas were being aired for private home bathrooms and the daily shower was still utopian, he was already developing the first showerheads. He therefore set new standards in the bathroom – far beyond the borders of the Black Forest. Now with branches and subsidiaries in

44 countries on all continents and global product availability, the Hansgrohe brand is seen to be one of the few global players in the bathroom industry. Now as then, the family company is producing predominantly in Schiltach and Offenburg – an acknowledgement to “made in Germany” and at the same time an expression of the values lived at Hansgrohe. One of the most important values is that of social responsibility. The

Hansgrohe Group is therefore one of the sector’s pioneers in the arena of sustainability and environmental protection. This is reflected in water and energy saving products as well as in sophisticated recycling systems, environmentally friendly production technologies, global environmental protection projects and information on the sustainable handling of the resource water.



Hans Grohe was still young when he founded the company in 1901



Hans Grohe with his son Klaus, 1937



Klaus Grohe with his sons Richard and Philippe, 2013

Shower history at Hansgrohe

Milestones of shower technology

From the trickling apparatus to the convenient spray change at the push of a button: Since 1901, the inventions from the Black Forest thinktank have been shaping the

bathroom landscape all over the world. Many products, concepts and solutions developed and designed at Hansgrohe have given fresh impetus to the international bathroom industry.

Some have written bathroom, perhaps even cultural, history. Such a success story motivates us to constantly stay ahead of the times.



1928

First hand shower with white porcelain handle.

1968

Selecta®

Selecta hand shower with continuously adjustable shower spray and glass look.

1974

Tribel®

First design award winning hand shower in many colours and with three spray types.

1976

Mistral®

First hand shower with rotating massage spray.

1986

Aktiva®

First hand shower with anti-limescale function QuickClean.

1987

Mistral® Eco

New technology with up to 50% water savings.



1993
Joco®

First cartoon design hand shower for children.

1999
Aktiva® A8

2-shell hand shower with internal flow structure and threefold anti-limescale function.

2003
Raindance®

First hand shower with XL showerhead and Whirl spray.

2004
Raindance® Air

First hand shower with AirPower technology.

2009
PuraVida®

Pioneering design language with DualFinish in white/chrome; easy spray change at the push of a button.

2011
Raindance® Select

First Raindance hand shower with Select technology for spray changes

2012
Raindance® Select

First hand shower with two full rain sprays, changed by Select.

History of Hansgrohe mixers

Revolutions in mixer history

A Hansgrohe mixer is so much more than just a tap. It is always a piece of future for the bathroom. Hansgrohe added highlights in technology and form with its very first mixer, back in 1981. This was followed by numerous other innovations and inventions, and the company set standards in design and functionality – which is confirmed by numerous awards. Of course, this success is also a commitment. Which is why Hansgrohe does everything it can to introduce further epochs in the bathroom history. Hansgrohe has always stood for innovation.



1981
ALLEGROH

The first mixer with the new lever handle, swivel spout and innovative ball mix technique.

1985
Uno

First single lever mixers in red, white, grey and yellow – winners of several design awards.

1997
Boltic

Patented handle lock protects against handle wobbles – even after years.

2001
iBox® universal

First and only basic set for all standard and thermostat solutions – a revolution in concealed installation.

2002
Talis® S

The slender, sophisticated lines bring a new simplicity into the bathroom.



2005

World of Styles

2007

EcoSmart

2009

PuraVida®

2011

ComfortZone

2012

CoolStart

2015

Talis® Select

Two new style worlds: Elegance – circular, rounded and organic shapes. And Style – clear, minimal and flat.

New, environmentally friendly technology; Hansgrohe mixers only use 5 l/min as standard.

Pioneering design with DualFinish in white/chrome; international award winner thanks to the sculptural looks and technical features.

Various spout heights provide greater freedom of movement in the bathroom.

User-friendly, energy-saving technology where only cold water flows when the handle is in the central position.

First basin mixer with Select technology. Water is turned on and off at the touch of a button.



Award for outstanding design

Perfected water pleasure also means for us: Perfectly shaped

To us, design is not a matter of taste, but an attitude – even a passion. Accordingly, international acclaim has been a constant source of joy to us: Hansgrohe SE with its Hansgrohe and Axor brands took eleventh

place in the 2015 iF rankings and is therefore number one on the bathroom industry. Over 450 awards make us one of the highest award winners on the sanitary market. However, design is never an end in itself, but always an

expression of equality between form and function. In the search for the most intelligent solution, we create showers and mixers whose extraordinary quality is a never ending source of pleasure.



Raindance®
Hand shower



2003 2003 2004



Raindance® S 150
Hand shower



2005 2006 2006



Raindance® Royale 350
Overhead shower



2005 2005 2006



Raindance® Rainmaker®
Overhead shower



2005 2006



Metris® S
Electronic basin mixer



2006 2007



Focus® S
Single lever basin mixer



2006 2007



Raindance®
Hand shower



2007



Talis® E2
Single lever basin mixer



2007 2008



Croma® 100 Multi
Hand shower



2007 2008



Raindance® Rainfall® 240
Overhead shower



2007 2008 2009



Talis® S2
Single lever basin mixer



2007 2007 2008



Raindance® Connect S 240
Showerpipe



2007 2007 2008 2010



Croma® 100
Showerpipe



2008



Raindance® S 150 / Raindance® Unica® S
Set



2008 2009



Ecostat® E
Bath thermostat



2008 2009



Talis® Classic
Single lever basin mixer



2008 2009



Crometta® 85 Green
Hand shower



2008 2010



PuraVida® 240
Single lever basin mixer



2009 2009 2010 2011



PuraVida® 400
Overhead shower



2009 2010



PuraVida® 150
Hand shower



2009 2009 2010



PuraVida® 110
Single lever basin mixer



2009 2009 2010



RainBrain®
Shower control



2009 2012



Focus® E2
Single lever basin mixer



2010 2011



Raindance® E 420
Showerpipe



2010 2011 2013



reddot design award



Focus Open Silber 2012

DESIGN PLUS

powered by: **ISH**



Raindance® 240
Showerpipe



2010 2010 2011



Raindance® E 420
Overhead shower



2010 2012



PuraVida®
Electronic kitchen mixer



2011 2012



Raindance® Select S 150
Hand shower



2011 2012 2012



Raindance® Rainfall® 180
Overhead shower



2012



PuraVida®
Electronic basin mixer



2012



Focus® 240
Single lever basin mixer



2012



Focus®
Electronic basin mixer



2012 2012



PuraVida® 225
Single lever basin mixer



2012 2012



Metris®
Product family Single lever basin mixer

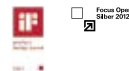

2012 2012



Talis®
Product family Single lever basin mixer



2012



Focus®
Product family Single lever basin mixer



2012



Raindance® Select E 120
Hand shower



2013



Raindance® Rainfall® Stream 150 1jet



2013



Raindance® Lift Showerpanel®



2013



ShowerSelect®
Thermostat product family



2013 2014 2014



ShowerTablet® Select 300
Thermostat



2013 2014



Raindance® Select S 120
Hand shower



2014



Metris® 320
Single lever kitchen mixer



2014



Logis®
Product family Single lever basin mixer



2014 2014



Metris® Select 320
Single lever kitchen mixer



2014



Talis® Select S
Product family Select basin mixer



2015 2015



Rainmaker® Select
Showerpipe



2015 2015



ShowerSelect® Glas
Thermostat product family



2015 2015



Crometta® 100
Product family hand shower



2015



Manfred Dorn, Tom Schönherr, Andreas Haug, and Harald Lutz (from left)

Winner of many awards: Phoenix design

This team has been shaping the face of Hansgrohe for many years: Andreas Haug, Tom Schönherr, Manfred Dorn and Harald Lutz. Their yardstick of successful design is the satisfaction of the people who use their products. Although this creative team prefer to work in the background, they are nevertheless overjoyed at the many awards their design workshop has received.

Photo: Phoenix Design

International projects

The world is our home



All over the world, developers and investors work hand in hand with architects and planners on sophisticated projects. They are constantly in need of intelligent and aesthetically appealing solutions for handling the essential element water. The mixers,

showers and bathroom collections from the Black Forest lend top addresses that definite extra design and comfort: in impressive hotels and public buildings, in private residences and royal palaces, in exclusive sports clubs and in cruise ships and luxury yachts. You will find

further inspiring examples of this on our innovative bathroom planning platform:

<http://pro.hansgrohe-int.com/references>



Hotel Vander Urbani Resort, Ljubljana
Hansgrohe products:
PuraVida® basin mixer 200, PuraVida® bath mixer,
PuraVida® baton shower

Photos: Miran Kambic



Unique Design Hotel Lone, Rovinj
Hansgrohe products:
Talis® basin mixer, Talis® bath mixer,
Croma® 100 hand shower

Photos: 3LHD



Hotel JW Marriott Santa Fe, Mexico City
 Hansgrohe products:
 PuraVida® basin mixer, PuraVida® bath mixer,
 PuraVida® baton shower

Photos: Hotel Marriott Santa Fe



Neue Hofgärten, Ludwigshafen
 Hansgrohe products:
 Metris® bath mixer, Croma® 100 Vario/
 Porter 'S set

Photos: Hansgrohe Esch



Hotel SS Hilton, Gdańsk
 Hansgrohe products:
 Talis® 80 basin mixer, Raindance® S 120 Air/
 Unica® 'S Puro shower set, EcoStat® S thermostat

Photos: Jan Wójcikiewicz

Stamford Residences, Sydney
Hansgrohe products:
Focus® 100 basin mixer, Focus® bath spout

Photos: Stuart Scott



Hotel Saint Regis, Roma
Hansgrohe products:
Raindance® E 420 Air Showerpipe,
Raindance® Classic 300 overhead shower,
Raindance® E 120 Air hand shower

Photo top: Matthias Hamel Fotografie
Photo left: Enrico Maria Santoni

Al Matrook Tower, Bahrain
 Hansgrohe products:
 Metris® 3-hole bath mixer for the tub rim

Photos: The Domain Bahrain



Private bathroom Christina Obergföll, world champion javelin throw 2013
 Hansgrohe products:
 ShowerSelect® finish sets, Raindance® Rainfall®,
 Raindance® Select E 120 hand shower, Metris®
 basin mixer, Metris® bath mixer

Photos: Peng Chen



Cruiselinier Norwegian Breakaway
 Hansgrohe products:
 Metris® basin mixer, Metris® 3-hole bath mixer,
 Raindance® S Showerpanel®

Photo top: Meyer Werft
 Photo left: Ingrid Fiebak-Kremer

Technologies



Switches over to a different shower or spray type in moments, and provides pleasure at the touch of a button.



Reduces the flow rate to save water and energy. For long-lasting pleasure.



Combines water with a generous amount of air. For a soft, splash-free water spray and rich, full shower drops.



Limescale deposits are simply wiped away by rubbing a finger over the flexible silicone jets.



Distributes the water over the large spray face envelops the whole body in drops of well-being.



Defines the useable area between washstand and mixer. Something to suit every customer.

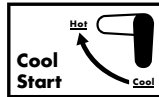

Cold water starts to flow when it is opened in the basic setting. You consume hot water only when you need it.

Spray modes



Rain spray over the entire area of the spray face for large-scale showering pleasure.



Perfect for rinsing shampoo out of your hair.

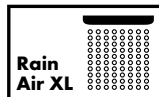

The especially large spray face envelops your whole body with soft drops.



Gentle shower rain with air-enriched drops.



The ultra-soft drops are a delight for the skin and soul.



An intensive water spray that activates and refreshes.



The most powerful of all Rain sprays – for a refreshingly powerful showering experience.

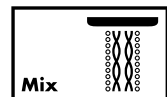

The harmonious combination of gentle shower drops and dynamic spray.

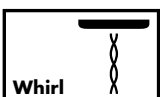

A concentrated massage spray.

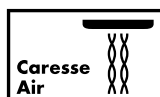

Provides fresh energy after a challenging day: The feel good, revitalising massage spray.



Strong, pulsating massage spray.



A flat, targeted jet for partly refreshing shower pleasure.



A powerful surge spray for the feeling of standing alone in a waterfall. Every day.



Parallel jets of large sparkling water drops right down to the floor for the same showering experience on all body sizes.

Surfaces

Order numbers specifying a surface finish are (#) eight digits long, for example 28500, -000=Chrome

-000 Chrome
-400 White/chrome
-450 White

-600 Black/chrome
-800 Stainless steel optic

Please bear in mind that we can present only a selection of our products in this sales manual. Our full range can be found at <http://pro.hansgrohe-int.com>.

Find out more about the Hansgrohe world at <http://pro.hansgrohe-int.com>



Experience Hansgrohe products interactively

The iPad version of the end customer catalogue can be found at <http://appstore.com/hansgroheshowroom>



Planning with Hansgrohe@home

Use this app to show your customers how good a Hansgrohe mixer will look in their home, virtually.

iTunes: <http://appstore.com/hansgrohehome>

Google Play: <http://play.google.com/store/search?q=hansgrohe+se>



Savings with Hansgrohe

All you need to know about how Hansgrohe helps to save water and energy can be found at www.hansgrohe-int.com/savings-calculator or, on mobile devices, at <http://m.pro.savings.hansgrohe-int.com>



This catalogue has been produced with as much care for the environment as possible. You can also do your bit for the environment by passing this catalogue on to others when you have finished with it or else recycling it.



www.facebook.com/hansgrohe



www.twitter.com/hansgrohe_pr



www.youtube.com/hansgrohe



Hansgrohe professional support:

The Hansgrohe Master Service

Experienced master sanitary fitters provide sound knowhow for your technical questions on any product in the Hansgrohe range. Service and spare parts are supplied over the fastest route.

Service hours:

Mon–Fri: 7:00 am to 06:00 pm
 Phone: +49 7836 51-1282
 Fax: +49 7836 51-1440
 Email: info@hansgrohe.com

Hansgrohe availability guarantee

All spare parts are available for ten years following purchase. You can then rest assured, also for projects completed in the past.

Hansgrohe quality warranty

The highest quality is an elementary constituent of the Hansgrohe corporate philosophy. For this reason, we offer consumers a voluntary manufacturer's warranty of five years on our products.

Details at www.hansgrohe-int.com.

Hansgrohe Aquademie

The Aquademie is our adventure centre on all aspects of water. Learn everything about bathroom and bathing history at our museum. Our exhibition shows you how international designers turn bathrooms into real feel good oases. See for yourself how innovative technologies put genuine pleasure into water savings. Or enjoy pure showering and water fun in our Showerworld, Germany's largest bathroom.

Opening hours:

Mon–Fri: 7:30 am to 07:00 pm
 Sat–Sun: 10:30 am to 04:00 pm
 Admission free of charge. For Showerworld: Appointment and swimwear required.

Headquarters – Hansgrohe SE · P.O. Box 1145 · D-77757 Schiltach · Tel. +49 7836 51-0
 Fax +49 7836 51-1300 · info@hansgrohe.com · www.hansgrohe-int.com

Argentina – Hansgrohe S.A. · Av. del Libertador 14.323 · Martínez · B1640APB · Buenos Aires
 Tel. +54 11 4733 2400 · Fax +54 11 4733 2499 · info@hansgrohe.com.ar · www.hansgrohe.com.ar

Australia – Hansgrohe Pty Ltd · Level 1 · 123 Camberwell Rd · East Hawthorn · Victoria 3123
 Tel. +61 3 9811 9971 · info@hansgrohe.com.au · www.hansgrohe.com.au

Central America & The Caribbean – Hansgrohe SE Regional Office
 Obarrio, 58 Street, PH Office One, No. 803 · Panama, Republic of Panama
 Tel. + 507 263 1343 · marketing.cca@hansgrohe.com

Denmark – Hansgrohe A/S · Jegstrupvej 6 · DK-8361 Hasselager · Tel. +45 86 287400
 Fax +45 86 287401 · info@hansgrohe.dk · www.hansgrohe.dk

Estonia – Hansgrohe Eesti esindaja Andrus Asavi · Maealuse 2/1 · 12618 Tallinn
 Tel. +372 53 32 92 55 · Fax +372 56 00 00 55 · info@hansgrohe.ee · www.hansgrohe.ee

Latvia – Hansgrohe Latvijas pārstāvniecība · SIA Aqua Studio · Raiņa iela 14 · LV-3913 Iecava
 Tel. +371 29 22 90 29 · Fax +371 63 94 22 51 · info@hansgrohe.lv · www.hansgrohe.lv

Lithuania – Santoza · Ulonų g. 5 · LT-08240 Vilnius · Tel. +370 5 2043291
 Fax +370 5 2043293 · info@hansgrohe.lt · www.hansgrohe.lt

Netherlands – Hansgrohe · Handelsweg 45 · 1525 RG Westknollendam
 Tel. +31 75 6461400 · info@hansgrohe.nl · www.hansgrohe.nl

Romania – Hansgrohe SE · P.O. Box 1145 · D-77757 Schiltach · Tel. +49 7836 51-0
 Fax +49 7836 51-1300 · info@hansgrohe.ro · www.hansgrohe.ro

Sweden – Hansgrohe AB · Svngatan 2B · S-416 68 Göteborg
 Tel. +46 31 216600 · Fax +46 31 190103 · info@hansgrohe.se · www.hansgrohe.se

