

**Singapore MWELS & VWELS
Compliant Mixers & Showers**

Version 8
(As of July 2015)

7/2015 • Printed in Singapore



Founded in Schiltach, Black Forest in 1901, Hansgrohe has 10 production locations across three continents and 37 subsidiaries around the world. With its showers, fittings and shower systems, Hansgrohe creates the original products that make the bathroom more functional, comfortable and beautiful. More than 360 international awards and innumerable technological innovations attest to this status. Our passion for water as the elixir of life will continue to be a source of inspiration.

In recent years, there is an increasing trend of sustainability awareness in the region and as one of the leading brands in the sanitary industry, Hansgrohe has developed a series of products that is catered to this cause.

MWELS and VWELS Information **02**

**MWELS Basin, Bath/Shower
and Kitchen Mixers with
1/2" Connection Nuts** **04**

**Other MWELS Compliant Basin,
Bath/Shower and Kitchen Mixers** **27**

VWELS Compliant Showers **174**

hansgrohe

Mandatory Water Efficiency Labelling Scheme (MWELS)

With effect from 1st July 2009, Singapore Public Utilities Board (PUB) has implemented the Mandatory Water Efficiency Labelling Scheme (MWELS) that is mandatory for all basin, shower and kitchen mixers except concealed types. The flow rate requirements of the water fittings are as follows:

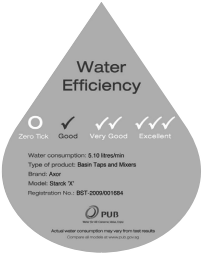
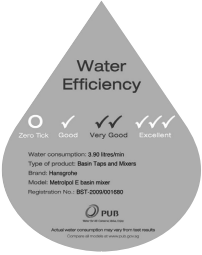
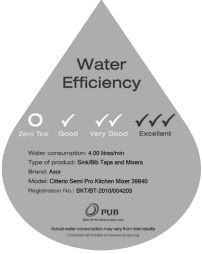
Example of MWELS Label	Product Fittings	Flow Rate
 <p>Water Efficiency</p> <p>Zero Tick Good Very Good Excellent</p> <p>Water consumption: 5.10 litres/min Type of product: Basin Taps and Mixers Brand: Auer Model: Shower 'X' Registration No.: BBT-2008001894</p> <p>PUB</p>	Shower Taps and Mixers	Pressure Range from 0.5 to 5.5 bar Zero Tick: > 9 litres/min Good (1 Tick): > 7 to 9 litres/min Very Good (2 Ticks): > 5 to 7 litres/min Excellent (3 Ticks): 5 litres/min or less (minimum flow rate requirements is 4.5 litres/min)
 <p>Water Efficiency</p> <p>Zero Tick Good Very Good Excellent</p> <p>Water consumption: 3.06 litres/min Type of product: Basin Taps and Mixers Brand: Hangrohe Model: Mergel E basin mixer Registration No.: BBT-2008001890</p> <p>PUB</p>	Basin Taps and Mixers	Pressure Range from 0.5 to 5.5 bar Zero Tick: > 6 litres/min Good (1 Tick): > 4 to 6 litres/min Very Good (2 Ticks): > 2 to 4 litres/min Excellent (3 Ticks): 2 litres/min or less (minimum flow rate requirements is 1.5 litres/min)
 <p>Water Efficiency</p> <p>Zero Tick Good Very Good Excellent</p> <p>Water consumption: 4.20 litres/min Type of product: Sink Taps and Mixers Brand: Auer Model: Citrus Semi Pro Kitchen Mixer 3090 Registration No.: BKT-BT-2010004220</p> <p>PUB</p>	Sink Taps and Mixers	Pressure Range from 0.5 to 5.5 bar Zero Tick: > 8 litres/min Good (1 Tick): > 6 to 8 litres/min Very Good (2 Ticks): > 4 to 6 litres/min Excellent (3 Ticks): 4 litres/min or less (minimum flow rate requirements is 2.5 litres/min)

Voluntary Water Efficiency Labelling Scheme (VWELS)

From 2006, Singapore Public Utilities Board (PUB) has implemented that all showers must be installed with a limiter to ensure that the flow rates from the showers do not exceed 9 litres/min. The flow rate requirements are as follows:

Example of VWELS Label	Product Fittings	Flow Rate
 <p>Water Efficiency</p> <p>Good Very Good Excellent</p> <p>Water consumption: 7.20 litres/min Type of product: Showers Brand: Hangrohe Model: Rurhede All-Overhead Shower 240 27477 Serial No.: 022012114927</p> <p>PUB</p>	Showers	Pressure Range from 1.5 to 5.0 bar Good (1 Tick): > 7 to 9 litres/min Very Good (2 Ticks): > 5 to 7 litres/min Excellent (3 Ticks): 5 litres/min or less

MWELS compliant basin mixers with 1/2" connection nuts

For the more popular series of Hansgrohe and Axor basin mixers, they are now available with distinct - 009 article numbers, versions that are compliant to PUB MWELS 1-tick specification. This version is also delivered with hexagon connection nuts that are more installation friendly. This not only saves time but also costs as it makes installation of the fittings easier. It also contributes towards the BCA Greenmark, which is a green building rating system to evaluate a building for its environmental impact and performance.

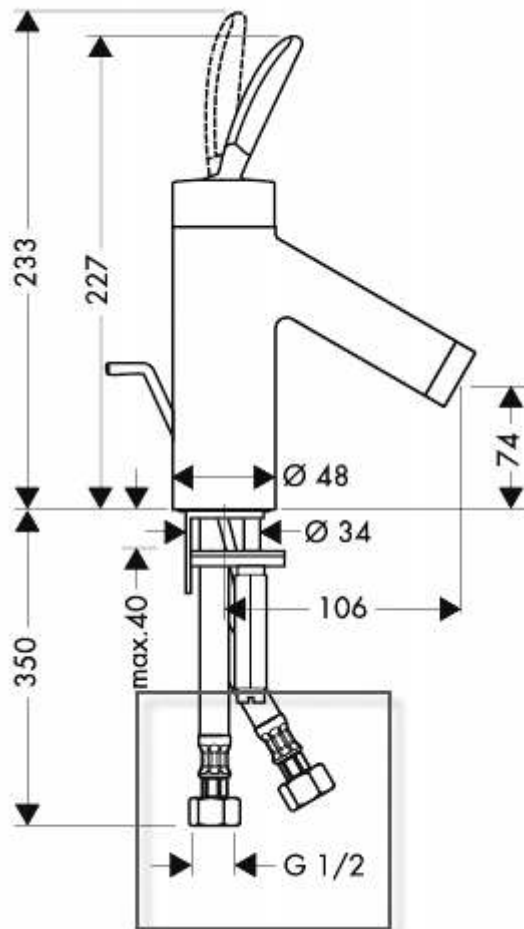

Depending on the product, customized versions that comply to PUB 2-ticks or 3-ticks specification may be available on request.

Hansgrohe 009 Approved Products

Type	Article No.	Descriptions	1 tick	2 ticks	3 ticks	Water Consumption
Kitchen Mixer	14870009	Talis S2 Kitchen Mixer	✓			7.30 litres/min
Kitchen Mixer	14870019	Talis S2 Kitchen Mixer		✓✓		4.80 litres/min
Kitchen Mixer	14872009	Talis S2 Kitchen Mixer	✓			7.20 litres/min
Kitchen Mixer	14877009	Talis S2 Kitchen Mixer	✓			6.70 litres/min
Basin Mixer	15070009	PuraVida Single Lever Basin Mixer	✓			4.26 litres/min
Basin Mixer	15072009	PuraVida Single Lever Basin Mixer	✓			4.14 litres/min
Showerpipe	27167009	Raindance Showerpipe 240mm	✓			8.70 litres/min
Showerpipe	27169009	Croma 100 Showerpipe	✓			8.30 litres/min
Basin Mixer	31022009	Metris S Single Lever Basin Mixer	✓			4.20 litres/min
Basin Mixer	31060009	Metris S Single Lever Basin Mixer	✓			4.50 litres/min
Basin Mixer	31080009	Metris Single Lever Basin Mixer	✓			5.00 litres/min
Basin Mixer	31082009	Metris Single Lever Basin Mixer	✓			5.10 litres/min
Bath Mixer	31480009	Metris Exposed Bath Mixer	✓			8.30 litres/min
Basin Mixer	31607009	Focus Single Lever Basin Mixer	✓			4.90 litres/min
Basin Mixer	31607009	Focus Single Lever Basin Mixer	✓			5.00 litres/min
Basin Mixer	31607019	Focus Single Lever Basin Mixer		✓✓		3.00 litres/min
Basin Mixer	31607029	Focus Single Lever Basin Mixer			✓✓✓	2.00 litres/min
Basin Mixer	31612009	Talis E2 Single Lever Basin Mixer	✓			4.20 litres/min
Bath Mixer	31642009	Talis E2 Exposed Bath Mixer	✓			7.48 litres/min
Shower Mixer	31660009	Metris S Exposed Shower Mixer	✓			7.40 litres/min
Shower Mixer	31662009	Talis E2 Exposed Shower Mixer	✓			8.30 litres/min
Shower Mixer	31680009	Metris Exposed Shower Mixer	✓			8.10 litres/min
Basin Mixer	31730009	Focus Single Lever Basin Mixer	✓			4.50 litres/min
Basin Mixer	31730019	Focus Single Lever Basin Mixer		✓✓		3.10 litres/min
Basin Mixer	31730029	Focus Single Lever Basin Mixer			✓✓✓	1.70 litres/min
Bath Mixer	31742009	Focus S Exposed Bath Mixer	✓			7.60 litres/min
Shower Mixer	31762009	Focus S Exposed Shower Mixer	✓			7.40 litres/min
Kitchen Mixer	31786009	Focus S Kitchen Mixer	✓			6.90 litres/min
Kitchen Mixer	31786019	Focus Kitchen Mixer		✓✓		4.90 litres/min
Kitchen Mixer	31806019	Focus Kitchen Mixer		✓✓		4.90 litres/min
Kitchen Mixer	31817009	Focus Kitchen Mixer	✓			7.70 litres/min
Kitchen Mixer	31820009	Focus Kitchen Mixer	✓			7.40 litres/min
Bath Mixer	31940009	Focus E2 Exposed Bath Mixer	✓			8.30 litres/min
Shower Mixer	31960009	Focus E2 Exposed Shower Mixer	✓			8.20 litres/min
Basin Mixer	32040009	Talis S Single Lever Basin Mixer	✓			4.20 litres/min
Basin Mixer	71070009	Logis Single Lever Basin Mixer	✓			4.80 litres/min
Basin Mixer	71070019	Logis Single Lever Basin Mixer		✓✓		3.40 litres/min
Basin Mixer	71070029	Logis Single Lever Basin Mixer			✓✓✓	1.70 litres/min
Basin Mixer	71100009	Logis Single Lever Basin Mixer	✓			5.10 litres/min
Basin Mixer	71100019	Logis Single Lever Basin Mixer		✓✓		3.20 litres/min
Basin Mixer	71100029	Logis Single Lever Basin Mixer			✓✓✓	1.60 litres/min
Bath Mixer	71400009	Logis Exposed Bath Mixer	✓			7.80 litres/min
Shower Mixer	71600009	Logis Exposed Shower Mixer	✓			7.90 litres/min

Axor 009 Approved Products

Type	Article No.	Descriptions	1 tick	2 ticks	3 ticks	Water Consumption
Basin Mixer	11020009	Axor Urquiola Single Lever Basin Mixer	✓			4.40 litres/min
Basin Mixer	18020009	Axor Massaud Basin Mixer	✓			4.24 litres/min
Basin Mixer	39010009	Axor Citterio Basin Mixer	✓			4.40 litres/min
Showerpipe	39620009	Axor Citterio Showerpipe	✓			8.10 litres/min

Basin

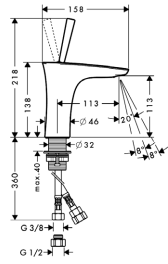

Single Lever Basin Mixer DN15

- joystick cartridge
- adjustable spray former
- push-open waste set 1 1/4"
- PEX hoses with 1/2" connecting nut
- suitable for continuous flow water heaters
- quality mark under application
- dirt filter inside hoses
- MWELS 1 tick

Code No. 15070009
15070409
Colour pure chrome
white chrome



✓ Good
Water Consumption: 4.26 litres/min
Type of Product: Basin Taps and Mixers
Brand: Hansgrohe
Model: Pura Vida Single Lever Basin Mixer 15070
Reg no.: BST-2009/003425

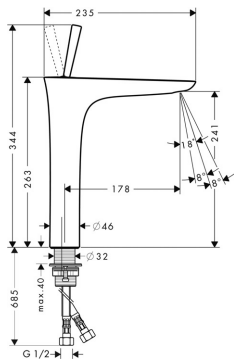

Single Lever Basin Mixer DN15 for wash bowls

- joystick cartridge
- adjustable spray former
- push-open waste set 1 1/4"
- PEX hoses with 1/2" connecting nut
- suitable for continuous flow water heaters
- quality mark under application
- dirt filter inside hoses
- MWELS 1 tick

Code No. 15072009
15072409
Colour pure chrome
white chrome



✓ Good
Water Consumption: 4.14 litres/min
Type of Product: Basin Taps and Mixers
Brand: Hansgrohe
Model: Pura Vida Highriser Basin Mixer 15072
Reg no.: BST-2009/003427

Basin

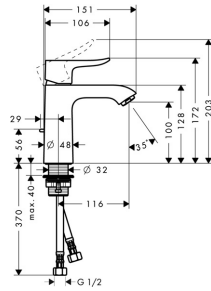
**Single Lever Basin Mixer 110 DN15**

- ComfortZone 110mm
- ceramic cartridge
- Boltic lever lock
- adjustable temperature restriction
- QuickClean aerator
- pop-up waste set G 1¹/₄"
- suitable for continuous flow water heaters
- quality mark under application
- MWELS 1 tick

Code No. 31080009**Colour** chrome

✓ Good

Water Consumption: 5.00 litres/min

Type of Product: Basin Taps and Mixers

Brand: Hansgrohe

Model: Metris Single Lever Basin Mixer 110mm 31080

Reg no.: BST-2011/007451

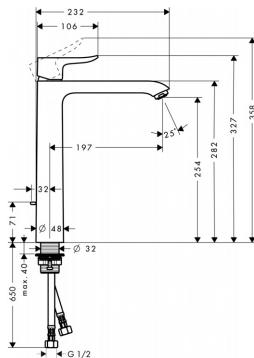
**Single Lever Basin Mixer 260 DN15
for wash bowls**

- ComfortZone 260mm
- ceramic cartridge
- Boltic lever lock
- adjustable temperature restriction
- QuickClean aerator
- pop-up waste set G 1¹/₄"
- suitable for continuous flow water heaters
- quality mark under application
- MWELS 1 tick

Code No. 31082009**Colour** chrome

✓ Good

Water Consumption: 5.10 litres/min

Type of Product: Basin Taps and Mixers

Brand: Hansgrohe

Model: Metris Single Lever Basin Mixer 260mm 31082

Reg no.: BST-2011/007453

Bath

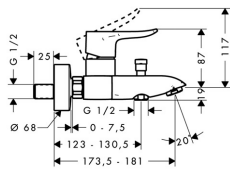

Single Lever Bath Mixer DN15 for exposed fitting

- ceramic cartridge
- Boltic lever lock
- non-return valve
- adjustable temperature restriction
- QuickClean aerator
- button with stop/diverter valve to revert from shower to bath filler
- centre distance 150± 12mm
- S-shaped connections with noise reduction
- quality mark under application
- MWELS 1 tick

Code No. 31480009

Colour chrome



✓ Good

Water Consumption: 8.30 litres/min

Type of Product: Shower Taps and Mixers

Brand: Hansgrohe

Model: Metris Exposed Bath Mixer 31480009

Reg no.: SHT-2011/007497

Shower

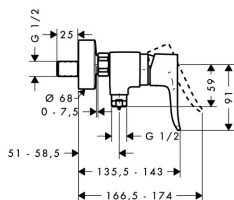

Single Lever Shower Mixer DN15 for exposed fitting

- ceramic cartridge
- Boltic lever lock
- non-return valve
- adjustable temperature restriction
- centre distance 150± 12mm
- S-shaped connections with noise reduction
- quality mark under application
- MWELS 1 tick

Code No. 31680009

Colour chrome



✓ Good

Water Consumption: 8.10 litres/min

Type of Product: Shower Taps and Mixers

Brand: Hansgrohe

Model: Metris Exposed Shower Mixer 31680009

Reg no.: SHT-2011/007454

Basin

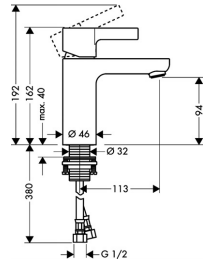

Single Lever Basin Mixer DN15

- ceramic cartridge
- Boltic lever lock
- adjustable temperature restriction
- QuickClean aerator
- pop-up waste set 1 1/4"
- suitable for continuous flow water heaters
- MWELS 1 tick

Code No. 31060009

Colour chrome



✓ Good

Water Consumption: 4.50 litres/min

Type of Product: Basin Taps and Mixers

Brand: Hansgrohe

Model: Metris S Single Lever Basin Mixer 31060

Reg no.: BST-2010/004515

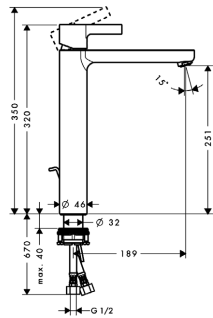

Metris S DN15 for wash bowls

- ceramic cartridge
- Boltic lever lock
- adjustable temperature restriction
- QuickClean aerator
- pop-up waste set 1 1/4"
- suitable for continuous flow water heaters
- MWELS 1 tick

Code No. 31022009

Colour chrome



✓ Good

Water Consumption: 4.20 litres/min

Type of Product: Basin Taps and Mixers

Brand: Hansgrohe

Model: Metris 'S' (Highriser)

Reg no.: BST-2009/001302

Shower

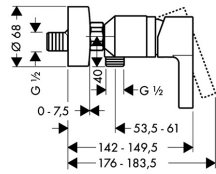

Single Lever Shower Mixer DN15 for exposed fitting

- ceramic cartridge
- Boltic lever lock
- non-return valve
- adjustable temperature regulation
- centre distance 150 ± 12 mm
- S-shaped connections with noise reduction
- MWELS 1 tick

Code No. 31660009

Colour chrome



✓ Good

Water Consumption: 7.40 litres/min

Type of Product: Shower Taps and Mixers

Brand: Hansgrohe

Model: Metris S Exposed Shower Mixer 31660009

Reg no.: SHT-2010/005916

Basin

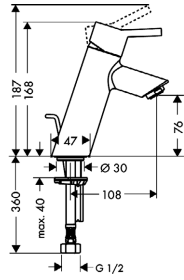
**Single Lever Basin Mixer DN15**

- ceramic cartridge
- Boltic lever lock
- adjustable temperature restriction
- QuickClean aerator
- pop-up waste set 1 1/4"
- suitable for continuous flow water heaters
- MWELS 1 tick

Code No. 32040009

Colour chrome



✓ Good

Water Consumption: 4.20 litres/min

Type of Product: Basin Taps and Mixers

Brand: Hansgrohe

Model: Talis 'S' 2

Reg no.: BST-2009/001681

Basin

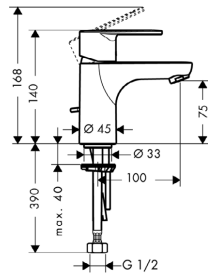

Single Lever Basin Mixer DN15

- ceramic cartridge
- Boltic lever lock
- adjustable temperature restriction
- QuickClean aerator
- pop-up waste set 1 1/4"
- suitable for continuous flow water heaters
- MWELS 1 tick

Code No. 31612009

Colour chrome



✓ Good
 Water Consumption: 4.20 litres/min
 Type of Product: Basin Taps and Mixers
 Brand: Hansgrohe
 Model: Talis E2 Single Lever Basin Mixer 31612
 Reg no.: BST-2009/003437

Bath

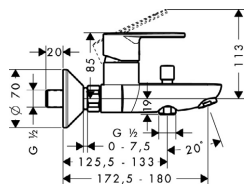
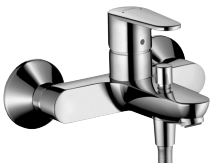

Single Lever Bath Mixer DN15

- ceramic cartridge
- Boltic lever lock
- non-return valve
- adjustable temperature restriction
- QuickClean aerator
- button with stop/diverter valve to revert from shower to bath filler
- centre distance 150± 12mm
- S-shaped connections with noise reduction
- MWELS 1 tick

Code No. 31642009

Colour chrome



✓ Good
 Water Consumption: 7.48 litres/min
 Type of Product: Shower Taps and Mixers
 Brand: Hansgrohe
 Model: Talis E2 exposed bath mixer
 Reg no.: SHT-2009/001650

Shower

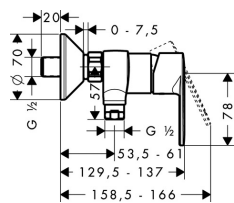

Single Lever Shower Mixer DN15 for exposed fitting

- ceramic cartridge
- Boltic lever lock
- non-return valve
- adjustable temperature regulation
- centre distance 150± 12mm
- S-shaped connections with noise reduction
- MWELS 1 tick

Code No. 31662009

Colour chrome



✓ Good
 Water Consumption: 7.53 litres/min
 Type of Product: Shower Taps and Mixers
 Brand: Hansgrohe
 Model: Talis E2 exposed shower mixer
 Reg no.: SHT-2009

Basin

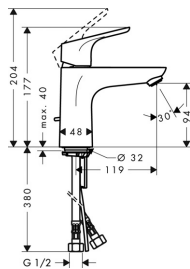

Single Lever Basin Mixer 100, DN15

- ComfortZone 100
- pop-up waste set G 1 1/4"
- ceramic cartridge
- Boltic lever lock
- adjustable temperature restriction
- QuickClean aerator
- suitable for continuous flow water heaters
- MWELS 1 tick, 2 ticks & 3 ticks

Code No. 31607009
31607019
31607029
Colour chrome



✓ Good
Water Consumption: 5.00 litres/min
Type of Product: Basin Taps and Mixers
Brand: Hansgrohe
Model: 31607009
Reg no.: BST-2014/014841



✓✓ Very Good
Water Consumption: 3.00 litres/min
Type of Product: Basin Taps and Mixers
Brand: Hansgrohe
Model: 31607019
Reg no.: BST-2014/014842



✓✓✓ Excellent
Water Consumption: 2.00 litres/min
Type of Product: Basin Taps and Mixers
Brand: Hansgrohe
Model: 31607029
Reg no.: BST-2014/015059

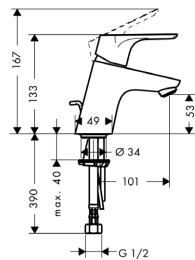

Single Lever Basin Mixer DN15

- ceramic cartridge
- Boltic lever lock
- adjustable temperature restriction
- QuickClean aerator
- pop-up waste set 1 1/4"
- suitable for continuous flow water heaters
- MWELS 2 ticks & 3 ticks

Code No. 31730019
31730029
Colour chrome



✓✓ Very Good
Water Consumption: 3.10 litres/min
Type of Product: Basin Taps and Mixers
Brand: Hansgrohe
Model: Focus 31730019
Reg no.: BST-2014/016187



✓✓✓ Excellent
Water Consumption: 1.70 litres/min
Type of Product: Basin Taps and Mixers
Brand: Hansgrohe
Model: Focus 31730029
Reg no.: BST-2014/016195

Bath

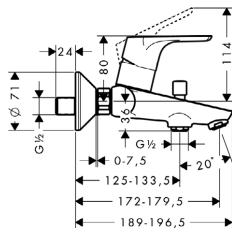

Single Lever Bath Mixer DN15 for exposed fitting

- ceramic cartridge
- Boltic lever lock
- non-return valve, QuickClean aerator
- adjustable temperature restriction
- button with stop/diverter valve to revert from shower to bath filler
- centre distance 150± 12mm
- S-shaped connections with noise reduction
- MWELS 1 tick

Code No. 31940009
Colour chrome



✓ Good
Water Consumption: 8.30 litres/min
Type of Product: Shower Taps and Mixers
Brand: Hansgrohe
Model: Focus E2 Exposed Bath Mixer 31940009
Reg no.: SHT-2011/006937

Shower

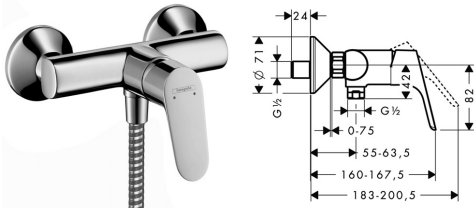

Single Lever Shower Mixer DN15 for exposed fitting

- ceramic cartridge
- Boltic lever lock
- adjustable temperature restriction
- centre distance 150 ± 12 mm
- S-shaped connections with noise reduction
- MWELS 1 tick

Code No. 31960009

Colour chrome



✓ Good

Water Consumption: 7.37 litres/min

Type of Product: Shower Taps and Mixers

Brand: Hansgrohe

Model: Focus E2 exposed shower mixer

Reg no.: SHT-2009/001547

Basin

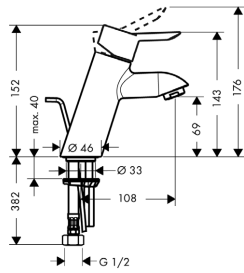

Single Lever Basin Mixer DN15

- ceramic cartridge
- Boltic lever lock
- adjustable temperature restriction
- QuickClean aerator
- pop-up waste set 1 1/4"
- suitable for continuous flow water heaters
- MWELS 1 tick

Code No. 31701009

Colour chrome



✓ Good
 Water Consumption: 4.50 litres/min
 Type of Product: Basin Taps and Mixers
 Brand: Hansgrohe
 Model: Focus S single lever basin mixer
 Reg no.: BST-2009/001714

Bath

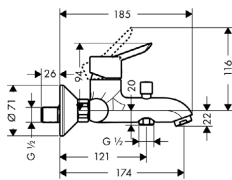
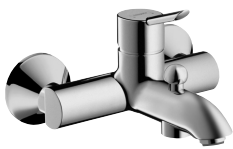

Single Lever Bath Mixer DN15 for exposed fitting

- ceramic cartridge
- Boltic lever lock
- non-return valve
- adjustable temperature restriction
- QuickClean aerator
- button with stop/diverter valve to revert from shower to bath filler
- centre distance 150± 12mm
- S-shaped connections with noise reduction
- MWELS 1 tick

Code No. 31742009

Colour chrome



✓ Good
 Water Consumption: 7.60 litres/min
 Type of Product: Shower Taps and Mixers
 Brand: Hansgrohe
 Model: Focus S Exposed Bath Mixer 31742009
 Reg no.: SHT-2010/005943

Shower

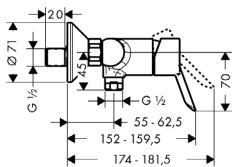
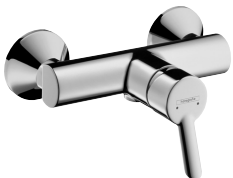

Single Lever Shower Mixer DN15 for exposed fitting

- ceramic cartridge
- Boltic lever lock
- adjustable temperature regulation
- non-return valve
- centre distance 150± 12mm
- S-shaped connections with noise reduction
- MWELS 1 tick

Code No. 31762009

Colour chrome



✓ Good
 Water Consumption: 7.40 litres/min
 Type of Product: Shower Taps and Mixers
 Brand: Hansgrohe
 Model: Focus S Exposed Shower Mixer 31762009
 Reg no.: SHT-2010/005949

Basin

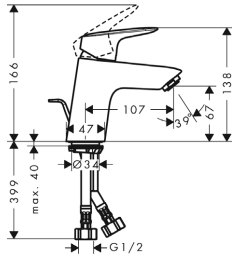

Single Lever Basin Mixer 70 with pop-up waste set

- ComfortZone 70
- normal spray
- ceramic cartridge
- temperature limitation adjustable
- pop-up waste set G 1 1/4"
- suitable for continuous flow water heaters
- connection dimension: DN15
- MWELS 1 tick, 2 ticks & 3 ticks

Code No. 71070009
71070019
71070029
Colour chrome



✓ Good
Water Consumption: 4.80 litres/min
Type of Product: Basin Taps and Mixers
Brand: Hansgrohe
Model: 71070009
Reg no.: BST-2014/014473



✓✓ Very Good
Water Consumption: 3.40 litres/min
Type of Product: Basin Taps and Mixers
Brand: Hansgrohe
Model: 71070019
Reg no.: BST-2014/014474



✓✓✓ Excellent
Water Consumption: 1.70 litres/min
Type of Product: Basin Taps and Mixers
Brand: Hansgrohe
Model: 71070029
Reg no.: BST-2014/015054

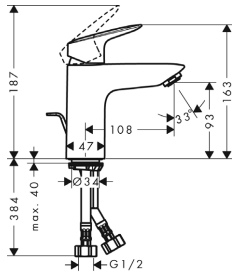

Single Lever Basin Mixer 100 with pop-up waste set

- ComfortZone 100
- normal spray
- ceramic cartridge
- temperature limitation adjustable
- pop-up waste set G 1 1/4"
- suitable for continuous flow water heaters
- connection dimension: DN15
- MWELS 1 tick, 2 ticks & 3 ticks

Code No. 71100009
71100019
71100029
Colour chrome



✓ Good
Water Consumption: 5.10 litres/min
Type of Product: Basin Taps and Mixers
Brand: Hansgrohe
Model: 71100009
Reg no.: BST-2014/014475



✓✓ Very Good
Water Consumption: 3.20 litres/min
Type of Product: Basin Taps and Mixers
Brand: Hansgrohe
Model: 71100019
Reg no.: BST-2014/014476



✓✓✓ Excellent
Water Consumption: 1.60 litres/min
Type of Product: Basin Taps and Mixers
Brand: Hansgrohe
Model: 71100029
Reg no.: BST-2014/015055

Bath

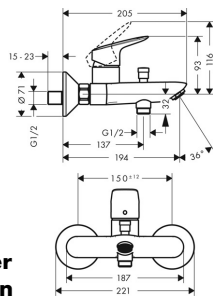

Single Lever Bath Mixer for exposed installation

- connection type: s-shpaed connections
- centre distance 150mm ± 12mm
- normal spray
- ceramic cartridge
- temperature limitation adjustable
- with automatic resetting
- non-return valve
- with silencer
- suitable for continuous flow water heaters
- connection dimensions: DN15
- MWELS 1 tick

Code No. 71400009
Colour chrome



✓ Good
Water Consumption: 7.80 litres/min
Type of Product: Shower Taps and Mixers
Brand: Hansgrohe
Model: 71400009
Reg no.: SHT-2014/014477

Shower

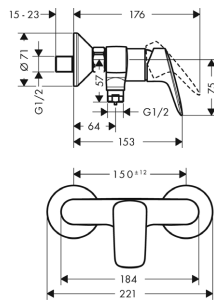

Single Lever Shower Mixer for exposed installation

- connection type: s-shaped connections
- centre distance 150mm ± 12mm
- ceramic cartridge
- temperature limitation adjustable
- non-return valve
- with silencer
- hose connection DN15
- connection dimensions: DN15
- MWELS 1 tick

Code No. 71600009

Colour chrome



✓ Good

Water Consumption: 7.90 litres/min

Type of Product: Shower Taps and Mixers

Brand: Hansgrohe

Model: 71600009

Reg no.: SHT-2014/014478

Showerpipe

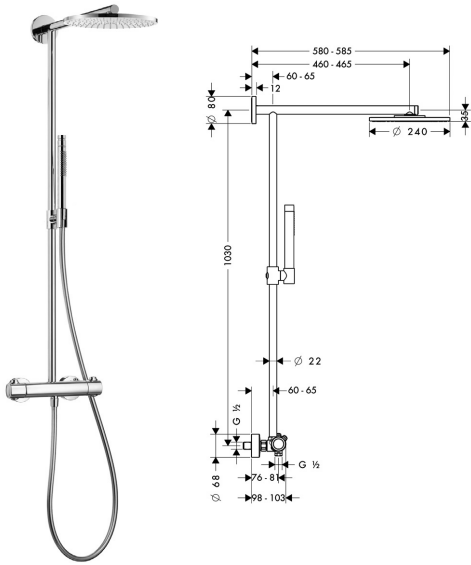

Code No. 27167009
Colour chrome

Raindance Showerpipe 240mm shower arm 460mm, DN 15

consisting of:

- thermostat for exposed fitting with shut-off/diverter valve
- Raindance AIR overhead shower Ø240mm with AirPower technology and QuickClean anti-limescale system
- centre distance 150± 12mm
- hand shower with 2 spray modes:
Normal spray and soft spray (no.28532000)
- Isiflex shower hose 1.60m DN15 (no.28276000)
- height adjustable metal shower holder
- including 7mm wall bar spacer (no.98681000)
- suitable for continuous flow water heaters, if the flow pressure at the mixer is a minimum of 0.15MPa
- PA-IX 18465/IIOB
- MWELS 1 tick



✓ Good

Water Consumption: 8.70 litres/min

Type of Product: Shower Taps and Mixers

Brand: Hansgrohe

Model: Raindance Showerpipe 240mm 27167009

Reg no.: SHT-2010/006682

Showerpipe

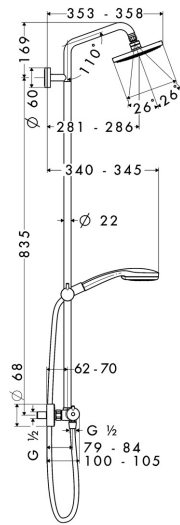

Code No. 27169009

Colour chrome

Croma 100 Showerpipe, DN15

consisting of:

- Ecostat S thermostat for exposed installation with shut-off/diverter valve
- centre distance 150 ± 12mm
- Croma 160 overhead shower Ø160mm (no.27450000)
- QuickClean anti-limescale system
- Croma 100 Vario hand shower (no.28535000),
- Isiflex shower hose 1.60m, DN15 (no.28276000)
- height adjustable shower holder
- including 7mm wall bar spacer (no.95239000)
- MWELS 1 tick



✓ Good

Water Consumption: 8.30 litres/min

Type of Product: Shower Taps and Mixers

Brand: Hansgrohe

Model: Croma 100 Showerpipe 27169009

Reg no.: SHT-2010/006681

Basin

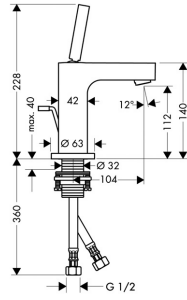

Single Lever Basin Mixer DN15

- joystick cartridge
- QuickClean aerator
- pop-up waste set 1 1/4"
- suitable for continuous flow water heaters
- P-IX 9508/1A
- MWELS 1 tick

Code No. 39010009

Colour chrome



✓ Good
 Water Consumption: 4.40 litres/min
 Type of Product: Basin Taps and Mixers
 Brand: Axor
 Model: Citterio Single lever basin mixer
 Reg no.: BST-2009/001703

Showerpipe

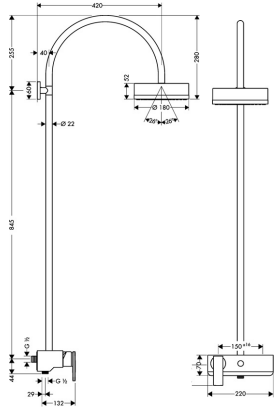

Showerpipe DN15

- consisting of:
- single lever mixer for wall mounting with diverter
 - overhead shower
 - hand shower
 - shower hose 1.60m
 - shower support
 - QuickClean system
 - centre distance 150± 16mm
 - MWELS 1 tick

Comment: height dimension from platform 1200mm

Code No. 39620009

Colour chrome



✓ Good
 Water Consumption: 8.10 litres/min
 Type of Product: Shower Taps and Mixers
 Brand: Axor
 Model: Citterio Showerpipe 39620009
 Reg no.: SHT-2010/005913

Basin

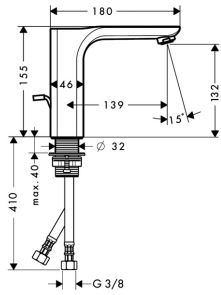

Single Lever Basin Mixer DN15

- ceramic cartridge
- QuickClean anti-limescale system
- pop-up waste set 1 1/4"
- suitable for continuous flow water heaters
- adjustable temperature restriction
- MWELS 1 tick

Code No. 11020009

Colour chrome



✓ Good

Water Consumption: 4.40 litres/min

Type of Product: Basin Taps and Mixers

Brand: Axor

Model: Urquiola Single Lever Basin Mixer 11020

Reg no.: BST-2009/003268

Basin

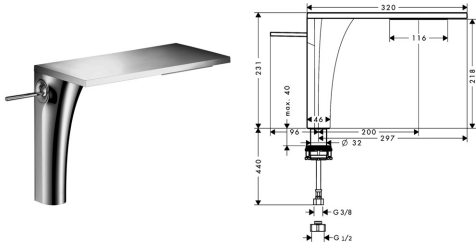

Single Lever Basin Mixer DN15 for wash bowls

- wide flood jet
- joystick cartridge
- flush grated waste
- suitable for continuous flow water heaters
- MWELS 1 tick

Code No. 18020009

Colour chrome



✓ Good

Water Consumption: 4.24 litres/min

Type of Product: Basin Taps and Mixers

Brand: Axor

Model: Massaud Highriser single lever 18020

Reg no.: BST-2009/001683

Talis S² Variarc

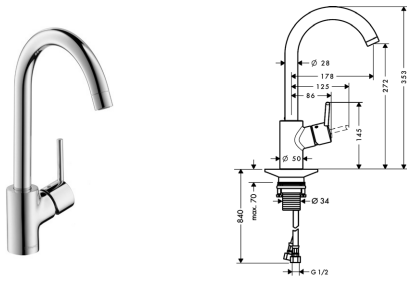

Single Lever Kitchen Mixer DN15

- QuickClean anti-limescale system
- ceramic cartridge
- Boltic lever lock
- swivel spout (adjustable in 3 steps)
- MWELS 1 tick & 2 ticks

Code No. 14870009
14870019
Colour chrome



✓ **Good**
Water Consumption: 7.30 litres/min
Type of Product: Sink/Bib Taps and Mixers
Brand: Hansgrohe
Model: Talis S Variarc Kitchen Mixer 14870
Reg no.: SKT/BT-2009/002929



✓✓ **Very Good**
Water Consumption: 4.80 litres/min
Type of Product: Sink/Bib Taps and Mixers
Brand: Hansgrohe
Model: Talis S² Variarc Kitchen Mixer 14870019
Reg no.: SKT/BT-2014/016181

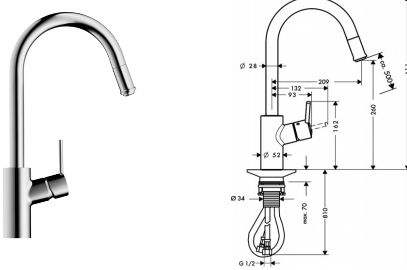

Single Lever Kitchen Mixer DN15 with pull-out spout

- QuickClean anti-limescale system
- ceramic cartridge
- Boltic lever lock
- swivel spout 150°
- Normal spray
- suitable for mounting in front of a window, can be laid flat
- non-return valve, magnetic shower support
- MWELS 1 tick

Code No. 14872009
Colour chrome



✓ **Good**
Water Consumption: 7.20 litres/min
Type of Product: Sink/Bib Taps and Mixers
Brand: Hansgrohe
Model: Talis S Variarc Kitchen Mixer Pull Out 14872
Reg no.: SKT/BT-2010/004538

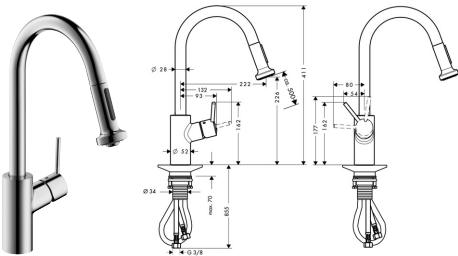

Single Lever Kitchen Mixer DN15 with pull-out spray

- QuickClean anti-limescale system
- ceramic cartridge
- Boltic lever lock
- swivel spout 150°
- Normal and spray jet (non-arresting)
- suitable for mounting in front of a window, can be laid flat
- non-return valve, magnetic shower support
- MWELS 1 tick

Code No. 14877009
Colour chrome



✓ **Good**
Water Consumption: 6.70 litres/min
Type of Product: Sink/Bib Taps and Mixers
Brand: Hansgrohe
Model: Variarc Kitchen Mixer With Pull Out/Spray 14877
Reg no.: SKT/BT-2009/003752

Focus

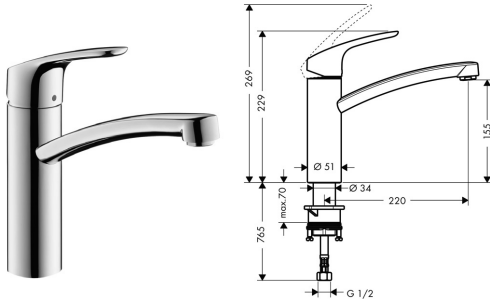

Single Lever Kitchen Mixer

- swivel range 360°
- normal spray
- connection dimension: DN15
- ceramic cartridge
- connection type: G 1/2 connections
- suitable for continuous flow water heaters
- MWELS 2 ticks

Code No. 31806019
31806819
Colour chrome
stainless steel optic



✓✓ Very Good
Water Consumption: 4.90 litres/min
Type of Product: Sink/Bib Taps and Mixers
Brand: Hansgrohe
Model: Focus 31806019
Reg no.: SKT/BT-2014/016186

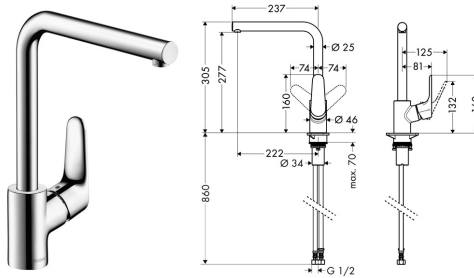

Single Lever Kitchen Mixer with swivel spout

- l-spout
- swivel range adjustable in 3 steps 110°, 150° or 360°
- handle can be positioned on the right or left
- laminar spray
- connection dimension: DN15
- ceramic cartridge
- connection type: G 1/2 connections
- suitable for continuous flow water heaters
- MWELS 1 tick

Code No. 31817009
31817809
Colour chrome
stainless steel optic



✓ Good
Water Consumption: 7.70 litres/min
Type of Product: Sink/Bib Taps and Mixers
Brand: Hansgrohe
Model: Focus 31817009
Reg no.: SKT/BT-2014/016185

Focus

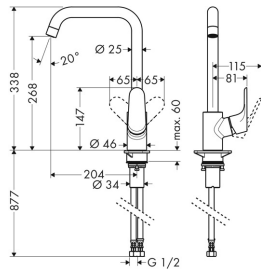

Single Lever Kitchen Mixer

- swivel range adjustable in 3 steps 110°, 150° or 360°
- handle can be positioned on the right or left
- normal spray
- connection dimension: DN15
- ceramic cartridge
- connection type: G 1/2 connections
- suitable for continuous flow water heaters
- MWELS 1 tick

Code No. 31820009
31820809
Colour chrome
stainless steel optic



✓ Good
Water Consumption: 7.40 litres/min
Type of Product: Sink/Bib Taps and Mixers
Brand: Hansgrohe
Model: Focus 31820009
Reg no.: SKT/BT-2014/016184

Focus S

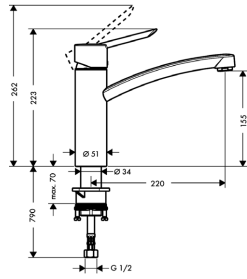

Single Lever Kitchen Mixer DN15

- QuickClean system
- ceramic cartridge
- Boltic lever lock
- swivel spout 360°
- MWELS 1 tick

Code No. 31786009

Colour chrome



✓ Good

Water Consumption: 6.90 litres/min

Type of Product: Sink/Bib Taps and Mixers

Brand: Hansgrohe

Model: Focus S Single Lever Kitchen Mixer 31786

Reg no.: SKT/BT-2009/003750

Other MWELS compliant Basin, Bath/Shower and Kitchen Mixers

The following products are also available in MWELS compliant versions. However the basin mixers are delivered with the standard $\frac{3}{8}$ " connection nut. The list is accurate at the time of print. Please enquire for the latest current MWELS compliant product list.

hansgrohe

Hansgrohe MWELS Approved Products

Type	Article No.	Descriptions	1 tick	2 ticks	3 ticks	Water Consumption
Ecostat Select	13123	Ecostat Exposed Thermostat	✓			7.60 litres/min
Ecostat Select	13123E	Ecostat Exposed Thermostat		✓✓		6.40 litres/min
Ecostat Select	13141	Ecostat Select Thermostatic Bath Mixer	✓			7.30 litres/min
Ecostat Select	13141E	Ecostat Select Thermostatic Bath Mixer		✓✓		6.30 litres/min
ShowerTablet	13151	ShowerTablet Select 300 Thermostatic Bath Mixer	✓			7.30 litres/min
ShowerTablet	13151E	ShowerTablet Select 300 Thermostatic Bath Mixer		✓✓		6.70 litres/min
ShowerTablet	13151L	ShowerTablet Select 300 Thermostatic Bath Mixer			✓✓✓	4.70 litres/min
ShowerTablet	13171	ShowerTablet Select 300 Thermostatic Shower Mixer	✓			7.20 litres/min
ShowerTablet	13171E	ShowerTablet Select 300 Thermostatic Shower Mixer		✓✓		6.60 litres/min
Bath Mixer	13241	Ecostat 1001SL Thermostatic Bath Mixer	✓			7.56 litres/min
Shower Mixer	13261	Ecostat 1001SL Thermostatic Shower Mixer	✓			7.20 litres/min
Shower Mixer	13261E	Ecostat 1001SL Thermostatic Shower Mixer		✓✓		6.40 litres/min
Basin Mixer	14020	Metropol S Basin Mixer	✓			4.40 litres/min
Basin Mixer	14063	Metropol S Three Hole Basin Mixer	✓			4.40 litres/min
Basin Mixer	14111	Talis Classic Single Lever Basin Mixer	✓			4.30 litres/min
Basin Mixer	14113	Talis Classic Three Hole Basin Mixer	✓			5.30 litres/min
Basin Mixer	14113E	Talis Classic Three Hole Basin Mixer		✓✓		3.10 litres/min
Basin Mixer	14116	Talis Classic Single Lever Basin Mixer	✓			4.20 litres/min
Basin Mixer	14127	Talis Classic Natural Basin Mixer	✓			4.60 litres/min
Bath Mixer	14140	Talis Classic Exposed Bath Mixer	✓			7.30 litres/min
Shower Mixer	14161	Talis Classic Exposed Shower Mixer	✓			7.03 litres/min
Basin Mixer	14180	Status 2 Single lever Basin Mixer	✓			5.30 litres/min
Bath Mixer	14184	Status 2 Exposed Bath Mixer	✓			8.10 litres/min
Shower Mixer	14186	Status 2 Exposed Shower Mixer	✓			8.00 litres/min
Bath Mixer	14461	Metropol S Exposed Bath Mixer	✓			7.25 litres/min
Bath Mixer	14470	Metropol E Exposed Bath Mixer	✓			7.32 litres/min
Shower Mixer	14661	Metropol S Exposed Shower Mixer	✓			7.25 litres/min
Shower Mixer	14670	Metropol E Exposed Shower Mixer	✓			7.46 litres/min
Kitchen Mixer	14820	Metris Kitchen Mixer	✓			7.70 litres/min
Kitchen Mixer	14820E	Metris Kitchen Mixer		✓✓		4.70 litres/min
Kitchen Mixer	14820L	Metris Kitchen Mixer			✓✓✓	2.70 litres/min
Kitchen Mixer	14821	Metris Kitchen Mixer	✓			7.40 litres/min
Kitchen Mixer	14821E	Metris Kitchen Mixer		✓✓		4.70 litres/min
Kitchen Mixer	14821L	Metris Kitchen Mixer			✓✓✓	2.90 litres/min
Kitchen Mixer	14822	Metris Kitchen Mixer	✓			7.40 litres/min
Kitchen Mixer	14822E	Metris Kitchen Mixer		✓✓		4.70 litres/min
Kitchen Mixer	14822L	Metris Kitchen Mixer			✓✓✓	3.10 litres/min
Kitchen Mixer	14870	Talis S2 Kitchen Mixer	✓			7.30 litres/min
Kitchen Mixer	14870E	Talis S2 Kitchen Mixer		✓✓		4.60 litres/min
Kitchen Mixer	14872	Talis S2 Kitchen Mixer	✓			7.20 litres/min
Kitchen Mixer	14872E	Talis S2 Variarc Kitchen Mixer		✓✓		4.40 litres/min
Kitchen Mixer	14877	Talis S2 Variarc Kitchen Mixer	✓			6.70 litres/min
Kitchen Mixer	14877E	Talis S2 Variarc Kitchen Mixer		✓✓		4.30 litres/min
Kitchen Mixer	14883E	Metris Select Kitchen Mixer		✓✓		4.60 litres/min
Basin Mixer	15070	PuraVida Single Lever Basin Mixer	✓			4.26 litres/min
Basin Mixer	15070E	PuraVida Single Lever Basin Mixer		✓✓		2.90 litres/min
Basin Mixer	15070L	PuraVida Single Lever Basin Mixer			✓✓✓	1.60 litres/min
Basin Mixer	15072	PuraVida Single Lever Basin Mixer	✓			4.14 litres/min

Hansgrohe MWELS Approved Products

Type	Article No.	Descriptions	1 tick	2 ticks	3 ticks	Water Consumption
Basin Mixer	15072E	PuraVida Single Lever Basin Mixer		✓✓		3.10 litres/min
Basin Mixer	15072L	PuraVida Single Lever Basin Mixer			✓✓✓	1.70 litres/min
Basin Mixer	15073	Pura Vida Three Hole Basin Mixer	✓			4.40 litres/min
Basin Mixer	15074E	PuraVida Single Lever Basin Mixer		✓✓		3.30 litres/min
Basin Mixer	15075	PuraVida Single Lever Basin Mixer	✓			4.30 litres/min
Basin Mixer	15081	PuraVida Single Lever Basin Mixer	✓			4.50 litres/min
Basin Mixer	15081E	PuraVida Single Lever Basin Mixer		✓✓		3.10 litres/min
Basin Mixer	15084	PuraVida Wall-Mounted Basin Mixer	✓			4.50 litres/min
Basin Mixer	15084E	PuraVida Wall-Mounted Basin Mixer		✓✓		3.00 litres/min
Basin Mixer	15085	PuraVida Wall-Mounted Basin Mixer	✓			5.00 litres/min
Basin Mixer	15085E	PuraVida Wall-Mounted Basin Mixer		✓✓		2.90 litres/min
Bath Mixer	15472	PuraVida Exposed Bath Mixer	✓			7.60 litres/min
Bath Mixer	15472E	PuraVida Exposed Bath Mixer		✓✓		6.20 litres/min
Bath Mixer	15473	PuraVida Free Standing Bath Mixer	✓			7.30 litres/min
Shower Mixer	15672	PuraVida Exposed Shower Mixer	✓			7.50 litres/min
Shower Panel	26870	Pharo Lift 2 Panel		✓✓		6.60 litres/min
Shower Panel	27008	Raindance Lift Shower Panel	✓			8.10 litres/min
Showerpipe	27112	Raindance Select E360	✓			7.80 litres/min
Showerpipe	27114	Raindance Select S300	✓			8.30 litres/min
Showerpipe	27115	Raindance Select S240	✓			8.40 litres/min
Showerpipe	27117	Raindance Select S240 for Bath Tub	✓			8.70 litres/min
Showerpipe	27126	Raindance Select E300 2 Jet	✓			7.10 litres/min
Showerpipe	27127	Raindance Select E300 3 Jet	✓			8.50 litres/min
Showerpipe	27128	Raindance Select E300 2 Jet	✓			7.90 litres/min
Showerpipe	27129	Raindance Select 240	✓			7.50 litres/min
Showerpipe	27135	Croma 160 with Single Lever Mixer	✓			7.40 litres/min
Showerpipe	27143	Croma 100 with Single Lever Mixer	✓			7.30 litres/min
Showerpipe	27154	Croma 100 with Single Lever Mixer	✓			8.90 litres/min
Showerpipe	27185	Croma 220 with Thermostat	✓			8.00 litres/min
Showerpipe	27222	Croma 220 with Single Lever Mixer	✓			8.50 litres/min
Basin Mixer	31022	Metris S Highriser Basin Mixer	✓			4.20 litres/min
Basin Mixer	31022E	Metris S Highriser Basin Mixer		✓✓		2.90 litres/min
Basin Mixer	31022L	Metris S Highriser Basin Mixer			✓✓✓	2.00 litres/min
Basin Mixer	31023	Metris S Single Lever Basin Mixer	✓			4.70 litres/min
Basin Mixer	31023E	Metris S Single Lever Basin Mixer		✓✓		3.00 litres/min
Basin Mixer	31060	Metris S Single Lever Basin Mixer	✓			4.50 litres/min
Basin Mixer	31060E	Metris S single Lever Basin Mixer		✓✓		3.20 litres/min
Basin Mixer	31060L	Metris S single Lever Basin Mixer			✓✓✓	1.80 litres/min
Basin Mixer	31070	Metris E Single Lever Basin Mixer	✓			4.60 litres/min
Basin Mixer	31075	Metris Classic Single Lever Basin Mixer	✓			4.30 litres/min
Basin Mixer	31078	Metris Classic Highriser Basin Mixer	✓			4.20 litres/min
Basin Mixer	31080	Metris Single Lever Basin Mixer	✓			5.00 litres/min
Basin Mixer	31080E	Metris Single Lever Basin Mixer		✓✓		3.10 litres/min
Basin Mixer	31080L	Metris Single Lever Basin Mixer			✓✓✓	1.60 litres/min
Basin Mixer	31081	Metris Single Lever Basin Mixer	✓			5.10 litres/min
Basin Mixer	31082	Metris Single Lever Basin Mixer	✓			5.10 litres/min
Basin Mixer	31082E	Metris Single Lever Basin Mixer		✓✓		3.00 litres/min
Basin Mixer	31082L	Metris Single Lever Basin Mixer			✓✓✓	1.80 litres/min

Hansgrohe MWELS Approved Products

Type	Article No.	Descriptions	1 tick	2 ticks	3 ticks	Water Consumption
Basin Mixer	31083	Metris Three Hole Basin Mixer	✓			5.40 litres/min
Basin Mixer	31083E	Metris Three Hole Basin Mixer		✓✓		3.10 litres/min
Basin Mixer	31083L	Metris Three Hole Basin Mixer			✓✓✓	1.60 litres/min
Basin Mixer	31085	Metris Wall-Mounted Basin Mixer	✓			5.10 litres/min
Basin Mixer	31085E	Metris Wall-Mounted Basin Mixer		✓✓		3.20 litres/min
Basin Mixer	31085L	Metris Wall-Mounted Basin Mixer			✓✓✓	1.70 litres/min
Basin Mixer	31086	Metris Wall-Mounted Basin Mixer	✓			5.40 litres/min
Basin Mixer	31086E	Metris Wall-Mounted Basin Mixer		✓✓		2.80 litres/min
Basin Mixer	31086L	Metris Wall-Mounted Basin Mixer			✓✓✓	1.60 litres/min
Basin Mixer	31087	Metris Single Lever Basin Mixer	✓			4.80 litres/min
Basin Mixer	31088	Metris Single Lever Basin Mixer	✓			5.30 litres/min
Basin Mixer	31162	Metris S Wall-Mounted Basin Mixer	✓			5.40 litres/min
Basin Mixer	31163	Metris S Wall-Mounted Basin Mixer	✓			5.50 litres/min
Basin Mixer	31163E	Metris S Wall-Mounted Basin Mixer		✓✓		3.00 litres/min
Basin Mixer	31163L	Metris S Wall-Mounted Basin Mixer			✓✓✓	1.70 litres/min
Basin Mixer	31183	Metris Single Lever Basin Mixer	✓			5.50 litres/min
Basin Mixer	31185	Metris Single Lever Basin Mixer	✓			4.40 litres/min
Basin Mixer	31185E	Metris Single Lever Basin Mixer		✓✓		2.30 litres/min
Bath Mixer	31460	Metris S Exposed Bath Mixer	✓			7.61 litres/min
Bath Mixer	31460L	Metris S Exposed Bath Mixer			✓✓✓	4.80 litres/min
Bath Mixer	31470	Metris E Exposed Bath Mixer	✓			7.35 litres/min
Bath Mixer	31478	Metris Classic Exposed Bath Mixer	✓			8.00 litres/min
Bath Mixer	31480E	Metris Exposed Bath Mixer		✓✓		5.20 litres/min
Bath Mixer	31480L	Metris Exposed Bath Mixer			✓✓✓	4.60 litres/min
Basin Mixer	31518	Focus Single Lever Basin Mixer	✓			5.10 litres/min
Basin Mixer	31518E	Focus Single Lever Basin Mixer		✓✓		3.00 litres/min
Basin Mixer	31534L	Talis E2 Eco Exposed Bath Mixer			✓✓✓	4.60 litres/min
Basin Mixer	31607E	Focus Single Lever Basin Mixer		✓✓		2.90 litres/min
Basin Mixer	31607L	Focus Single Lever Basin Mixer			✓✓✓	1.60 litres/min
Basin Mixer	31608	Focus Single Lever Basin Mixer	✓			4.90 litres/min
Basin Mixer	31608E	Focus Single Lever Basin Mixer		✓✓		3.00 litres/min
Basin Mixer	31608L	Focus Single Lever Basin Mixer			✓✓✓	1.90 litres/min
Basin Mixer	31611	Talis Wall-Mounted Basin Mixer	✓			4.50 litres/min
Basin Mixer	31612	Talis E2 Single Lever Basin Mixer	✓			4.20 litres/min
Basin Mixer	31612E	Talis E2 Single Lever Basin Mixer		✓✓		3.00 litres/min
Basin Mixer	31612L	Talis E2 Single Lever Basin Mixer			✓✓✓	1.70 litres/min
Bath Mixer	31642	Talis E2 Exposed Bath Mixer	✓			7.50 litres/min
Bath Mixer	31642E	Talis E2 Exposed Bath Mixer		✓✓		6.40 litres/min
Bath Mixer	31642L	Talis E2 Exposed Bath Mixer			✓✓✓	4.80 litres/min
Shower Mixer	31660	Metris S Exposed Shower Mixer	✓			7.40 litres/min
Shower Mixer	31660E	Metris S Exposed Shower Mixer		✓✓		5.30 litres/min
Shower Mixer	31660L	Metris S Exposed Shower Mixer			✓✓✓	4.60 litres/min
Shower Mixer	31662	Talis E2 Exposed Shower Mixer	✓			7.53 litres/min
Shower Mixer	31662E	Talis E2 Exposed Shower Mixer		✓✓		6.60 litres/min
Shower Mixer	31662L	Talis E2 Exposed Shower Mixer			✓✓✓	4.70 litres/min
Shower Mixer	31670	Metris E Exposed Shower Mixer	✓			7.48 litres/min
Shower Mixer	31672	Metris Classic Exposed Shower Mixer	✓			7.50 litres/min
Shower Mixer	31672E	Metris Classic Exposed Shower Mixer		✓✓		6.50 litres/min

Hansgrohe MWELS Approved Products

Type	Article No.	Descriptions	1 tick	2 ticks	3 ticks	Water Consumption
Basin Mixer	31700	Focus E Single Lever Basin Mixer	✓			4.30 litres/min
Basin Mixer	31700E	Focus E Single Lever Basin Mixer		✓✓		3.10 litres/min
Basin Mixer	31700L	Focus E Single Lever Basin Mixer			✓✓✓	1.90 litres/min
Basin Mixer	31701	Focus S Single Lever Basin Mixer	✓			4.50 litres/min
Basin Mixer	31701E	Focus S Single Lever Basin Mixer		✓✓		3.50 litres/min
Basin Mixer	31710	Focus S Single Lever Basin Mixer	✓			4.80 litres/min
Basin Mixer	31730	Focus Single Lever Basin Mixer	✓			4.50 litres/min
Basin Mixer	31730EM	Focus Single Lever Basin Mixer (Mono)		✓✓		3.60 litres/min
Basin Mixer	31730ES	Focus Single Lever Basin Mixer (Spray)		✓✓		2.70 litres/min
Basin Mixer	31730L	Focus Single Lever Basin Mixer			✓✓✓	1.50 litres/min
Basin Mixer	31733	Focus Single Lever Basin Mixer	✓			4.60 litres/min
Basin Mixer	31733E	Focus Single Lever Basin Mixer		✓✓		3.00 litres/min
Basin Mixer	31733L	Focus E Single Lever Basin Mixer			✓✓✓	1.70 litres/min
Bath Mixer	31740	Focus E Exposed Bath Mixer	✓			8.07 litres/min
Bath Mixer	31740E	Focus E Exposed Bath Mixer		✓✓		5.00 litres/min
Bath Mixer	31742	Focus S Exposed Bath Mixer	✓			7.31 litres/min
Shower Mixer	31760	Focus E Exposed Shower Mixer	✓			7.74 litres/min
Shower Mixer	31760E	Focus E Exposed Shower Mixer		✓✓		6.70 litres/min
Shower Mixer	31760L	Focus E Exposed Shower Mixer			✓✓✓	4.90 litres/min
Shower Mixer	31762	Focus S Exposed Shower Mixer	✓			7.41 litres/min
Shower Mixer	31762E	Focus S Exposed Shower Mixer		✓✓		6.70 litres/min
Kitchen Mixer	31780	Focus E Kitchen Mixer	✓			7.10 litres/min
Kitchen Mixer	31780E	Focus E Kitchen Mixer		✓✓		4.50 litres/min
Kitchen Mixer	31786	Focus S Kitchen Mixer	✓			6.90 litres/min
Kitchen Mixer	31786E	Focus S Kitchen Mixer		✓✓		4.50 litres/min
Kitchen Mixer	31806	Focus Single Lever Kitchen Mixer	✓			7.30 litres/min
Kitchen Mixer	31806E	Focus E2 Kitchen Mixer		✓✓		4.80 litres/min
Kitchen Mixer	31806L	Focus E2 Kitchen Mixer			✓✓✓	3.20 litres/min
Kitchen Mixer	31815	Focus Kitchen Mixer	✓			7.40 litres/min
Kitchen Mixer	31815E	Focus Kitchen Mixer		✓✓		4.70 litres/min
Kitchen Mixer	31815L	Focus Kitchen Mixer			✓✓✓	2.90 litres/min
Kitchen Mixer	31817	Focus Kitchen Mixer	✓			7.70 litres/min
Kitchen Mixer	31817E	Focus Kitchen Mixer		✓✓		5.20 litres/min
Kitchen Mixer	31817L	Focus Kitchen Mixer			✓✓✓	3.60 litres/min
Kitchen Mixer	31820	Focus Kitchen Mixer	✓			7.90 litres/min
Kitchen Mixer	31820E	Focus Kitchen Mixer		✓✓		4.40 litres/min
Basin Mixer	31913	Focus Care Exposed Bath Mixer	✓			4.40 litres/min
Basin Mixer	31913E	Focus Care Exposed Bath Mixer		✓✓		2.40 litres/min
Shower Mixer	31916	Focus Care Exposed Shower Mixer	✓			7.30 litres/min
Shower Mixer	31916E	Focus Care Exposed Shower Mixer		✓✓		5.30 litres/min
Bath Mixer	31940	Focus Exposed Bath Mixer	✓			7.86 litres/min
Bath Mixer	31940L	Focus Single Bath Mixer			✓✓✓	5.00 litres/min
Shower Mixer	31960	Focus E2 Exposed Shower Mixer	✓			7.37 litres/min
Basin Mixer	32020	Talis S Single Lever Basin Mixer	✓			4.50 litres/min
Basin Mixer	32020E	Talis S Single Lever Basin Mixer		✓✓		3.70 litres/min
Basin Mixer	32034	Talis Single Lever Basin Mixer	✓			4.20 litres/min
Basin Mixer	32036	Talis Care Basin Mixer	✓			4.80 litres/min
Basin Mixer	32036E	Talis Care Basin Mixer		✓✓		2.90 litres/min

Hansgrohe MWELS Approved Products

Type	Article No.	Descriptions	1 tick	2 ticks	3 ticks	Water Consumption
Basin Mixer	32040	Talis Single Lever Basin Mixer	✓			4.20 litres/min
Basin Mixer	32040E	Talis Single Lever Basin Mixer		✓✓		3.10 litres/min
Basin Mixer	32040L	Talis Single Lever Basin Mixer			✓✓✓	1.70 litres/min
Basin Mixer	32052	Talis Single Lever Basin Mixer	✓			4.70 litres/min
Basin Mixer	32052E	Talis Single Lever Basin Mixer		✓✓		3.10 litres/min
Kitchen Mixer	32053	Talis Single Lever Basin Mixer	✓			4.70 litres/min
Kitchen Mixer	32053E	Talis Single Lever Basin Mixer		✓✓		3.20 litres/min
Basin Mixer	32055	Talis Single Lever Basin Mixer	✓			4.50 litres/min
Basin Mixer	32055E	Talis Single Lever Basin Mixer		✓✓		2.90 litres/min
Basin Mixer	32070	Talis S Single Lever Basin Mixer	✓			4.30 litres/min
Basin Mixer	32080	Talis Single Lever Basin Mixer	✓			4.80 litres/min
Basin Mixer	32080E	Talis Single Lever Basin Mixer		✓✓		3.20 litres/min
Bath Mixer	32420	Talis S Exposed Bath Mixer	✓			7.40 litres/min
Bath Mixer	32440	Talis S Exposed Bath Mixer	✓			7.50 litres/min
Bath Mixer	32441	Talis Care Exposed Bath Mixer	✓			8.60 litres/min
Bath Mixer	32441E	Talis Care Exposed Bath Mixer		✓✓		6.70 litres/min
Shower Mixer	32620	Talis S Exposed Shower Mixer	✓			7.70 litres/min
Shower Mixer	32620E	Talis S Exposed Shower Mixer		✓✓		6.20 litres/min
Shower Mixer	32640	Talis Exposed Shower Mixer	✓			7.34 litres/min
Kitchen Mixer	32841E	Talis S Kitchen Mixer		✓✓		4.10 litres/min
Kitchen Mixer	32851	Talis S Kitchen Mixer	✓			6.90 litres/min
Basin Mixer	71070	Logis Single Lever Basin Mixer	✓			4.80 litres/min
Basin Mixer	71070E	Logis Single Lever Basin Mixer		✓✓		3.40 litres/min
Basin Mixer	71090	Logis Single Lever Basin Mixer	✓			5.80 litres/min
Basin Mixer	71090E	Logis Single Lever Basin Mixer		✓✓		2.40 litres/min
Basin Mixer	71091	Logis Single Lever Basin Mixer	✓			4.20 litres/min
Basin Mixer	71091E	Logis Single Lever Basin Mixer		✓✓		2.20 litres/min
Basin Mixer	71100E	Logis Single Lever Basin Mixer		✓✓		3.20 litres/min
Basin Mixer	71101	Logis Single Lever Basin Mixer	✓			4.30 litres/min
Basin Mixer	71101E	Logis Single Lever Basin Mixer		✓✓		2.20 litres/min
Basin Mixer	71120	Logis Pillar Top	✓			4.40 litres/min
Basin Mixer	71120E	Logis Pillar Top		✓✓		2.40 litres/min
Basin Mixer	71130	Logis Single Lever Basin Mixer	✓			4.80 litres/min
Basin Mixer	71130E	Logis Single Lever Basin Mixer		✓✓		3.30 litres/min
Basin Mixer	71133	Logis Three Hole Basin Mixer	✓			5.80 litres/min
Basin Mixer	71133E	Logis Three Hole Basin Mixer		✓✓		3.20 litres/min
Basin Mixer	71133L	Logis Three Hole Basin Mixer			✓✓✓	1.70 litres/min
Basin Mixer	71323	Logis Classic Three Hole Basin Mixer	✓			4.50 litres/min
Basin Mixer	71323E	Logis Classic Three Hole Basin Mixer		✓✓		2.50 litres/min
Bath Mixer	71400E	Logis Exposed Bath Mixer		✓✓		6.50 litres/min
Basin Mixer	71600E	Logis Exposed Shower Mixer		✓✓		5.60 litres/min

Axor MWELS Approved Products

Type	Article No.	Descriptions	1 tick	2 ticks	3 ticks	Water Consumption
Basin Mixer	10010	Axor Starck Classic Basin Mixer	✓			4.30 litres/min
Basin Mixer	10015	Axor Starck Classic Basin Mixer	✓			4.80 litres/min
Basin Mixer	10015E	Axor Starck Classic Basin Mixer		✓✓		2.90 litres/min
Basin Mixer	10020	Axor Starck Classic Highriser Basin Mixer	✓			4.90 litres/min
Basin Mixer	10020E	Axor Starck Classic Highriser Basin Mixer		✓✓		2.90 litres/min
Basin Mixer	10030	Axor Starck Two Handle Basin Mixer	✓			4.70 litres/min
Basin Mixer	10058	Axor Starck Two Handle Highriser Basin Mixer	✓			4.60 litres/min
Basin Mixer	10070	Axor Starck X Basin Mixer	✓			5.10 litres/min
Basin Mixer	10070E	Axor Starck X Single Lever Basin Mixer		✓✓		3.10 litres/min
Basin Mixer	10071	Axor Starck X Basin Mixer	✓			4.10 litres/min
Basin Mixer	10074	Axor Starck Wall Mounted Basin Mixer	✓			5.20 litres/min
Basin Mixer	10074E	Axor Starck Wall Mounted Basin Mixer	✓			3.50 litres/min
Basin Mixer	10077E	Axor Starck X Single Lever Basin Mixer		✓✓		3.00 litres/min
Basin Mixer	10080	Axor Starck X Basin Mixer	✓			4.50 litres/min
Basin Mixer	10084	Axor Starck X Basin Mixer	✓			4.90 litres/min
Basin Mixer	10111	Axor Starck Basin Mixer	✓			4.50 litres/min
Basin Mixer	10111	Axor Starck Basin Mixer	✓			5.20 litres/min
Basin Mixer	10111E	Axor Starck Basin Mixer		✓✓		3.10 litres/min
Basin Mixer	10117	Axor Starck Basin Mixer	✓			4.50 litres/min
Basin Mixer	10120	Axor Starck Highriser Basin Mixer	✓			4.30 litres/min
Basin Mixer	10123	Axor Starck Basin Mixer	✓			4.60 litres/min
Basin Mixer	10123E	Axor Starck Basin Mixer		✓✓		2.80 litres/min
Basin Mixer	10129	Axor Starck Basin Mixer	✓			4.70 litres/min
Basin Mixer	10129E	Axor Starck Basin Mixer		✓✓		3.00 litres/min
Bath Mixer	10402	Axor Starck X Exposed Bath Mixer	✓			7.40 litres/min
Bath Mixer	10406	Axor Starck X Free-Standing Bath Mixer	✓			7.50 litres/min
Bath Mixer	10411	Axor Starck Floor-Standing Exposed Bath Mixer	✓			8.00 litres/min
Bath Mixer	10456	Axor Starck Floor-Standing Exposed Bath Mixer	✓			7.70 litres/min
Bath Mixer	10456E	Axor Starck Free-Standing Bath Mixer		✓✓		6.40 litres/min
Bath Mixer	10458	Axor Starck 2 Handle Free-Standing bath Mixer	✓			7.90 litres/min
Shower Mixer	10611	Axor Starck Exposed Shower Mixer	✓			7.50 litres/min
Kitchen Mixer	10801	Axor Starck Kitchen Mixer	✓			7.70 litres/min
Kitchen Mixer	10820E	Axor Starck Semi Pro Kitchen Mixer		✓✓		4.40 litres/min
Kitchen Mixer	10821	Axor Starck Kitchen Mixer	✓			6.20 litres/min
Kitchen Mixer	10821E	Axor Starck Kitchen Mixer		✓✓		4.70 litres/min
Kitchen Mixer	10822	Axor Starck Kitchen Mixer	✓			7.90 litres/min
Kitchen Mixer	10822E	Axor Starck Kitchen Mixer		✓✓		4.60 litres/min
Basin Mixer	11020	Axor Urquiola Single Lever Basin Mixer	✓			4.40 litres/min
Basin Mixer	11020E	Axor Urquiola Single Lever Basin Mixer		✓✓		2.80 litres/min
Basin Mixer	11023	Axor Urquiola Highriser Basin Mixer	✓			4.40 litres/min
Basin Mixer	11026	Axor Urquiola Wall Mounted Basin Mixer	✓			4.70 litres/min
Basin Mixer	11026E	Axor Urquiola Wall Mounted Basin Mixer		✓✓		2.90 litres/min
Basin Mixer	11026L	Axor Urquiola Wall Mounted Basin Mixer			✓✓✓	1.70 litres/min
Basin Mixer	11034	Axor Urquiola Single Lever Basin Mixer	✓			5.10 litres/min
Basin Mixer	11034E	Axor Urquiola Single Lever Basin Mixer		✓✓		3.00 litres/min
Basin Mixer	11034L	Axor Urquiola Single Lever Basin Mixer			✓✓✓	1.60 litres/min
Basin Mixer	11035E	Axor Urquiola Single Lever Basin Mixer		✓✓		3.20 litres/min

Axor MWELS Approved Products

Type	Article No.	Descriptions	1 tick	2 ticks	3 ticks	Water Consumption
Basin Mixer	11035L	Axor Urquiola Single Lever Basin Mixer			✓✓✓	1.60 litres/min
Basin Mixer	11040	Axor Urquiola Three Hole Basin Mixer with Plate	✓			5.10 litres/min
Basin Mixer	11041	Axor Urquiola Three Hole Basin Mixer with Escutcheon	✓			5.10 litres/min
Basin Mixer	11043	Axor Urquiola Three Hole Wall-Mounted Basin Mixer	✓			4.70 litres/min
Bath Mixer	11420	Axor Urquiola Exposed Bath Mixer	✓			7.70 litres/min
Bath Mixer	11422	Axor Urquiola Floor-Standing Bath Mixer	✓			7.60 litres/min
Basin Mixer	11422S	Axor Urquiola Free-Standing Bath Mixer (With no hand shower)	✓			4.80 litres/min
Shower Mixer	11620	Axor Urquiola Exposed Shower Mixer	✓			7.70 litres/min
Basin Mixer	12010	Axor Starck Organic Basin Mixer	✓			4.70 litres/min
Basin Mixer	12011	Axor Starck Organic Basin Mixer	✓			4.70 litres/min
Basin Mixer	12012	Axor Starck Organic Basin Mixer	✓			5.10 litres/min
Basin Mixer	12012E	Axor Starck Organic Basin Mixer		✓✓		2.90 litres/min
Basin Mixer	12013	Axor Starck Organic Basin Mixer	✓			4.80 litres/min
Basin Mixer	12014	Axor Starck Organic Basin Mixer	✓			4.70 litres/min
Basin Mixer	12015	Axor Starck Organic Wall-Mounted Basin Mixer	✓			4.70 litres/min
Basin Mixer	12016	Axor Starck Organic Floor-Standing Bath Mixer	✓			7.50 litres/min
Basin Mixer	12016E	Axor Starck Organic Floor-Standing Bath Mixer		✓✓		6.30 litres/min
Basin Mixer	12110	Axor Starck Organic Pillar tap Spray Mode	✓			5.00 litres/min
Basin Mixer	12110	Axor Starck Organic Pillar tap Mono Mode	✓			4.80 litres/min
Basin Mixer	12112E	Axor Starck V Basin Mixer		✓✓		3.40 litres/min
Bath Mixer	12410	Axor Starck Organic Exposed Bath Mixer	✓			7.10 litres/min
Bath Mixer	12410E	Axor Starck Organic Exposed Bath Mixer		✓✓		6.50 litres/min
Shower Mixer	12602	Axor Starck Organic Exposed Shower Mixer	✓			7.60 litres/min
Shower Mixer	12602E	Axor Starck Organic Exposed Shower Mixer		✓✓		6.40 litres/min
Kitchen Mixer	14850	Axor Uno Kitchen Mixer	✓			8.00 litres/min
Kitchen Mixer	14850E	Axor Uno Kitchen Mixer		✓✓		5.30 litres/min
Basin Mixer	16502	Axor Montreux Two Handle Basin Mixer	✓			4.50 litres/min
Basin Mixer	16502E	Axor Montreux Two Handle Basin Mixer		✓✓		2.90 litres/min
Basin Mixer	16505	Axor Montreux Two Handle Basin Mixer	✓			5.00 litres/min
Basin Mixer	16505E	Axor Montreux Two Handle Basin Mixer		✓✓		3.00 litres/min
Basin Mixer	16510	Axor Montreux Two Handle Basin Mixer	✓			4.90 litres/min
Bath Mixer	16547	Axor Montreux Free-Standing Bath Mixer	✓			7.62 litres/min
Basin Mixer	17010	Axor Carlton Single Lever Basin Mixer	✓			4.20 litres/min
Basin Mixer	17030	Axor Carlton Two Handle Basin Mixer	✓			4.50 litres/min
Basin Mixer	17030E	Axor Carlton Two Handle Basin Mixer		✓✓		3.10 litres/min
Basin Mixer	17133	Axor Carlton Three Hole Basin Mixer	✓			4.50 litres/min
Basin Mixer	17133E	Axor Carlton Three Hole Basin Mixer		✓✓		2.30 litres/min
Basin Mixer	18010	Axor Massaud Single Lever Basin Mixer	✓			4.20 litres/min
Basin Mixer	18010E	Axor Massaud Single Lever Basin Mixer		✓✓		4.20 litres/min
Basin Mixer	18013E	Axor Massaud Three Hole Basin Mixer		✓✓		3.30 litres/min
Basin Mixer	18013L	Axor Massaud Three Hole Basin Mixer			✓✓✓	1.70 litres/min
Basin Mixer	18020	Axor Massaud Highriser Basin Mixer	✓			4.24 litres/min
Bath Mixer	18450	Axor Massaud Free-Standing Bath Mixer	✓			7.40 litres/min
Basin Mixer	19010	Axor Bouroullec Single-Lever Basin Mixer	✓			5.30 litres/min
Basin Mixer	19123	Axor Bouroullec Two Hole Basin Mixer	✓			5.00 litres/min
Basin Mixer	19125	Axor Bouroullec Wall-Mounted Basin Mixer Spout	✓			5.10 litres/min
Basin Mixer	19127	Axor Bouroullec Wall-Mounted Basin Mixer Spout	✓			5.50 litres/min

Axor MWELS Approved Products

Type	Article No.	Descriptions	1 tick	2 ticks	3 ticks	Water Consumption
Basin Mixer	19132	Axor Bouroullec Single Lever Basin Mixer	✓			4.90 litres/min
Basin Mixer	19137	Axor Bouroullec Single Lever Basin Mixer	✓			5.20 litres/min
Basin Mixer	19138	Axor Bouroullec Single Lever Basin Mixer	✓			5.20 litres/min
Basin Mixer	19139	Axor Bouroullec Two Handle Basin Mixer	✓			5.30 litres/min
Basin Mixer	19140	Axor Bouroullec Two Handle Basin Mixer	✓			5.40 litres/min
Basin Mixer	19141	Axor Bouroullec Three Hole Basin Mixer	✓			5.20 litres/min
Basin Mixer	19143	Axor Bouroullec Two Hole Basin Mixer	✓			4.90 litres/min
Basin Mixer	19144	Axor Bouroullec Two Hole Basin Mixer	✓			5.20 litres/min
Bath Mixer	19420	Axor Bouroullec Exposed Bath Mixer	✓			7.40 litres/min
Showerpipe	19670	Axor Bouroullec Showerpipe	✓			7.40 litres/min
Basin Mixer	34010	Axor Citterio M Single Lever Basin Mixer	✓			5.00 litres/min
Basin Mixer	34010E	Axor Citterio M Single Lever Basin Mixer		✓✓		3.20 litres/min
Basin Mixer	34010L	Axor Citterio M Single Lever Basin Mixer			✓✓✓	1.60 litres/min
Basin Mixer	34017	Axor Citterio M Single Lever Basin Mixer	✓			4.70 litres/min
Basin Mixer	34017E	Axor Citterio M Single Lever Basin Mixer		✓✓		3.10 litres/min
Basin Mixer	34017L	Axor Citterio M Single Lever Basin Mixer			✓✓✓	1.60 litres/min
Basin Mixer	34112E	Axor Citterio M Wall-Mounted Basin Mixer with Plate		✓✓		3.30 litres/min
Basin Mixer	34113E	Axor Citterio M Wall-Mounted Basin Mixer with Escutcheon		✓✓		3.50 litres/min
Basin Mixer	34115	Axor Citterio M Wall-Mounted Basin Mixer with Plate	✓			5.00 litres/min
Basin Mixer	34115E	Axor Citterio M Wall-Mounted Basin Mixer with Plate		✓✓		3.20 litres/min
Basin Mixer	34116E	Axor Citterio M Wall-Mounted Basin Mixer		✓✓		3.30 litres/min
Basin Mixer	34120	Axor Citterio M Highriser Basin Mixer	✓			4.80 litres/min
Basin Mixer	34134E	Axor Citterio M Three Hole Basin Mixer		✓✓		3.40 litres/min
Basin Mixer	34134L	Axor Citterio M Three Hole Basin Mixer			✓✓✓	1.80 litres/min
Basin Mixer	34135	Axor Citterio M Three Hole Basin Mixer	✓			5.20 litres/min
Basin Mixer	34135E	Axor Citterio M Three Hole Basin Mixer		✓✓		3.00 litres/min
Basin Mixer	34135L	Axor Citterio M Three Hole Basin Mixer			✓✓✓	1.60 litres/min
Basin Mixer	34217	Axor Citterio M Three Hole Wall-Mounted Basin Mixer	✓			5.70 litres/min
Basin Mixer	34217E	Axor Citterio M Three Hole Wall-Mounted Basin Mixer		✓✓		3.00 litres/min
Basin Mixer	34217L	Axor Citterio M Three Hole Wall-Mounted Basin Mixer			✓✓✓	1.60 litres/min
Basin Mixer	34217S	Axor Citterio M Three Hole Wall-Mounted Basin Mixer	✓			4.40 litres/min
Basin Mixer	34217SE	Axor Citterio M Three Hole Wall-Mounted Basin Mixer		✓✓		3.20 litres/min
Basin Mixer	34313E	Axor Citterio M Three Hole Wall-Mounted Basin Mixer with Escutcheon		✓✓		3.30 litres/min
Basin Mixer	34314E	Axor Citterio M Three Hole Wall-Mounted Basin Mixer with Plate		✓✓		3.80 litres/min
Bath Mixer	34420	Axor Citterio M Exposed Bath Mixer	✓			7.50 litres/min
Shower Mixer	34620	Axor Citterio M Exposed Shower Mixer	✓			7.50 litres/min
Kitchen Mixer	34820E	Axor Citterio M Kitchen Mixer		✓✓		5.00 litres/min
Kitchen Mixer	35807E	Axor Allegra Steel Kitchen Mixer		✓✓		4.44 litres/min
Basin Mixer	36100	Axor Citterio Single Lever Basin Mixer	✓			4.40 litres/min
Basin Mixer	36100E	Axor Citterio Single Lever Basin Mixer		✓✓		2.20 litres/min
Basin Mixer	36101	Axor Citterio Single Lever Basin Mixer	✓			4.90 litres/min
Basin Mixer	36101E	Axor Citterio Single Lever Basin Mixer		✓✓		3.10 litres/min
Basin Mixer	36103	Axor Citterio Single Lever Basin Mixer	✓			4.40 litres/min
Basin Mixer	36103E	Axor Citterio Single Lever Basin Mixer		✓✓		2.50 litres/min
Basin Mixer	36106	Axor Citterio E Wall Mounted Basin Mixer	✓			4.40 litres/min
Basin Mixer	36106E	Axor Citterio E Wall Mounted Basin Mixer		✓✓		2.50 litres/min

Axor MWELS Approved Products

Type	Article No.	Descriptions	1 tick	2 ticks	3 ticks	Water Consumption
Basin Mixer	36108	Axor Citterio E Three Hole Basin Mixer	✓			4.40 litres/min
Basin Mixer	36108E	Axor Citterio E Three Hole Basin Mixer		✓✓		2.70 litres/min
Basin Mixer	36114	Axor Citterio E Wall-Mounted Basin Mixer	✓			4.40 litres/min
Basin Mixer	36114E	Axor Citterio E Wall-Mounted Basin Mixer		✓✓		2.50 litres/min
Basin Mixer	36115	Axor Citterio E Three Hole Basin Mixer	✓			4.40 litres/min
Basin Mixer	36115E	Axor Citterio E Three Hole Basin Mixer		✓✓		2.40 litres/min
Basin Mixer	36116	Axor Citterio E Three Hole Basin Mixer	✓			4.20 litres/min
Basin Mixer	36116E	Axor Citterio E Three Hole Basin Mixer		✓✓		2.40 litres/min
Bath Mixer	36140	Axor Citterio E Thermostatic Bath Mixer	✓			7.50 litres/min
Bath Mixer	36140E	Axor Citterio E Thermostatic Bath Mixer		✓✓		5.50 litres/min
Bath Mixer	36160	Axor Citterio E Thermostatic Bath Mixer	✓			7.50 litres/min
Bath Mixer	36160E	Axor Citterio E Thermostatic Bath Mixer		✓✓		5.70 litres/min
Basin Mixer	38000	Axor Uno Single lever Basin Mixer	✓			4.30 litres/min
Basin Mixer	38020	Axor Uno 2 Single Lever Basin Mixer	✓			5.00 litres/min
Basin Mixer	38025	Axor Uno 2 Single Lever Highriser Basin Mixer	✓			5.40 litres/min
Basin Mixer	38035	Axor Uno 2 Single Lever Basin Mixer	✓			4.20 litres/min
Basin Mixer	38112E	Axor Uno 2 Wall-Mounted Basin Mixer Plate		✓✓		3.30 litres/min
Basin Mixer	38113E	Axor Uno 2 Wall-Mounted Basin Mixer		✓✓		3.30 litres/min
Basin Mixer	38116	Axor Uno 2 Wall-Mounted Basin Mixer with Escutcheon	✓			4.60 litres/min
Bath Mixer	38420	Axor Uno 2 Single Lever Bath Mixer	✓			7.20 litres/min
Shower Mixer	38620	Axor Uno 2 Exposed Shower Mixer	✓			7.20 litres/min
Kitchen Mixer	38830L	Axor Uno 2 Kitchen Mixer			✓✓✓	3.60 litres/min
Basin Mixer	39010	Axor Citterio Single Lever Basin Mixer	✓			4.40 litres/min
Basin Mixer	39018	Axor Citterio Single Lever Basin Mixer	✓			5.10 litres/min
Basin Mixer	39018E	Axor Citterio Single Lever Basin Mixer		✓✓		3.10 litres/min
Basin Mixer	39018L	Axor Citterio Single Lever Basin Mixer			✓✓✓	1.70 litres/min
Basin Mixer	39020	Axor Citterio Single Lever Basin Mixer	✓			4.20 litres/min
Basin Mixer	39020E	Axor Citterio Single Lever Basin Mixer		✓✓		3.20 litres/min
Basin Mixer	39020L	Axor Citterio Single Lever Basin Mixer			✓✓✓	1.60 litres/min
Basin Mixer	39031E	Axor Citterio Single Lever Basin Mixer		✓✓		3.80 litres/min
Basin Mixer	39032E	Axor Citterio Single Lever Basin Mixer		✓✓		3.20 litres/min
Basin Mixer	39032L	Axor Citterio Single Lever Basin Mixer			✓✓✓	1.60 litres/min
Basin Mixer	39034	Axor Citterio Single Lever Basin Mixer	✓			4.40 litres/min
Basin Mixer	39035E	Axor Citterio Single Lever Basin Mixer		✓✓		3.80 litres/min
Basin Mixer	39112	Axor Citterio Wall-Mounted Basin Mixer	✓			4.80 litres/min
Basin Mixer	39112E	Axor Citterio Wall-Mounted Basin Mixer		✓✓		2.70 litres/min
Basin Mixer	39112L	Axor Citterio Wall-Mounted Basin Mixer			✓✓✓	1.60 litres/min
Basin Mixer	39113	Axor Citterio Wall-Mounted Basin Mixer with Escutcheon	✓			4.90 litres/min
Basin Mixer	39113E	Axor Citterio Wall-Mounted Basin Mixer with Escutcheon		✓✓		3.00 litres/min
Basin Mixer	39113L	Axor Citterio Wall-Mounted Basin Mixer with Escutcheon			✓✓✓	1.60 litres/min
Basin Mixer	39115	Axor Citterio Wall-Mounted Basin Mixer with plate	✓			5.10 litres/min
Basin Mixer	39115E	Axor Citterio Wall-Mounted Basin Mixer with plate		✓✓		2.90 litres/min
Basin Mixer	39115L	Axor Citterio Wall-Mounted Basin Mixer with plate			✓✓✓	1.60 litres/min
Basin Mixer	39116	Axor Citterio Wall-Mounted Basin Mixer	✓			4.80 litres/min
Basin Mixer	39116L	Axor Citterio Wall-Mounted Basin Mixer			✓✓✓	1.60 litres/min
Basin Mixer	39134	Axor Citterio Three Hole Basin Mixer	✓			4.44 litres/min
Basin Mixer	39143	Axor Citterio Three Hole Basin Mixer	✓			4.96 litres/min
Bath Mixer	39400	Axor Citterio Exposed Bath Mixer	✓			8.00 litres/min

Axor MWELS Approved Products

Type	Article No.	Descriptions	1 tick	2 ticks	3 ticks	Water Consumption
Bath Mixer	39451	Axor Citterio Free-Standing Bath Mixer		✓✓		6.40 litres/min
Shower Mixer	39600	Axor Citterio Exposed Shower Mixer	✓			7.40 litres/min
Kitchen Mixer	39835	Axor Citterio M Kitchen Mixer	✓			7.70 litres/min
Kitchen Mixer	39835E	Axor Citterio M Kitchen Mixer		✓✓		5.10 litres/min
Kitchen Mixer	39835L	Axor Citterio M Kitchen Mixer			✓✓✓	3.90 litres/min
Kitchen Mixer	39840E	Axor Citterio Semi Pro Kitchen Mixer		✓✓		4.30 litres/min
Kitchen Mixer	39840L	Axor Citterio Semi Pro Kitchen Mixer			✓✓✓	4.00 litres/min
Kitchen Mixer	39850	Axor Citterio Kitchen Mixer	✓			7.10 litres/min
Kitchen Mixer	39850E	Axor Citterio Kitchen Mixer		✓✓		5.20 litres/min

Basin

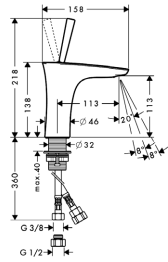

Single Lever Basin Mixer DN15

- joystick cartridge
- adjustable spray former
- push-open waste set 1 1/4"
- PEX hoses with 1/2" connecting nut
- suitable for continuous flow water heaters
- quality mark under application
- dirt filter inside hoses
- MWELS 1 tick, 2 ticks & 3 ticks

Code No. 15070000
15070000E
15070000L
15070400
15070400E
15070400L

Colour pure chrome
white chrome



✓ Good
Water Consumption: 4.26 litres/min
Type of Product: Basin Taps and Mixers
Brand: Hansgrohe
Model: Pura Vida Single Lever Basin Mixer 15070
Reg no.: BST-2009/003425



✓✓ Very Good
Water Consumption: 2.90 litres/min
Type of Product: Basin Taps and Mixers
Brand: Hansgrohe
Model: Pura Vida 15070E
Reg no.: BST-2014/016390



✓✓✓ Excellent
Water Consumption: 1.60 litres/min
Type of Product: Basin Taps and Mixers
Brand: Hansgrohe
Model: Pura Vida 15070L
Reg no.: BST-2014/016467

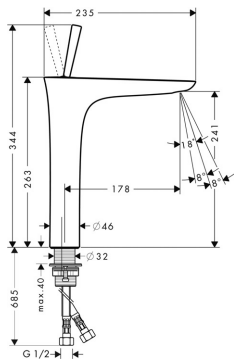

Single Lever Basin Mixer DN15 for wash bowls

- joystick cartridge
- adjustable spray former
- push-open waste set 1 1/4"
- PEX hoses with 1/2" connecting nut
- suitable for continuous flow water heaters
- quality mark under application
- dirt filter inside hoses
- MWELS 1 tick, 2 ticks & 3 ticks

Code No. 15072000
15072000E
15072000L
15072400
15072400E
15072400L

Colour pure chrome
white chrome



✓ Good
Water Consumption: 4.14 litres/min
Type of Product: Basin Taps and Mixers
Brand: Hansgrohe
Model: Pura Vida Highriser Basin Mixer 15072
Reg no.: BST-2009/003427



✓✓ Very Good
Water Consumption: 3.10 litres/min
Type of Product: Basin Taps and Mixers
Brand: Hansgrohe
Model: Pura Vida 15072E
Registration no.: BST-2015/017283



✓✓✓ Excellent
Water Consumption: 1.70 litres/min
Type of Product: Basin Taps and Mixers
Brand: Hansgrohe
Model: Pura Vida 15072L
Registration no.: BST-2015/017302

Basin

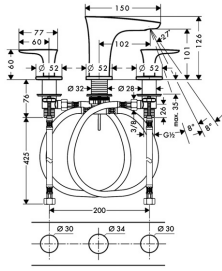

3-Hole Basin Mixer DN15

- ceramic valves hot/cold 90°
- fixed spout
- adjustable spray former
- push-open waste set 1 1/4"
- PEX hoses with 3/8" connecting nut
- suitable for continuous flow water heaters
- quality mark under application
- dirt filter inside spout
- MWELS 1 tick

Code No. 15073000
15073400

Colour pure chrome
white chrome



✓ Good
Water Consumption: 4.40 litres/min
Type of Product: Basin Taps and Mixers
Brand: Hansgrohe
Model: Pura Vida Three Hole Basin Mixer 15073
Reg no.: BST-2009/003433

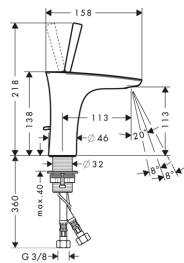

Single lever basin mixer 110 with pop-up waste set

- ComfortZone 110
- projection 113 mm
- laminar spray
- adjustable spray farmer
- joystick ceramic cartridge
- pop-up waste set G 1 1/4
- suitable for continuous flow water heaters
- connection dimension: DN15
- MWELS 2 ticks

Code No. 15074000E
15074400E

Colour pure chrome
white chrome



✓✓ Very Good
Water Consumption: 3.30 litres/min
Type of Product: Basin Taps and Mixers
Brand: Hansgrohe
Model: Pura Vida 15074E
Registration No.: BST-2015/017587

Basin

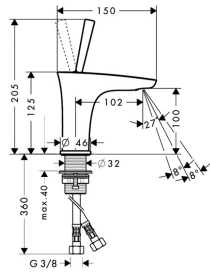

Single Lever Basin Mixer DN15 for hand basins

- joystick cartridge
- adjustable spray former
- push-open waste set 1 1/4"
- PEX hoses with 3/8" connecting nut
- suitable for continuous flow water heaters
- quality mark under application
- dirt filter inside hoses
- MWELS 1 tick

Code No. 15075000
15075400

Colour pure chrome
white chrome



✓ Good
Water Consumption: 4.30 litres/min
Type of Product: Basin Taps and Mixers
Brand: Hansgrohe
Model: Pura Vida Single Lever Basin Mixer (small) 15075
Reg no.: BST-2009/003429

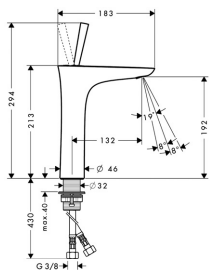

Single Lever Basin Mixer 200 with push-open waste set

- ComfortZone 200
- laminar spray
- adjustable spray former
- joystick ceramic cartridge
- push-open waste set G 1 1/4"
- suitable for continuous flow water heaters
- connection dimension: DN15
- MWELS 1 tick & 2 ticks

Code No. 15081000
15081000E
15081400
15081400E

Colour pure chrome
white chrome



✓ Good
Water Consumption: 4.50 litres/min
Type of Product: Basin Taps and Mixers
Brand: Hansgrohe
Model: Pura Vida 15081
Reg no.: BST-2014/014701



✓✓ Very Good
Water Consumption: 3.10 litres/min
Type of Product: Basin Taps and Mixers
Brand: Hansgrohe
Model: Pura Vida 15081E
Reg no.: BST-2014/014702

Basin

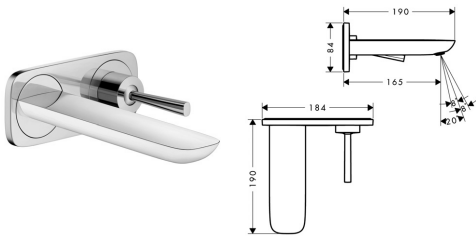

Single Lever Basin Mixer for concealed installation with spout 165mm wall-mounted

- projection 165mm
- laminar spray
- adjustable spray former
- joystick ceramic cartridge
- non-closing flush grated valve
- suitable for continuous flow water heaters
- connection dimensions: DN15
- MWELS 1 tick & 2 ticks

Code No. 15084000
15084000E
15084400
15084400E

Colour pure chrome
white chrome



✓ **Good**
Water Consumption: 4.50 litres/min
Type of Product: Basin Taps and Mixers
Brand: Hansgrohe
Model: PuraVida Wall Mounted
Basin Mixer 165mm 15084
Reg no.: BST-2013/013286



✓✓ **Very Good**
Water Consumption: 3.00 litres/min
Type of Product: Basin Taps and Mixers
Brand: Hansgrohe
Model: PuraVida Wall Mounted
Basin Mixer 165mm 15084E
Reg no.: BST-2013/013287

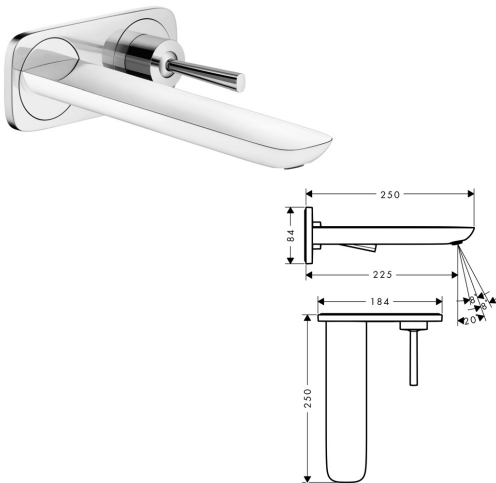

Single Lever Basin Mixer for concealed installation with spout 225 mm wall-mounted

- projection 225 mm
- laminar spray
- adjustable spray former
- joystick ceramic cartridge
- non-closing flush grated valve
- suitable for continuous flow water heaters
- connection dimension: DN15
- handle can be positioned on the right or left, depends on the basic set installation
- MWELS 1 tick & 2 ticks

Code No. 15085000
15085000E
15085400
15085400E

Colour pure chrome
white chrome

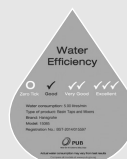

✓ **Good**
Water Consumption: 5.00 litres/min
Type of Product: Basin Taps and Mixers
Brand: Hansgrohe
Model: 15085
Reg no.: BST-2014/015597



✓✓ **Very Good**
Water Consumption: 2.90 litres/min
Type of Product: Basin Taps and Mixers
Brand: Hansgrohe
Model: 15085E
Reg no.: BST-2014/015598

Bath

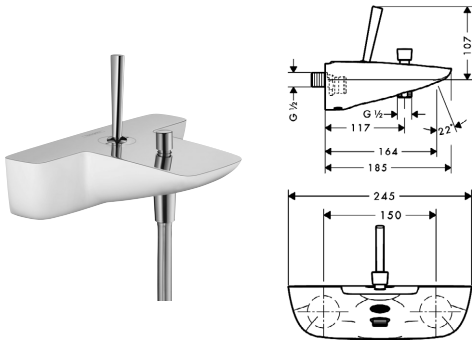

Single Lever Bath Mixer for exposed installation

- s-shaped connections
- centre distance 150± 12mm
- projection: 164mm
- normal spray
- joystick ceramic cartridge
- temperature limitation not adjustable
- with automatic resetting
- non-return valve
- with silencer
- suitable for continuous flow water heaters
- connection dimensions: DN15
- MWELS 1 tick & 2 ticks

Code No. 15472000
15472000E
15472400
15472400E

Colour pure chrome
white chrome



✓ Good
Water Consumption: 7.60 litres/min
Type of Product: Shower Taps and Mixers
Brand: Hansgrohe
Model: PuraVida Exposed Basin Mixer 15472
Reg no.: SHT-2010/005036



✓✓ Very Good
Water Consumption: 6.20 litres/min
Type of Product: Shower Taps and Mixers
Brand: Hansgrohe
Model: 15472E
Reg no.: SHT-2014/015910

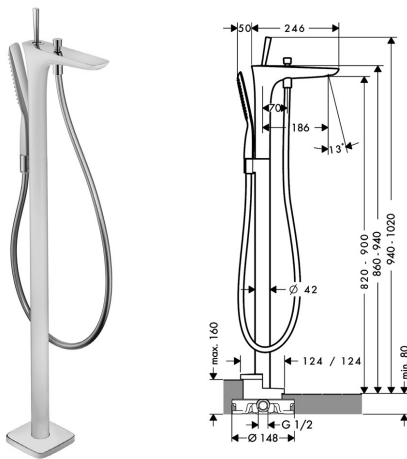

Single Lever Bath Mixer DN15 floor mounted

- for mounting on the bathroom floor
- joystick cartridge
- non-return valve
- automatically reverts from shower to bath filler
- with PuraVida 1jet hand shower (no.28558000), shower hose 1.25m (no.28272000), diverter

for use with:

- basic set (no.10452180)
- seal (no.96441000)
- quality mark under application
- MWELS 1 tick

Code No. 15473000
15473400

Colour pure chrome
white chrome



✓ Good
Water Consumption: 7.30 litres/min
Type of Product: Basin Taps and Mixers
Brand: Hansgrohe
Model: PuraVida Free Standing Bath Mixer 15473
Reg no.: SHT-2010/005552

Shower

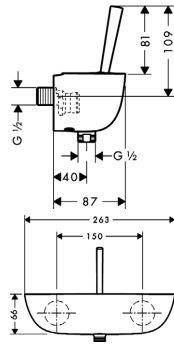

Single Lever Basin Mixer for exposed installation

- centre distance 150± 12mm
- joystick ceramic cartridge
- non-return valve
- with silencer
- hose connection DN15
- connection dimension: DN15
- MWELS 1 tick

Code No. 15672000
15672400

Colour pure chrome
white chrome



✓ Good

Water Consumption: 7.50 litres/min

Type of Product: Basin Taps and Mixers

Brand: Hansgrohe

Model: PuraVida Exposed Shower Mixer 15672

Reg no.: SHT-2010/004539

Basin

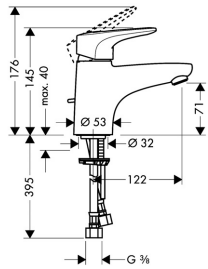

Single Lever Basin Mixer DN15

- ceramic cartridge
- Boltic lever lock
- adjustable temperature restriction
- QuickClean aerator
- pop-up waste set 1 1/4"
- suitable for continuous flow water heaters
- MWELS 2 ticks

Code No. 14070000E
14070090E
Colour chrome
chrome/goldoptic



✓✓ Very Good
Water Consumption: 3.90 litres/min
Type of Product: Basin Taps and Mixers
Brand: Hansgrohe
Model: Metropol E basin mixer
Reg no.: BST-2009/001680

Bath

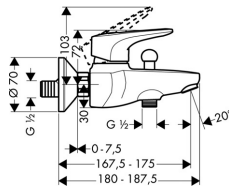

Single Lever Bath Mixer DN15 for exposed fitting

- ceramic cartridge, Boltic lever lock
- adjustable temperature restriction
- QuickClean aerator
- button with stop/diverter valve to revert from shower to bath filler
- centre distance 150± 12mm, S-shaped connections with noise reduction
- PA-IX 9873/IBB
- MWELS 1 tick

Code No. 14470000
14470090
Colour chrome
chrome/goldoptic



✓ Good
Water Consumption: 7.32 litres/min
Type of Product: Shower Taps and Mixers
Brand: Hansgrohe
Model: Metropol E exposed bath mixer
Reg no.: SHT-2009/001546

Shower

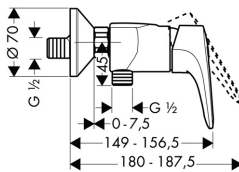

Single Lever Shower Mixer DN15 for exposed fitting

- ceramic cartridge, Boltic lever lock
- non-return valve
- adjustable temperature regulation
- QuickClean aerator
- centre distance 150± 12mm
- S-shaped connections with noise reduction
- PA-IX 9874/IA
- MWELS 1 tick

Code No. 14670000
14670090
Colour chrome
chrome/goldoptic



✓ Good
Water Consumption: 7.46 litres/min
Type of Product: Shower Taps and Mixers
Brand: Hansgrohe
Model: Metropol E exposed shower mixer
Reg no.: SHT-2009/001545

Basin

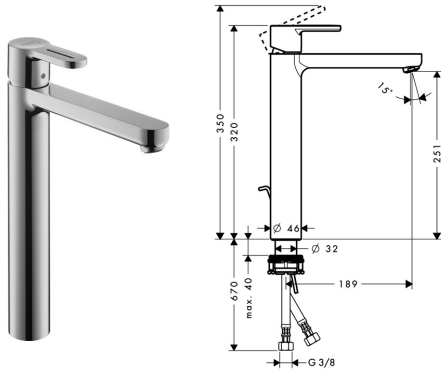

Single Lever Basin Mixer DN15 for wash basins

- ceramic cartridge
- Boltic lever lock
- adjustable temperature restriction
- QuickClean aerator
- pop-up waste set 1 1/4"
- suitable for continuous flow water heaters
- MWELS 1 tick

Code No. 14020000
14020880
Colour chrome
satin chrome



✓ Good
Water Consumption: 4.40 litres/min
Type of Product: Basin Taps and Mixers
Brand: Hansgrohe
Model: Metropol S
Reg no.: BST-2009/001679

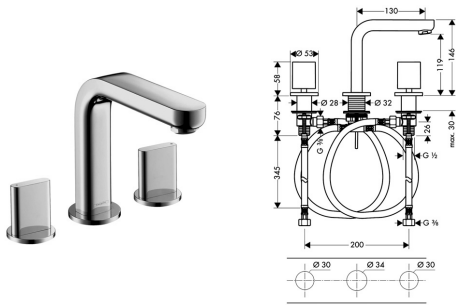

3-Hole Basin Mixer DN15

- valves hot/cold 90°
- ceramic discs
- fixed spout
- QuickClean aerator
- pop-up waste set 1 1/4"
- suitable for continuous flow water heaters
- MWELS 1 tick

Code No. 14063000
14063880
Colour chrome
satin chrome



✓ Good
Water Consumption: 4.40 litres/min
Type of Product: Basin Taps and Mixers
Brand: Hansgrohe
Model: Metropol S Three Hole Basin Mixer 14063
Reg no.: BST-2010/003952

Bath

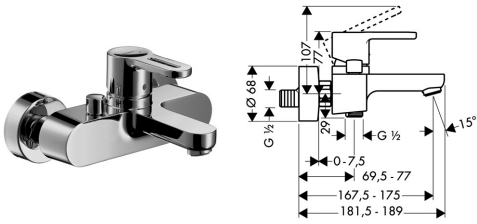

Single Lever Bath Mixer DN15 for exposed fitting

- ceramic cartridge
- Boltic lever lock
- non-return valve
- adjustable temperature restriction
- QuickClean aerator
- button with stop/diverter valve to revert from shower to bath filler
- centre distance 150± 12mm, S-shaped connections with noise reduction,
- MWELS 1 tick

Code No. 14461000
14461880

Colour chrome
satin chrome



✓ Good
Water Consumption: 7.25 litres/min
Type of Product: Shower Taps and Mixers
Brand: Hansgrohe
Model: Metropol S exposed bath mixer
Reg no.: SHT-2009/001544

Shower

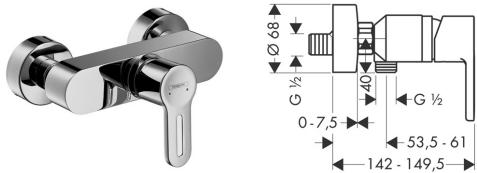

Single Lever Shower Mixer DN15 for exposed fitting

- ceramic cartridge
- Boltic lever lock
- non-return valve
- adjustable temperature regulation
- centre distance 150± 12mm
- S-shaped connections with noise reduction
- MWELS 1 tick

Code No. 14661000
14661880

Colour chrome
satin chrome



✓ Good
Water Consumption: 7.25 litres/min
Type of Product: Shower Taps and Mixers
Brand: Hansgrohe
Model: Metropol S exposed shower mixer
Reg no.: SHT-2009/001543

Basin

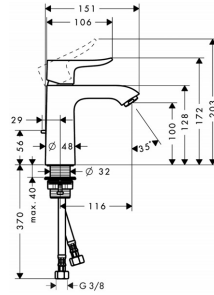

Single Lever Basin Mixer 110 with pop-up waste set

- ComfortZone 110
- normal spray
- ceramic cartridge
- temperature limitation adjustable
- pop-up waste set G 1 1/4"
- suitable for continuous flow water heaters
- connection dimension: DN15
- MWELS 1 tick, 2 ticks & 3 ticks

Code No. 31080000
31080000E
31080000L

Colour chrome



✓ **Good**
Water Consumption: 5.00 litres/min
Type of Product: Basin Taps and Mixers
Brand: Hansgrohe
Model: Metris Single Lever Basin Mixer 110mm 31080
Reg no.: BST-2011/007451



✓✓ **Very Good**
Water Consumption: 3.10 litres/min
Type of Product: Basin Taps and Mixers
Brand: Hansgrohe
Model: Metris 31080E
Reg no.: BST-2014/014301



✓✓✓ **Excellent**
Water Consumption: 1.60 litres/min
Type of Product: Basin Taps and Mixers
Brand: Hansgrohe
Model: Metris 31080L
Reg no.: BST-2014/014302

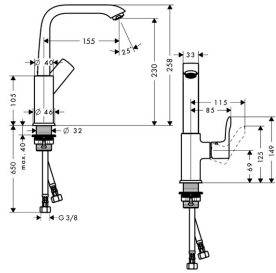

Single Lever Basin Mixer 230 DN15 without waste set

- ComfortZone 230mm
- swivel range 120°
- without waste set
- ceramic cartridge
- adjustable temperature restriction
- QuickClean aerator
- suitable for continuous flow water heaters
- quality mark under application
- MWELS 1 tick

Code No. 31081000

Colour chrome



✓ **Good**
Water Consumption: 5.10 litres/min
Type of Product: Basin Taps and Mixers
Brand: Hansgrohe
Model: Metris Basin Mixer 230mm W/O Waste 31081
Reg no.: BST-2011/008034

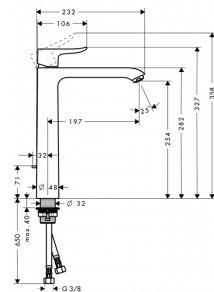

Single Lever Basin Mixer 260 with pop-up waste set for washbowls

- ComfortZone 260
- normal spray
- ceramic cartridge
- temperature limitation adjustable
- pop-up waste set G 1 1/4"
- suitable for continuous flow water heaters
- connection dimension: DN15
- MWELS 1 tick, 2 ticks & 3 ticks

Code No. 31082000
31082000E
31082000L

Colour chrome



✓ **Good**
Water Consumption: 5.10 litres/min
Type of Product: Basin Taps and Mixers
Brand: Hansgrohe
Model: 31082
Reg no.: BST-2014/015911



✓✓ **Very Good**
Water Consumption: 3.00 litres/min
Type of Product: Basin Taps and Mixers
Brand: Hansgrohe
Model: 31082E
Reg no.: BST-2014/015912



✓✓✓ **Excellent**
Water Consumption: 1.80 litres/min
Type of Product: Basin Taps and Mixers
Brand: Hansgrohe
Model: 31082L
Reg no.: BST-2014/015913

Basin

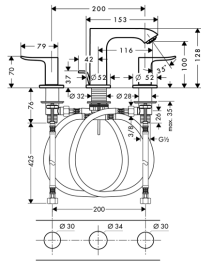

Single Lever Basin Mixer for concealed installation with spout 100mm wall-mounted

- projection 100mm
- normal spray
- ceramic cartridge
- temperature limitation adjustable
- non-closing flush grated valve
- connection dimension: DN15
- MWELS 1 tick, 2 ticks & 3 ticks

Code No. 31083000
31083000E
31083000L

Colour chrome



✓ Good
Water Consumption: 5.40 litres/min
Type of Product: Basin Taps and Mixers
Brand: Hansgrohe
Model: 31083
Reg no.: BST-2014/015606



✓✓ Very Good
Water Consumption: 3.10 litres/min
Type of Product: Basin Taps and Mixers
Brand: Hansgrohe
Model: 31083E
Reg no.: BST-2014/015607



✓✓✓ Excellent
Water Consumption: 1.60 litres/min
Type of Product: Basin Taps and Mixers
Brand: Hansgrohe
Model: 31083L
Reg no.: BST-2014/015596

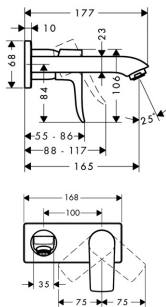

Single Lever Basin Mixer for concealed installation with spout 165mm wall-mounted

- projection 165mm
- normal spray
- ceramic cartridge
- temperature limitation adjustable
- non-closing flush grated valve
- connection dimension: DN15
- MWELS 1 tick, 2 ticks & 3 ticks

Code No. 31085000
31085000E
31085000L

Colour chrome



✓ Good
Water Consumption: 5.10 litres/min
Type of Product: Basin Taps and Mixers
Brand: Hansgrohe
Model: Metris 31085
Reg no.: BST-2014/014519



✓✓ Very Good
Water Consumption: 3.20 litres/min
Type of Product: Basin Taps and Mixers
Brand: Hansgrohe
Model: Metris 31085E
Reg no.: BST-2014/014520



✓✓✓ Excellent
Water Consumption: 1.70 litres/min
Type of Product: Basin Taps and Mixers
Brand: Hansgrohe
Model: Metris 31085L
Reg no.: BST-2014/014602

Basin

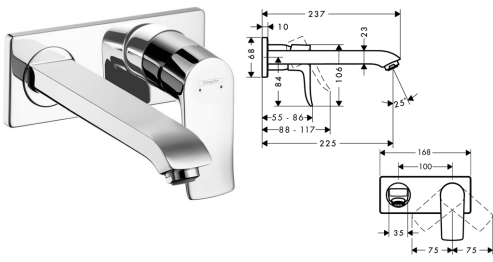

Single Lever Basin Mixer for concealed installation with spout 225 mm wall-mounted

- projection 225mm
- normal spray
- ceramic cartridge
- temperature limitation adjustable
- non-closing flush grated valve
- connection dimension: DN15
- handle can be positioned on the right or left, depends on the basic set installation
- MWELS 1 tick, 2 ticks & 3 ticks

Code No. 31086000
31086000E
31086000L

Colour chrome



✓ Good
Water Consumption: 5.40 litres/min
Type of Product: Basin Taps and Mixers
Brand: Hansgrohe
Model: 31086
Reg no.: BST-2014/014481



✓✓ Very Good
Water Consumption: 2.80 litres/min
Type of Product: Basin Taps and Mixers
Brand: Hansgrohe
Model: 31086E
Reg no.: BST-2014/014482



✓✓✓ Excellent
Water Consumption: 1.60 litres/min
Type of Product: Basin Taps and Mixers
Brand: Hansgrohe
Model: Metris 31086L
Reg no.: BST-2014/015050

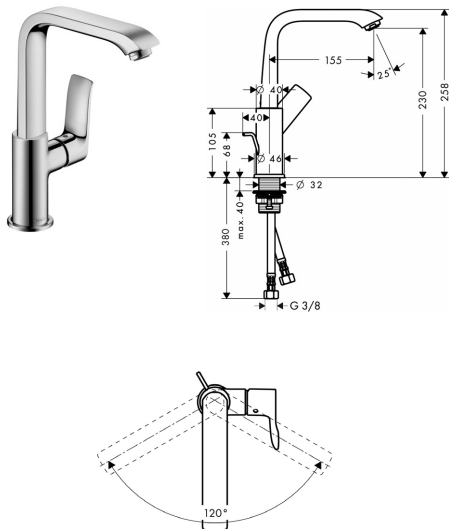

Single Lever Basin Mixer 230 DN15

- ComfortZone 230mm
- swivel range 120°
- ceramic cartridge
- adjustable temperature restriction
- QuickClean aerator
- pop-up waste set G 1 1/4"
- suitable for continuous flow water heaters
- quality mark under application
- MWELS 1 tick

Code No. 31087000

Colour chrome



✓ Good
Water Consumption: 4.80 litres/min
Type of Product: Basin Taps and Mixers
Brand: Hansgrohe
Model: Metris Single Lever Basin Mixer 230mm 31087
Reg no.: BST-2011/007452

Basin

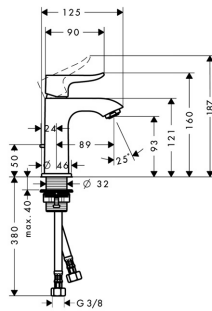

Single Lever Basin Mixer 100 DN15 for hand basins

- ComfortZone 100mm
- ceramic cartridge, boltic lever lock
- adjustable temperature restriction
- QuickClean aerator
- pop-up waste set G 1 1/4"
- suitable for continuous flow water heaters
- quality mark under application
- MWELS 1 tick

Code No. 31088000

Colour chrome



✓ Good

Water Consumption: 5.30 litres/min

Type of Product: Basin Taps and Mixers

Brand: Hansgrohe

Model: Metris Single Lever Basin Mixer 100mm 31088

Reg no.: BST-2011/008033

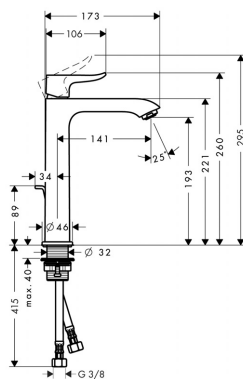

Single Lever Basin Mixer 200 DN15

- ComfortZone 200mm
- for flat wash bowls and high wash basins
- ceramic cartridge
- Boltic lever lock
- adjustable temperature restriction
- QuickClean aerator
- pop-up waste set G 1 1/4"
- suitable for continuous flow water heaters
- quality mark under application
- MWELS 1 tick

Code No. 31183000

Colour chrome



✓ Good

Water Consumption: 5.50 litres/min

Type of Product: Basin Taps and Mixers

Brand: Hansgrohe

Model: Metris Single Lever Basin Mixer 200mm 31183

Reg no.: BST-2011/008251

Basin

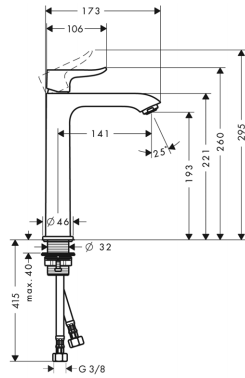

Single lever basin mixer 200 without waste set

- ComfortZone 200mm
- projection 141 mm
- normal spray
- ceramic cartridge
- temperature limitation adjustable
- pop-up waste set G 1¹/₄
- suitable for continuous flow water heaters
- connection dimension: DN15
- MWELS 1 tick & 2 ticks

Code No. 31185000
31185000E

Colour chrome



✓ Good

Water Consumption: 4.40 litres/min
Type of Product: Basin Taps and Mixers
Brand: Hansgrohe
Model: 31185
Reg no.: BST-2015/017742



✓✓ Very Good

Water Consumption: 2.30 litres/min
Type of Product: Basin Taps and Mixers
Brand: Hansgrohe
Model: 31185E
Reg no.: BST-2015/017743

Basin

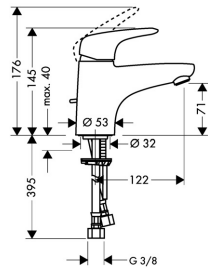

Single Lever Basin Mixer DN15

- ceramic cartridge
- Boltic lever lock
- adjustable temperature restriction
- QuickClean aerator
- pop-up waste set 1 1/4"
- suitable for continuous flow water heaters
- MWELS 1 tick

Code No. 31070000

Colour chrome



✓ Good

Water Consumption: 4.60 litres/min

Type of Product: Basin Taps and Mixers

Brand: Hansgrohe

Model: Metris E Single Lever Basin Mixer 31070

Reg no.: BST-2010/004640

Bath

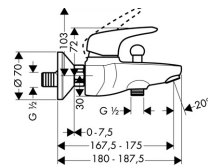

Single Lever Bath Mixer DN15 for exposed fitting

- ceramic cartridge, Boltic lever lock
- adjustable temperature restriction
- QuickClean aerator
- button with stop/diverter valve to revert from shower to bath filler
- centre distance 150± 12mm
- S-shaped connections with noise reduction
- MWELS 1 tick

Code No. 31470000

Colour chrome



✓ Good

Water Consumption: 7.35 litres/min

Type of Product: Shower Taps and Mixers

Brand: Hansgrohe

Model: Metris E exposed bath mixer

Reg no.: SHT-2009/001654

Shower

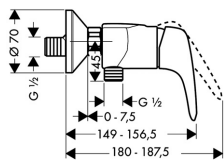

Single Lever Shower Mixer DN15

- ceramic cartridge
- Boltic lever lock
- non-return valve
- adjustable temperature regulation
- centre distance 150± 12mm
- S-shaped connections with noise reduction
- MWELS 1 tick

Code No. 31670000

Colour chrome



✓ Good

Water Consumption: 7.48 litres/min

Type of Product: Shower Taps and Mixers

Brand: Hansgrohe

Model: Metris E exposed shower mixer

Reg no.: SHT-2009/001653

Basin

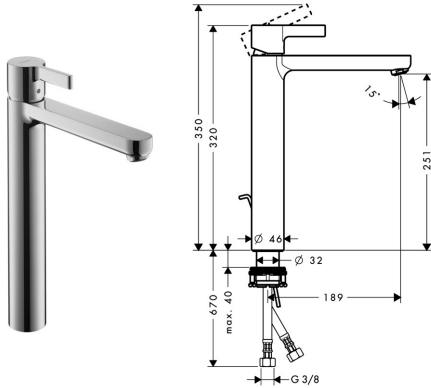

Single Lever Basin Mixer with pop-up waste set for washbowls

- normal spray
- ceramic cartridge
- temperature limitation adjustable
- pop-up waste set G 1 1/4"
- suitable for continuous flow water heaters
- connection dimension: DN15
- MWELS 1 tick, 2 ticks & 3 ticks

Code No. 31022000
31022000E
31022000L

Colour chrome



✓ Good
Water Consumption: 4.20 litres/min
Type of Product: Basin Taps and Mixers
Brand: Hansgrohe
Model: Metris 'S' (Highriser)
Reg no.: BST-2009/001302



✓✓ Very Good
Water Consumption: 2.90 litres/min
Type of Product: Basin Taps and Mixers
Brand: Hansgrohe
Model: 31022E
Reg no.: BST-2014/014586



✓✓✓ Excellent
Water Consumption: 2.00 litres/min
Type of Product: Basin Taps and Mixers
Brand: Hansgrohe
Model: 31022L
Reg no.: BST-2014/014587

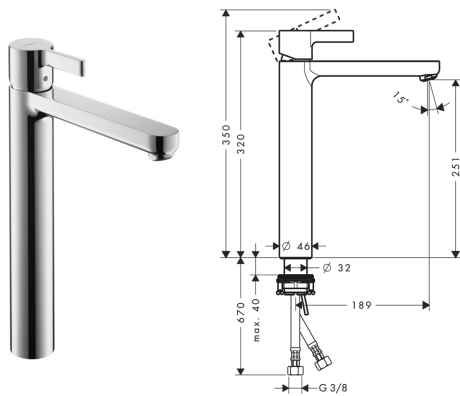

Single lever basin mixer without waste set for washbowls

- projection 189 mm
- normal spray
- ceramic cartridge
- temperature limitation adjustable
- pop-up waste set G 1 1/4"
- suitable for continuous flow water heaters
- connection dimension: DN15
- MWELS 1 tick & 2 ticks

Code No. 31023000
31023000E

Colour chrome



✓ Good
Water Consumption: 4.70 litres/min
Type of Product: Basin Taps and Mixers
Brand: Hansgrohe
Model: 31023
Reg no.: BST-2015/017747



✓✓ Very Good
Water Consumption: 3.00 litres/min
Type of Product: Basin Taps and Mixers
Brand: Hansgrohe
Model: 31023E
Reg no.: BST-2015/017748

Basin

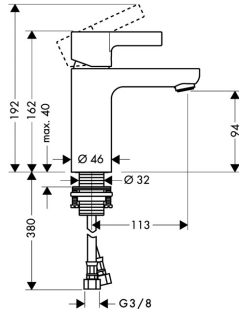

Single Lever Basin Mixer with pop-up waste set

- normal spray
- ceramic cartridge
- temperature limitation adjustable
- pop-up waste set G 1 1/4"
- suitable for continuous flow water heaters
- connection dimension: DN15
- MWELS 1 tick, 2 ticks & 3 ticks

Code No. 31060000
31060000E
31060000L

Colour chrome



✓ Good
Water Consumption: 4.50 litres/min
Type of Product: Basin Taps and Mixers
Brand: Hansgrohe
Model: Metris S Single Lever Basin Mixer 31060
Reg no.: BST-2010/004515



✓✓ Very Good
Water Consumption: 3.20 litres/min
Type of Product: Basin Taps and Mixers
Brand: Hansgrohe
Model: Metris 'S' Single Lever Basin Mixer 31060E
Reg no.: BST-2009/003426



✓✓✓ Excellent
Water Consumption: 1.80 litres/min
Type of Product: Basin Taps and Mixers
Brand: Hansgrohe
Model: Metris S 31060L
Reg no.: BST-2014/015008

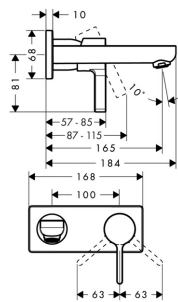
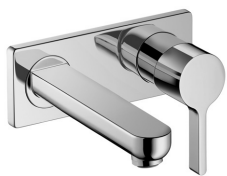

Single Lever Basin Mixer, DN15, for concealed installation with spout 165mm

- ceramic cartridge
- Boltic lever lock
- adjustable temperature restriction
- flush grated waste
- suitable for continuous flow water heaters
- for use with:
 - basic set no.13622180
 - MWELS 1 tick & 2 ticks

Code No. 31162000
31162000E

Colour chrome



✓ Good
Water Consumption: 5.40 litres/min
Type of Product: Basin Taps and Mixers
Brand: Hansgrohe
Model: METRIS S 31162 + 13622180
Reg no.: BST-2013/012588



✓✓ Very Good
Water Consumption: 3.00 litres/min
Type of Product: Basin Taps and Mixers
Brand: Hansgrohe
Model: METRIS S 31162E + 13622180
Reg no.: BST-2013/012587

Basin

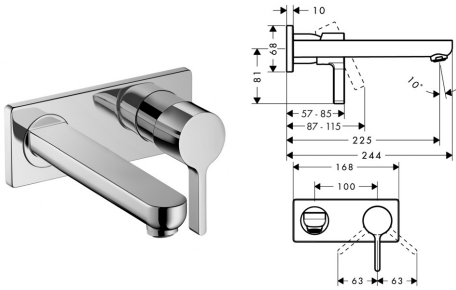

Single Lever Basin Mixer, DN15, for concealed installation with spout 225mm

- ceramic cartridge, boltic lever lock
- adjustable temperature restriction
- flush grated waste
- suitable for continuous flow water heaters for use with:
- basic set no.13622180
- MWELS 1 tick, 2 ticks & 3 ticks

Code No. 31163000
31163000E
31163000L

Colour chrome



✓ Good
Water Consumption: 5.50 litres/min
Type of Product: Basin Taps and Mixers
Brand: Hansgrohe
Model: METRIS S 31163 + 13622180
Reg no.: BST-2013/012586



✓✓ Very Good
Water Consumption: 3.00 litres/min
Type of Product: Basin Taps and Mixers
Brand: Hansgrohe
Model: METRIS S 31163E + 13622180
Reg no.: BST-2013/012585



✓✓✓ Excellent
Water Consumption: 1.70 litres/min
Type of Product: Basin Taps and Mixers
Brand: Hansgrohe
Model: METRIS S 31163L
Reg no.: BST-2014/015084

Bath

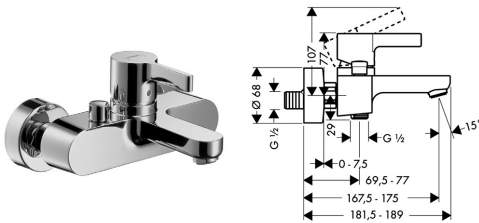

Single Lever Bath Mixer for exposed fitting DN15

- ceramic cartridge, Boltic lever lock
- non-return valve, adjustable temperature restriction
- QuickClean aerator
- button with stop/diverter valve to revert from shower to bath filler
- centre distance 150± 12mm, S-shaped connections with noise reduction, PA-IX 9952/ICB
- DVGW NW-6506BR5787
- MWELS 1 tick

Code No. 31460000
31460000L

Colour chrome



✓ Good
Water Consumption: 7.61 litres/min
Type of Product: Shower Taps and Mixers
Brand: Hansgrohe
Model: Metris S Exposed Bath Mixer
Reg no.: SHT-2009/001652



✓✓✓ Excellent
Water Consumption: 4.80 litres/min
Type of Product: Shower Taps and Mixers
Brand: Hansgrohe
Model: 31460L
Reg no.: SHT-2014/015914

Shower

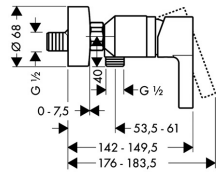

Single Lever Shower Mixer DN15 for exposed fitting

- ceramic cartridge, Boltic lever lock
- non-return valve
- adjustable temperature regulation
- centre distance 150 ± 12 mm
- S-shaped connections with noise reduction
- MWELS 1 tick, 2 ticks & 3 ticks

Code No. 31660000
31660000E
31660000L

Colour chrome



✓ **Good**
Water Consumption: 7.40 litres/min
Type of Product: Shower Taps and Mixers
Brand: Hansgrohe
Model: Metris S Exposed Shower Mixer
Reg no.: SHT-2009/001651



✓✓ **Very Good**
Water Consumption: 5.30 litres/min
Type of Product: Shower Taps and Mixers
Brand: Hansgrohe
Model: Metris S 31660E
Reg no.: SHT-2014/015403



✓✓✓ **Excellent**
Water Consumption: 4.60 litres/min
Type of Product: Shower Taps and Mixers
Brand: Hansgrohe
Model: Metris S 31660L
Reg no.: SHT-2014/015406

Basin

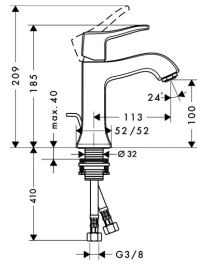

Single Lever Basin Mixer DN15

- ceramic cartridge
- Boltic lever lock
- adjustable temperature restriction
- QuickClean aerator
- pop-up waste set 1 1/4"
- suitable for continuous flow water heaters
- MWELS 1 tick

Code No. 31075000
31075820
Colour chrome
brushed nickel



✓ Good
Water Consumption: 4.30 litres/min
Type of Product: Basin Taps and Mixers
Brand: Hansgrohe
Model: Metris Classic Single Lever Basin Mixer 31075
Reg no.: BST-2009/003753

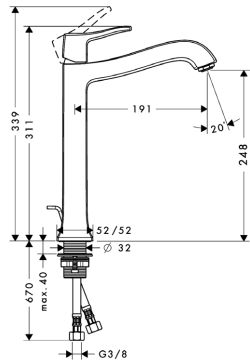

Single Lever Basin Mixer DN15 for wash bowls

- ceramic cartridge
- Boltic lever lock
- adjustable temperature restriction
- QuickClean aerator
- pop-up waste set 1 1/4"
- suitable for continuous flow water heaters
- MWELS 1 tick

Code No. 31078000
31078820
Colour chrome
brushed nickel



✓ Good
Water Consumption: 4.20 litres/min
Type of Product: Basin Taps and Mixers
Brand: Hansgrohe
Model: Metris Classic Highriser Basin Mixer 31078
Reg no.: BST-2010/004536

Bath

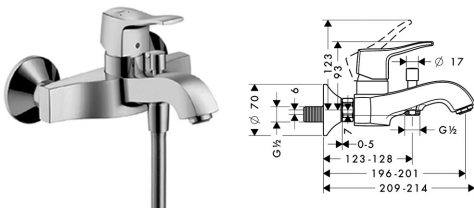

Single Lever Bath Mixer DN15 for exposed fitting

- ceramic cartridge, Boltic lever lock
- adjustable temperature restriction
- QuickClean aerator
- button with stop/diverter valve to revert from shower to bath filler
- centre distance 150± 12mm, S-shaped connections with noise reduction
- MWELS 1 tick

Code No. 31478000
31478820
Colour chrome
brushed nickel



✓ Good
Water Consumption: 8.00 litres/min
Type of Product: Shower Taps and Mixers
Brand: Hansgrohe
Model: Metris Classic Exposed Bath Mixer 31478
Reg no.: SHT-2009/003754

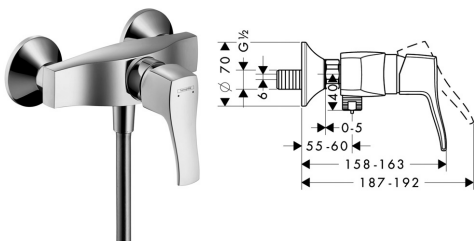

Single Lever Shower Mixer for exposed installation

- connection type: s-shaped connections
- centre distance: 150 mm ± 12 mm
- ceramic cartridge
- temperature limitation adjustable
- non-return valve
- with silencer
- hose connection DN15
- connection dimension: DN15
- MWELS 1 tick & 2 ticks

Code No. 31672000
31672000E
Colour chrome



✓ Good
Water Consumption: 7.50 litres/min
Type of Product: Shower Taps and Mixers
Brand: Hansgrohe
Model: Metris Care Exposed Shower Mixer 31672
Reg no.: SHT-2014/016654



✓✓ Very Good
Water Consumption: 6.50 litres/min
Type of Product: Shower Taps and Mixers
Brand: Hansgrohe
Model: Metris Care Exposed Shower Mixer 31672E
Reg no.: SHT-2014/016655

Basin

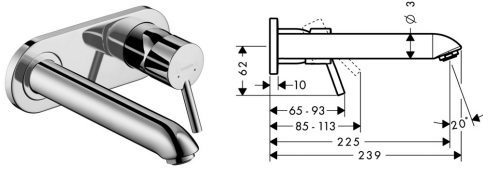

Single Lever Basin Mixer DN15 for concealed installation, with spout 225mm

- ceramic cartridge
 - Boltic lever lock
 - adjustable temperature restriction
 - QuickClean aerator
 - suitable for continuous flow water heaters
- for use with: basic set no. 13622180
- MWELS 1 tick

Code No. 31611000

Colour chrome



✓ Good
 Water Consumption: 4.50 litres/min
 Type of Product: Basin Taps and Mixers
 Brand: Hansgrohe
 Model: Talis S2 Wall Mounted Basin Mixer 225mm Spout31611
 Reg no.: BST-2011/007455

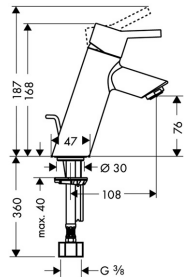

Single Lever Basin Mixer 80 with pop-up waste set

- ComfortZone 80
- normal spray
- ceramic cartridge
- temperature limitation adjustable
- pop-up waste set G 1 1/4"
- suitable for continuous flow water heaters
- connection dimension: DN15
- MWELS 1 tick, 2 ticks & 3 ticks

Code No. 32040000
 32040000E
 32040000L

Colour chrome



✓ Good
 Water Consumption: 4.20 litres/min
 Type of Product: Basin Taps and Mixers
 Brand: Hansgrohe
 Model: Talis 'S' 2
 Reg no.: BST-2009/001681



✓✓ Very Good
 Water Consumption: 3.10 litres/min
 Type of Product: Basin Taps and Mixers
 Brand: Hansgrohe
 Model: Talis S2 basin mixer 32040E
 Reg no.: BST-2013/012168



✓✓✓ Excellent
 Water Consumption: 1.70 litres/min
 Type of Product: Basin Taps and Mixers
 Brand: Hansgrohe
 Model: 32040L
 Reg no.: BST-2014/014300

Basin

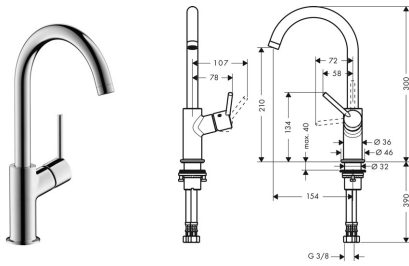

Single Lever Basin Mixer 210 with push-open waste set and fixed spout

- ComfortZone 210
- projection 154 mm
- normal spray
- ceramic cartridge
- temperature limitation adjustable
- pop-up waste set G 1 1/4
- suitable for continuous flow water heaters
- swivel range 120°
- connection dimension: DN15
- MWELS 1 tick & 2 ticks

Code No. 32080000
32080000E
Colour chrome



✓ Good
Water Consumption: 4.80 litres/min
Type of Product: Basin Taps and Mixers
Brand: Hansgrohe
Model: Talis S2 Basin Mixer 210
32080
Registration No.: BST-2015/016745



✓✓ Very Good
Water Consumption: 3.20 litres/min
Type of Product: Basin Taps and Mixers
Brand: Hansgrohe
Model: Talis S2 Basin Mixer 210
32080E
Registration No.: BST-2015/016746

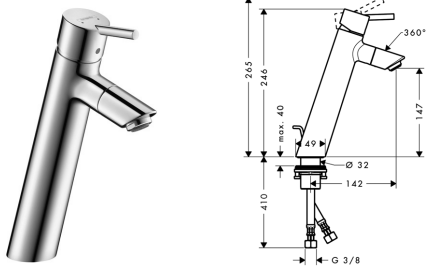

Single Lever Basin Mixer 150 with pop-up waste set

- ComfortZone 150
- normal spray
- projection 142 mm
- ceramic cartridge
- temperature limitation adjustable
- pop-up waste set G 1 1/4"
- suitable for continuous flow water heaters
- connection dimension: DN15
- MWELS 1 tick & 2 ticks

Code No. 32052000
32052000E
Colour chrome



✓ Good
Water Consumption: 4.70 litres/min
Type of Product: Basin Taps and Mixers
Brand: Hansgrohe
Model: 32052
Reg no.: BST-2014/015601



✓✓ Very Good
Water Consumption: 3.10 litres/min
Type of Product: Basin Taps and Mixers
Brand: Hansgrohe
Model: 32052E
Reg no.: BST-2014/015602

Basin

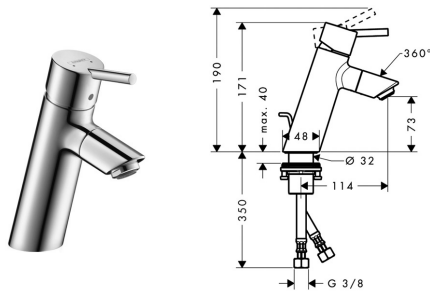

Single Lever Basin Mixer 80 with pop-up waste set

- ComfortZone 80
- normal spray
- ceramic cartridge
- temperature limitation adjustable
- pop-up waste set G 1 1/4
- suitable for continuous flow water heaters
- connection dimension: DN15
- MWELS 1 tick & 2 ticks

Code No. 32053000
32053000E
Colour chrome



✓ Good
Water Consumption: 4.70 litres/min
Type of Product: Basin Taps and Mixers
Brand: Hansgrohe
Model: Talis 80 32053
Reg no.: BST-2014/014525



✓✓ Very Good
Water Consumption: 3.20 litres/min
Type of Product: Basin Taps and Mixers
Brand: Hansgrohe
Model: Talis 80 32053E
Reg no.: BST-2014/014526

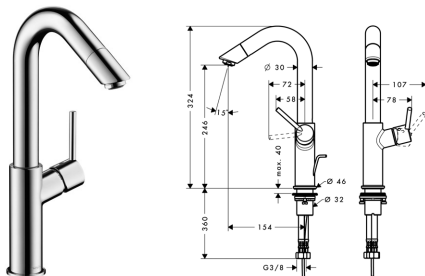

Single Lever Basin Mixer 250 with pop-up waste set

- ComfortZone 250
- projection 154 mm
- normal spray
- ceramic cartridge
- temperature limitation adjustable
- pop-up waste set G 1 1/4
- suitable for continuous flow water heaters
- connection dimension: DN15
- MWELS 1 tick & 2 ticks

Code No. 32055000
32055000E
Colour chrome



✓ Good
Water Consumption: 4.50 litres/min
Type of Product: Basin Taps and Mixers
Brand: Hansgrohe
Model: 32055
Reg no.: BST-2014/015604



✓✓ Very Good
Water Consumption: 2.90 litres/min
Type of Product: Basin Taps and Mixers
Brand: Hansgrohe
Model: 32055E
Reg no.: BST-2014/015605

Basin

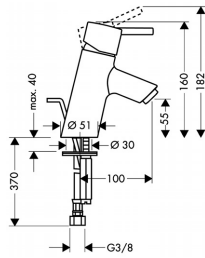

Single Lever Basin Mixer DN15

- ceramic cartridge
- Boltic lever lock
- adjustable temperature restriction
- QuickClean aerator
- pop-up waste set 1 1/4"
- suitable for continuous flow water heaters
- MWELS 1 tick & 2 ticks

Code No. 32020000
3202000E
Colour chrome



✓ **Good**
Water Consumption: 4.50 litres/min
Type of Product: Basin Taps and Mixers
Brand: Hansgrohe
Model: Talis S single lever basin mixer
Reg no.: BST-2009/001719



✓✓ **Very Good**
Water Consumption: 3.70 litres/min
Type of Product: Basin Taps and Mixers
Brand: Hansgrohe
Model: Talis S Single Lever Basin Mixer
32020E
Reg no.: BST-2010/004718

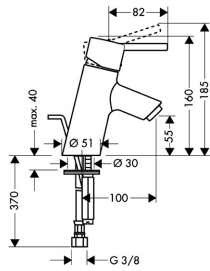

Single Lever Basin Mixer DN15 with extra long handle

- ceramic cartridge
- Boltic lever lock
- adjustable temperature restriction
- QuickClean aerator
- pop-up waste set 1 1/4"
- suitable for continuous flow water heaters
- MWELS 1 tick

Code No. 32034000
Colour chrome



✓ **Good**
Water Consumption: 4.20 litres/min
Type of Product: Basin Taps and Mixers
Brand: Hansgrohe
Model: Talis S Basin Mixer With Long Handle 32034
Reg no.: BST-2009/003762

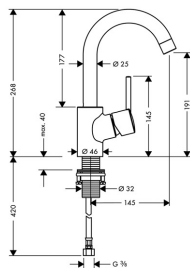

Single Lever Basin Mixer DN15

- connecting hoses G 3/8*
- swivel spout with 360° range
- ceramic cartridge
- adjustable temperature restriction
- QuickClean aerator
- pop-up waste set G 1 1/4"
- suitable for continuous flow water heaters
- MWELS 1 tick

Code No. 32070000
Colour chrome



✓ **Good**
Water Consumption: 4.30 litres/min
Type of Product: Basin Taps and Mixers
Brand: Hansgrohe
Model: Talis S single basin mixer (high spout)
Reg no.: BST-2009/001718

Bath

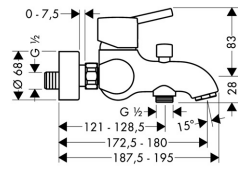

Single Lever Bath Mixer DN15 for exposed fitting

- ceramic cartridge
- Boltic lever lock
- non-return valve, adjustable temperature restriction
- QuickClean aerator
- flow rate 22 l/min.
- button with stop/diverter valve to revert from shower to bath filler
- centre distance 150± 12mm
- S-shaped connections with noise reduction
- NW-6506BT045
- MWELS 1 tick

Code No. 32420000

Colour chrome



✓ Good

Water Consumption: 7.40 litres/min

Type of Product: Shower Taps and Mixers

Brand: Hansgrohe

Model: Talis S Exposed Bath Mixer 32420

Reg no.: SHT-2010/005562

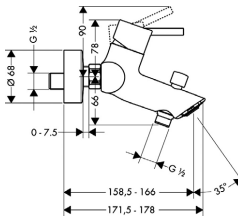

Single Lever Bath Mixer DN15 for exposed fitting

- ceramic cartridge
- Boltic lever lock
- non-return valve
- adjustable temperature restriction
- QuickClean aerator
- button with stop/diverter valve to revert from shower to bath filler
- centre distance 150± 12mm
- S-shaped connections with noise reduction
- MWELS 1 tick

Code No. 32440000

Colour chrome



✓ Good

Water Consumption: 7.50 litres/min

Type of Product: Shower Taps and Mixers

Brand: Hansgrohe

Model: Talis S2 exposed bath mixer

Reg no.: SHT-2009/001555

Shower

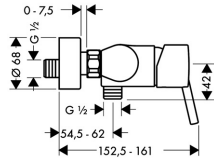

Single Lever Shower Mixer DN15 for exposed fitting

- ceramic cartridge, Boltic lever lock
- non-return valve
- adjustable temperature regulation
- centre distance 150± 12mm
- S-shaped connections with noise reduction
- MWELS 1 tick & 2 ticks

Code No. 32620000
32620000E
Colour chrome



✓ **Good**
Water Consumption: 7.70 litres/min
Type of Product: Shower Taps and Mixers
Brand: Hansgrohe
Model: Talis S Single Lever Exposed Shower Mixer 32620
Reg no.: SHT-2009/003763



✓✓ **Very Good**
Water Consumption: 6.20 litres/min
Type of Product: Shower Taps and Mixers
Brand: Hansgrohe
Model: Talis S Exposed Shower Mixer 32620E
Reg no.: SHT-2010/004522

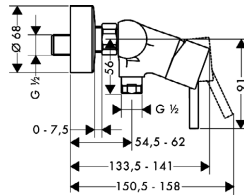

Single Lever Shower Mixer DN15 for exposed fitting

- ceramic cartridge, Boltic lever lock
- non-return valve
- adjustable temperature regulation
- centre distance 150± 12mm
- S-shaped connections with noise reduction
- MWELS 1 tick

Code No. 32640000
Colour chrome



✓ **Good**
Water Consumption: 7.34 litres/min
Type of Product: Shower Taps and Mixers
Brand: Hansgrohe
Model: Talis S2 Exposed Shower Mixer
Reg no.: SHT-2009/001554

Basin

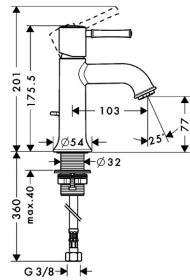

Single Lever Basin Mixer DN15

- ceramic cartridge
- Boltic lever lock
- adjustable temperature restriction
- QuickClean aerator
- pop-up waste set 1 1/4"
- suitable for continuous flow water heaters
- MWELS 1 tick

Code No. 14111000
14111820
Colour chrome
brushed nickel



✓ Good
Water Consumption: 4.30 litres/min
Type of Product: Basin Taps and Mixers
Brand: Hansgrohe
Model: Talis Classic single lever basin mixer
Reg no.: BST-2009/001320

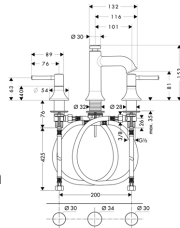

3-hole basin mixer with pop-up waste set

- normal spray
- ceramic valves hot/cold 90°
- pop-up waste set G 1 1/4"
- suitable for continuous flow water heaters
- connection dimension: DN15
- MWELS 1 tick

Code No. 14113000
14113820
14113000E
14113820E
Colour chrome
brushed nickel



✓ Good
Water Consumption: 5.30 litres/min
Type of Product: Basin Taps and Mixers
Brand: Hansgrohe
Model: 14113
Reg no.: BST-2014/015599



✓✓ Very Good
Water Consumption: 3.10 litres/min
Type of Product: Basin Taps and Mixers
Brand: Hansgrohe
Model: 14113E
Reg no.: BST-2014/015600

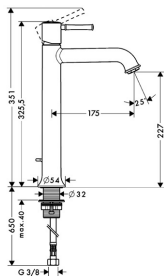

Single Lever Basin Mixer DN15 for wash bowls

- ceramic cartridge
- Boltic lever lock
- adjustable temperature restriction
- QuickClean aerator
- pop-up waste set 1 1/4"
- suitable for continuous flow water heaters
- MWELS 1 tick

Code No. 14116000
14116820
Colour chrome
brushed nickel



✓ Good
Water Consumption: 4.20 litres/min
Type of Product: Basin Taps and Mixers
Brand: Hansgrohe
Model: Talis Classic highriser single lever
Reg no.: BST-2009/001321

Basin

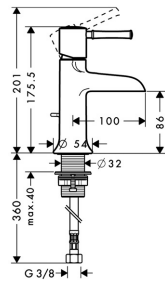

Single Lever Basin Mixer 'Natural' DN15

- ceramic cartridge
- Boltic lever lock
- adjustable temperature restriction
- pop-up waste set 1 1/4"
- suitable for continuous flow water heaters
- MWELS 1 tick

Code No. 14127000
14127820
Colour chrome
brushed nickel



✓ Good
Water Consumption: 4.60 litres/min
Type of Product: Basin Taps and Mixers
Brand: Hansgrohe
Model: Talis Classic (Natural)
Reg no.: BST-2009/001301

Bath

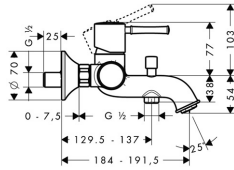

Single Lever Bath Mixer DN15

- ceramic cartridge
- Boltic lever lock
- non-return valve
- adjustable temperature restriction
- QuickClean aerator
- automatically reverts from shower to bath filler
- centre distance 150± 12mm
- S-shaped connections with noise reduction
- MWELS 1 tick

Code No. 14140000
14140820
Colour chrome
brushed nickel



✓ Good
Water Consumption: 7.30 litres/min
Type of Product: Shower Taps and Mixers
Brand: Hansgrohe
Model: Talis Classic Exposed Bath Mixer 14140
Reg no.: SHT-2010/005037

Shower

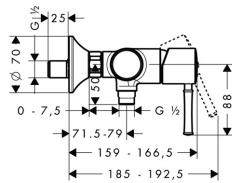

Single Lever Shower Mixer DN15 for exposed installation

- ceramic cartridge
- Boltic lever lock
- non-return valve
- adjustable temperature restriction
- centre distance 150± 12mm
- S-shaped connections with noise reduction
- MWELS 1 tick

Code No. 14161000
14161820
Colour chrome
brushed nickel



✓ Good
Water Consumption: 7.03 litres/min
Type of Product: Shower Taps and Mixers
Brand: Hansgrohe
Model: Talis Classic exposed shower mixer
Reg no.: SHT-2009/001549

Basin

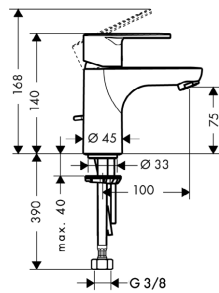

Single Lever Basin Mixer DN15

- ceramic cartridge
- Boltic lever lock
- adjustable temperature restriction
- QuickClean aerator
- pop-up waste set 1 1/4"
- suitable for continuous flow water heaters
- MWELS 1 tick, 2 ticks & 3 ticks

Code No. 31612000
31612000E
31612000L

Colour chrome



✓ **Good**
Water Consumption: 4.20 litres/min
Type of Product: Basin Taps and Mixers
Brand: Hansgrohe
Model: Talis E2 Single Lever Basin Mixer 31612
Reg no.: BST-2009/003437



✓✓ **Very Good**
Water Consumption: 3.00 litres/min
Type of Product: Basin Taps and Mixers
Brand: Hansgrohe
Model: Talis E2 31612E
Reg no.: BST-2013/013701



✓✓✓ **Excellent**
Water Consumption: 1.70 litres/min
Type of Product: Basin Taps and Mixers
Brand: Hansgrohe
Model: Talis E2 31612L
Reg no.: BST-2013/013723

Bath

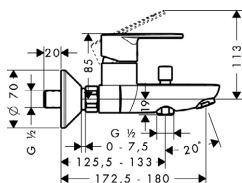
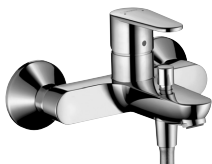

Single Lever Bath Mixer DN15

- ceramic cartridge, Boltic lever lock
- non-return valve
- adjustable temperature restriction
- QuickClean aerator
- button with stop/diverter valve to revert from shower to bath filler
- centre distance 150± 12mm
- S-shaped connections with noise reduction
- MWELS 1 tick, 2 ticks & 3 ticks

Code No. 31642000
31642000E
31642000L

Colour chrome



✓ **Good**
Water Consumption: 7.50 litres/min
Type of Product: Shower Taps and Mixers
Brand: Hansgrohe
Model: Talis E2 31642
Reg no.: SHT-2014/015405



✓✓ **Very Good**
Water Consumption: 6.40 litres/min
Type of Product: Shower Taps and Mixers
Brand: Hansgrohe
Model: Talis E2 31642E
Reg no.: SHT-2014/014522



✓✓✓ **Excellent**
Water Consumption: 4.80 litres/min
Type of Product: Shower Taps and Mixers
Brand: Hansgrohe
Model: Talis E2 31642L
Reg no.: SHT-2014/015407

Shower

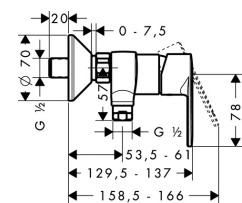

Single Lever Shower Mixer DN15 for exposed fitting

- ceramic cartridge, Boltic lever lock
- non-return valve
- adjustable temperature regulation
- centre distance 150± 12mm
- S-shaped connections with noise reduction
- MWELS 1 tick, 2 ticks & 3 ticks

Code No. 31662000
31662000E
31662000L

Colour chrome



✓ **Good**
Water Consumption: 7.53 litres/min
Type of Product: Shower Taps and Mixers
Brand: Hansgrohe
Model: Talis E2 exposed shower mixer
Reg no.: SHT-2009



✓✓ **Very Good**
Water Consumption: 6.60 litres/min
Type of Product: Shower Taps and Mixers
Brand: Hansgrohe
Model: Talis E2 Exposed Shower Mixer 31662E
Reg no.: SHT-2013/013272



✓✓✓ **Excellent**
Water Consumption: 4.70 litres/min
Type of Product: Shower Taps and Mixers
Brand: Hansgrohe
Model: Talis E2 Exposed Shower Mixer 31662L
Reg no.: SHT-2013/013306

Basin

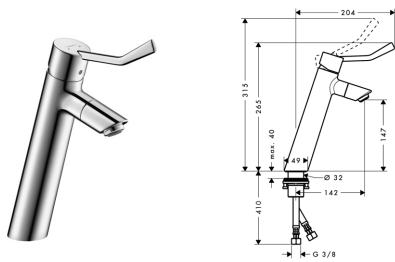

Single Lever Basin Mixer 150 with pop-up waste set and extra long handle

- ComfortZone 150
- user-optimized length of the lever 116 mm
- easy gripping surface through handle design
- rotatable spout 360°
- projection 142 mm
- laminar spray
- ceramic cartridge
- temperature limitation adjustable
- solid brass body, metal handle
- pop-up waste set G 1 1/4
- suitable for continuous flow water heaters
- connection dimension: DN15
- ACS 12 ACC LY 352
- DVGW NW-6506CN0433
- Kiwa K6161_Mechanical Mixers EN817
- MWELS 1 tick & 2 ticks

Code No. 32036000
32036000E
Colour chrome



✓ Good
Water Consumption: 4.80 litres/min
Type of Product: Basin Taps and Mixers
Brand: Hansgrohe
Model: Talis Care Basin Mixer 150
32036
Registration No.: BST-2015/016747



✓✓ Very Good
Water Consumption: 2.90 litres/min
Type of Product: Basin Taps and Mixers
Brand: Hansgrohe
Model: Talis Care Basin Mixer 150
32036E
Registration No.: BST-2015/016748

Bath

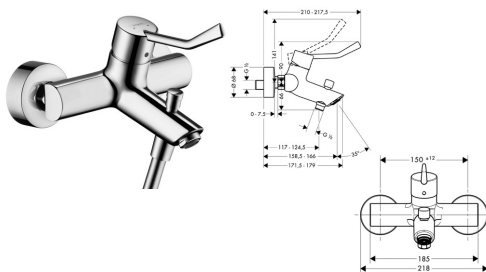

Single lever bath mixer for exposed installation with extra long handle

- projection 158.5 mm - 166 mm
- user-optimized length of the lever 116 mm
- connection type: s-shaped connections
- centre distance: 150 mm ± 12 mm
- ceramic cartridge
- temperature limitation adjustable
- with automatic resetting
- solid brass body, metal handle
- easy gripping surface through handle design
- non-return valve
- with silencer
- suitable for continuous flow water heaters
- connection dimension: DN15
- MWELS 1 tick & 2 ticks

Code No. 32441000
32441000E
Colour chrome



✓ Good
Water Consumption: 8.60 litres/min
Type of Product: Shower Taps and Mixers
Brand: Hansgrohe
Model: Talis Care Exposed Bath Mixer
32441
Reg no.: SHT-2014/016652



✓✓ Very Good
Water Consumption: 6.70 litres/min
Type of Product: Shower Taps and Mixers
Brand: Hansgrohe
Model: Talis Care Exposed Bath Mixer
32441E
Reg no.: SHT-2014/016653

Basin

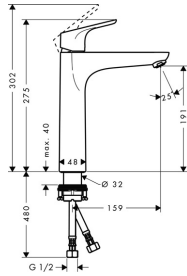

**Single Lever Basin Mixer 190
without waste set**

- ComfortZone 190
- projection 159 mm
- normal spray
- ceramic cartridge
- temperature limitation adjustable
- suitable for continuous flow water heaters
- connection dimension: DN15
- MWELS 1 tick & 2 ticks

Code No. 31518000
31518000E
Colour chrome



✓ Good
Water Consumption: 5.10 litres/min
Type of Product: Basin Taps and Mixers
Brand: Hansgrohe
Model: 31518
Reg no.: BST-2014/016022



✓✓ Very Good
Water Consumption: 3.00 litres/min
Type of Product: Basin Taps and Mixers
Brand: Hansgrohe
Model: 31518E
Reg no.: BST-2014/016023

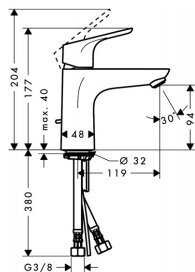

**Single Lever Basin Mixer 100
with pop-up waste set**

- ComfortZone 100
- normal spray
- ceramic cartridge
- temperature limitation adjustable
- pop-up waste set G 1 1/4"
- suitable for continuous flow water heaters
- connection dimension: DN15
- MWELS 2 ticks & 3 ticks

Code No. 31607000E
31607000L
Colour chrome



✓✓ Very Good
Water Consumption: 2.90 litres/min
Type of Product: Basin Taps and Mixers
Brand: Hansgrohe
Model: Focus Basin Mixer 100 31607E
Reg no.: BST-2013/012186



✓✓✓ Excellent
Water Consumption: 1.60 litres/min
Type of Product: Basin Taps and Mixers
Brand: Hansgrohe
Model: Focus 31607L
Reg no.: BST-2014/015006

Basin

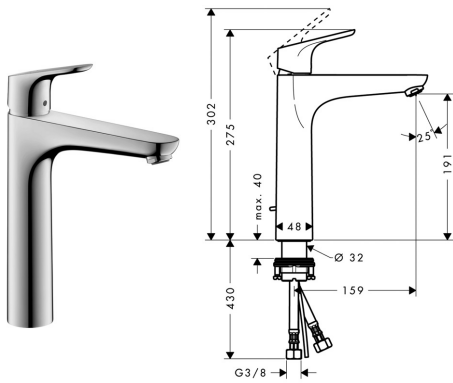

Single Lever Basin Mixer 190 with pop-up waste set

- ComfortZone 190
- normal spray
- ceramic cartridge
- temperature limitation adjustable
- pop-up waste set G 1 1/4"
- suitable for continuous flow water heaters
- connection dimension: DN15
- MWELS 1 tick, 2 ticks & 3 ticks

Code No. 31608000
31608000E
31608000L

Colour chrome



✓ Good
Water Consumption: 4.90 litres/min
Type of Product: Basin Taps and Mixers
Brand: Hansgrohe
Model: Focus Basin Mixer 190 31608
Reg no.: BST-2013/013029



✓✓ Very Good
Water Consumption: 3.00 litres/min
Type of Product: Basin Taps and Mixers
Brand: Hansgrohe
Model: Focus Basin Mixer 190 31608E
Reg no.: BST-2013/013030



✓✓✓ Excellent
Water Consumption: 1.90 litres/min
Type of Product: Basin Taps and Mixers
Brand: Hansgrohe
Model: Focus Basin Mixer 190 31608L
Reg no.: BST-2013/013046

Basin

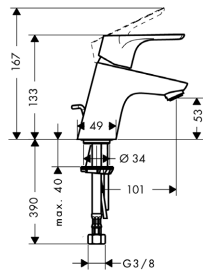

Single Lever Basin Mixer DN15

- ceramic cartridge
- Boltic lever lock
- adjustable temperature restriction
- QuickClean aerator
- pop-up waste set 1 1/4"
- suitable for continuous flow water heaters
- MWELS 1 tick & 3 ticks

Code No. 31730000
31730000L
Colour chrome



✓ Good
Water Consumption: 4.50 litres/min
Type of Product: Basin Taps and Mixers
Brand: Hansgrohe
Model: Focus E2
Reg no.: BST-2009/001678



✓✓✓ Excellent
Water Consumption: 1.50 litres/min
Type of Product: Basin Taps and Mixers
Brand: Hansgrohe
Model: Focus E2 Single Lever Basin Mixer 31730L
Reg no.: BST-2011/008269

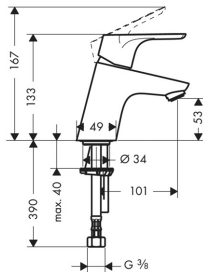

Single Lever Basin Mixer 70, DN15

- ComfortZone 70
- without waste set
- ceramic cartridge
- Boltic lever lock
- adjustable temperature restriction
- QuickClean aerator
- suitable for continuous flow water heaters
- MWELS 1 tick, 2 ticks & 3 ticks

Code No. 31733000
31733000E
31733000L
Colour chrome



✓ Good
Water Consumption: 4.60 litres/min
Type of Product: Basin Taps and Mixers
Brand: Hansgrohe
Model: Focus E2 Basin Mixer without Pull Rod 31733
Reg no.: BST-2013/012226



✓✓ Very Good
Water Consumption: 3.00 litres/min
Type of Product: Basin Taps and Mixers
Brand: Hansgrohe
Model: Focus E2 Basin Mixer without Pull Rod 31733E
Reg no.: BST-2013/012227



✓✓✓ Excellent
Water Consumption: 1.70 litres/min
Type of Product: Basin Taps and Mixers
Brand: Hansgrohe
Model: 31733L
Reg no.: BST-2015/017305

Bath

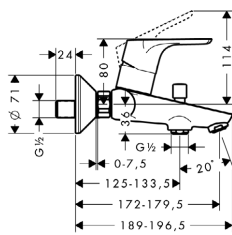

Single Lever Bath Mixer DN15 for exposed fitting

- ceramic cartridge, Boltic lever lock
- non-return valve, QuickClean aerator
- adjustable temperature restriction
- button with stop/diverter valve to revert from shower to bath filler
- centre distance 150± 12mm
- S-shaped connections with noise reduction
- MWELS 1 tick & 3 ticks

Code No. 31940000
31940000L
Colour chrome



✓ Good
Water Consumption: 7.86 litres/min
Type of Product: Shower Taps and Mixers
Brand: Hansgrohe
Model: Focus E2 exposed bath mixer
Reg no.: SHT-2009/001548



✓✓✓ Excellent
Water Consumption: 5.00 litres/min
Type of Product: Shower Taps and Mixers
Brand: Hansgrohe
Model: 31940L
Reg no.: SHT-2013/014053

Shower

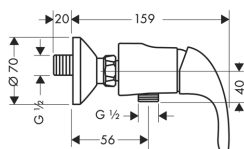

Single Lever Shower Mixer for exposed installation

- 1 outlet
- connection type: s-shaped connections
- centre distance: 150 mm ± 12 mm
- ceramic cartridge
- temperature limitation adjustable
- non-return valve
- with silencer
- hose connection DN15
- connection dimension: DN15
- MWELS 1 tick, 2 ticks & 3 ticks

Code No. 31760000
31760000E
31760000L
Colour chrome



✓ Good
Water Consumption: 7.74 litres/min
Type of Product: Shower Taps and Mixers
Brand: Hansgrohe
Model: Focus E exposed shower mixer
Reg no.: SHT-2009/001552



✓✓ Very Good
Water Consumption: 6.70 litres/min
Type of Product: Shower Taps and Mixers
Brand: Hansgrohe
Model: Focus E 31760E
Reg no.: SHT-2014/015005



✓✓✓ Excellent
Water Consumption: 4.90 litres/min
Type of Product: Shower Taps and Mixers
Brand: Hansgrohe
Model: Focus E31760L
Reg no.: SHT-2014/014861

Shower

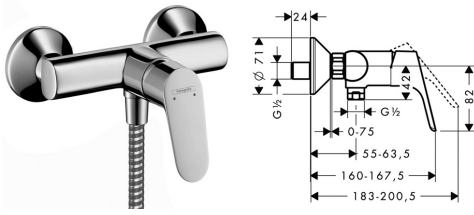

Single Lever Shower Mixer DN15 for exposed fitting

- ceramic cartridge
- Boltic lever lock
- adjustable temperature restriction
- centre distance 150 ± 12 mm
- S-shaped connections with noise reduction
- MWELS 1 tick

Code No. 31960000

Colour chrome



✓ Good

Water Consumption: 7.37 litres/min

Type of Product: Shower Taps and Mixers

Brand: Hansgrohe

Model: Focus E2 exposed shower mixer

Reg no.: SHT-2009/001547

Bath

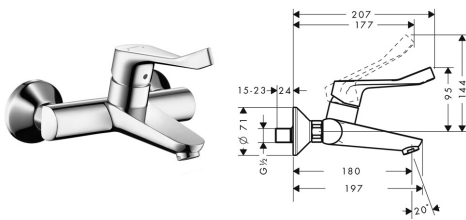

Single lever basin Mixer for exposed installation with extra long handle

- user-optimized length of the lever 121 mm
- easy gripping surface through handle design
- projection 180 mm
- centre distance: 150 mm ± 12 mm
- ceramic cartridge
- temperature limitation adjustable
- smooth surfaces
- solid brass body, metal handle
- non-return valve
- with noise reduction
- suitable for continuous flow water heaters
- connection dimension: DN15
- MWELS 1 tick & 2 ticks

Code No. 31913000
31913000E
Colour chrome



✓ Good
Water Consumption: 4.40 litres/min
Type of Product: Basin Taps and Mixers
Brand: Hansgrohe
Model: 31913
Reg no.: BST-2015/017744



✓✓ Very Good
Water Consumption: 2.40 litres/min
Type of Product: Basin Taps and Mixers
Brand: Hansgrohe
Model: 31913E
Reg no.: BST-2015/017745

Shower

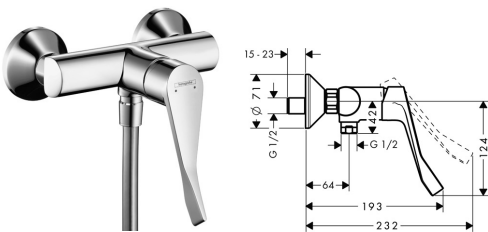

Single lever shower mixer for exposed installation with extra long handle

- user-optimized length of the lever 121 mm
- connection type: s-shaped connections
- centre distance: 150 mm ± 12 mm
- ceramic cartridge
- temperature limitation adjustable
- smooth surfaces
- solid brass body, metal handle
- easy gripping surface through handle design
- non-return valve
- with silencer
- hose connection DN15
- connection dimension: DN15
- MWELS 1 tick & 2 ticks

Code No. 31916000
31916000E
Colour chrome



✓ Good
Water Consumption: 7.30 litres/min
Type of Product: Shower Taps and Mixers
Brand: Hansgrohe
Model: 31916
Reg no.: SHT-2015/017733



✓✓ Very Good
Water Consumption: 5.30 litres/min
Type of Product: Shower Taps and Mixers
Brand: Hansgrohe
Model: 31916E
Reg no.: SHT-2015/017734

Basin

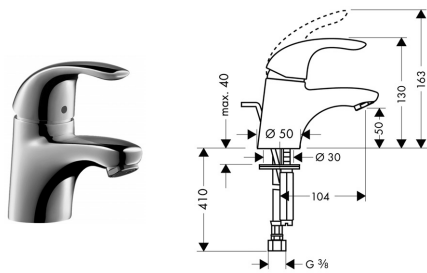

Single Lever Basin Mixer DN15

- ceramic cartridge
- Boltic lever lock
- adjustable temperature restriction
- QuickClean aerator
- pop-up waste set 1 1/4"
- suitable for continuous flow water heaters
- MWELS 1 tick, 2 ticks & 3 ticks

Code No. 31700000
31700000E
31700000L
Colour chrome



✓ **Good**
Water Consumption: 4.30 litres/min
Type of Product: Basin Taps and Mixers
Brand: Hansgrohe
Model: Focus E single lever basin mixer
Reg no.: BST-2009/001713



✓✓ **Very Good**
Water Consumption: 3.10 litres/min
Type of Product: Basin Taps and Mixers
Brand: Hansgrohe
Model: Focus E Basin Mixer 31700E
Reg no.: BST-2013/013431



✓✓✓ **Excellent**
Water Consumption: 1.90 litres/min
Type of Product: Basin Taps and Mixers
Brand: Hansgrohe
Model: Focus E Basin Mixer 31700L
Reg no.: BST-2013/013502

Bath

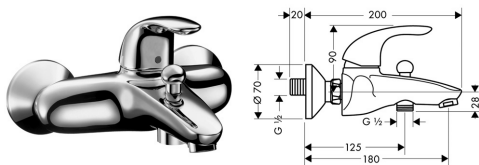

Single Lever Bath Mixer DN15 for exposed fitting

- ceramic cartridge, Boltic lever lock
- non-return valve
- QuickClean aerator
- adjustable temperature restriction
- button with stop/diverter valve to revert from shower to bath filler
- centre distance 150± 12mm
- S-shaped connections with noise reduction
- MWELS 1 tick & 2 ticks

Code No. 31740000
31740000E
Colour chrome



✓ **Good**
Water Consumption: 8.07 litres/min
Type of Product: Shower Taps and Mixers
Brand: Hansgrohe
Model: Focus E exposed bath mixer
Reg no.: SHT-2009/001553



✓✓ **Very Good**
Water Consumption: 5.50 litres/min
Type of Product: Shower Taps and Mixers
Brand: Hansgrohe
Model: Focus Exposed Bath Mixer 31740E
Reg no.: SHT-2013/013438

Shower

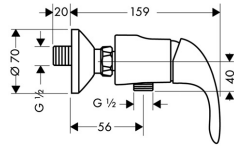

Single Lever Shower Mixer for exposed fitting DN15

- ceramic cartridge
- Boltic lever lock
- adjustable temperature restriction
- non-return valve
- centre distance 150± 12mm
- S-shaped connections with noise reduction
- MWELS 1 tick & 2 ticks

Code No. 31760000
31760000E
31760000L
Colour chrome



✓ Good
Water Consumption: 7.74 litres/min
Type of Product: Shower Taps and Mixers
Brand: Hansgrohe
Model: Focus E exposed shower mixer
Reg no.: SHT-2009/001552



✓✓ Very Good
Water Consumption: 6.70 litres/min
Type of Product: Shower Taps and Mixers
Brand: Hansgrohe
Model: Focus E 31760E
Reg no.: SHT-2014/015005



✓✓✓ Excellent
Water Consumption: 4.90 litres/min
Type of Product: Shower Taps and Mixers
Brand: Hansgrohe
Model: Focus E 31760L
Reg no.: SHT-2014/014861

Basin

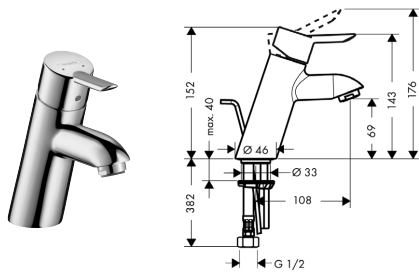

Single Lever Basin Mixer DN15

- ceramic cartridge
- Boltic lever lock
- adjustable temperature restriction
- QuickClean aerator
- pop-up waste set 1 1/4"
- suitable for continuous flow water heaters
- MWELS 1 tick & 2 ticks

Code No. 31701000
31701000E
Colour chrome



✓ Good
Water Consumption: 4.50 litres/min
Type of Product: Basin Taps and Mixers
Brand: Hansgrohe
Model: Focus S single lever basin mixer
Reg no.: BST-2009/001714



✓✓ Very Good
Water Consumption: 3.50 litres/min
Type of Product: Basin Taps and Mixers
Brand: Hansgrohe
Model: Focus S Single Lever Basin Mixer 31701E
Reg no.: BST-2010/004717

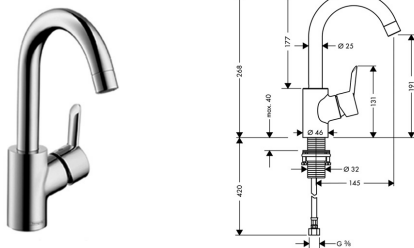

Single Lever Basin Mixer DN15

- swivel spout with 360° range
- ceramic cartridge
- adjustable temperature restriction
- QuickClean aerator
- pop-up waste set G 1 1/4"
- suitable for continuous flow water heaters
- MWELS 1 tick

Code No. 31710000
Colour chrome



✓ Good
Water Consumption: 4.80 litres/min
Type of Product: Basin Taps and Mixers
Brand: Hansgrohe
Model: Focus S High Spout Basin Mixer 31710
Reg no.: BST-2010/006751

Bath

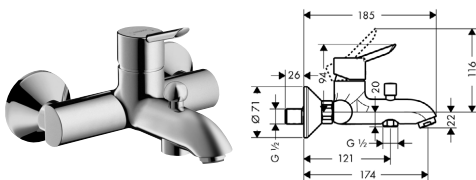

Single Lever Bath Mixer DN15 for exposed fitting

- ceramic cartridge, Boltic lever lock
- non-return valve
- adjustable temperature restriction
- QuickClean aerator
- button with stop/diverter valve to revert from shower to bath filler
- centre distance 150± 12mm
- S-shaped connections with noise reduction
- MWELS 1 tick

Code No. 31742000
Colour chrome



✓ Good
Water Consumption: 7.31 litres/min
Type of Product: Shower Taps and Mixers
Brand: Hansgrohe
Model: Focus S exposed bath mixer
Reg no.: SHT-2009/001551

Shower

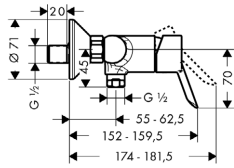
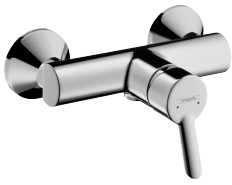

Single Lever Shower Mixer DN15 for exposed fitting

- ceramic cartridge
- Boltic lever lock
- adjustable temperature regulation
- non-return valve
- centre distance 150± 12mm
- S-shaped connections with noise reduction
- MWELS 1 tick & 2 ticks

Code No. 31762000
31762000E
Colour chrome



✓ Good
Water Consumption: 7.41 litres/min
Type of Product: Shower Taps and Mixers
Brand: Hansgrohe
Model: Focus S exposed shower mixer
Reg no.: SHT-2009/001550



✓✓ Very Good
Water Consumption: 6.70 litres/min
Type of Product: Shower Taps and Mixers
Brand: Hansgrohe
Model: 31762E
Reg no.: SHT-2015/017782

Basin

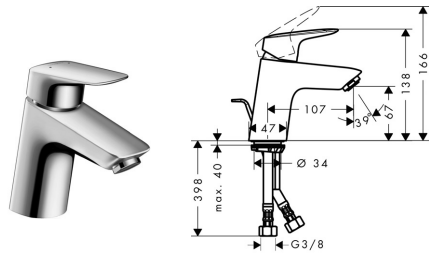

Single Lever Basin Mixer 70 with pop-up waste set

- ComfortZone 70
- normal spray
- ceramic cartridge
- temperature limitation adjustable
- pop-up waste set G 1 1/4"
- suitable for continuous flow water heaters
- connection dimension: DN15
- MWELS 1 tick & 2 ticks

Code No. 71070000
71070000E
Colour chrome



✓ Good
Water Consumption: 4.80 litres/min
Type of Product: Basin Taps and Mixers
Brand: Hansgrohe
Model: 71070009
Reg no.: BST-2014/014473



✓✓ Very Good
Water Consumption: 3.40 litres/min
Type of Product: Basin Taps and Mixers
Brand: Hansgrohe
Model: 71070019
Reg no.: BST-2014/014474

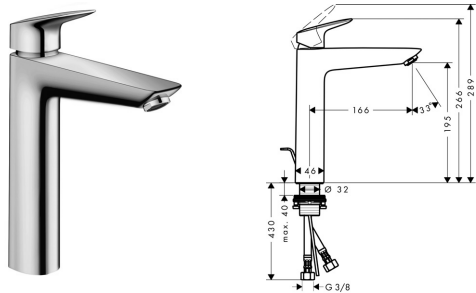

Single Lever Basin Mixer 190 with pop-up waste set

- ComfortZone 190
- projection 166 mm
- normal spray
- ceramic cartridge
- temperature limitation adjustable
- pop-up waste set G 1 1/4"
- suitable for continuous flow water heaters
- connection dimension: DN15
- MWELS 1 tick & 2 ticks

Code No. 71090000
71090000E
Colour chrome



✓ Good
Water Consumption: 5.80 litres/min
Type of Product: Basin Taps and Mixers
Brand: Hansgrohe
Model: 71090000
Reg no.: BST-2014/015603



✓✓ Very Good
Water Consumption: 2.40 litres/min
Type of Product: Basin Taps and Mixers
Brand: Hansgrohe
Model: 71090E
Reg no.: BST-2015/017746

Basin

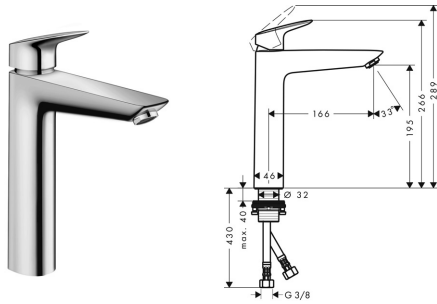

**Single lever basin mixer 190
without waste set**

- ComfortZone 190
- projection 166 mm
- normal spray
- ceramic cartridge
- temperature limitation adjustable
- pop-up waste set G 1 1/4
- suitable for continuous flow water heaters
- connection dimension: DN15
- MWELS 1 tick & 2 ticks

Code No. 71091000
71091000E
Colour chrome



✓ Good
Water Consumption: 4.20 litres/min
Type of Product: Basin Taps and Mixers
Brand: Hansgrohe
Model: 71091
Reg no.: BST-2015/017731



✓✓ Very Good
Water Consumption: 2.20 litres/min
Type of Product: Basin Taps and Mixers
Brand: Hansgrohe
Model: 71091E
Reg no.: BST-2015/017732

Bath

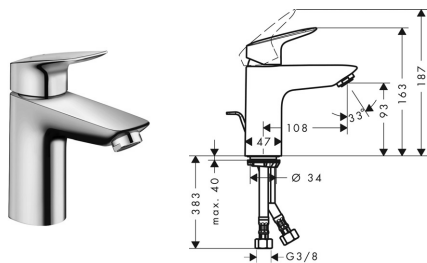

**Single Lever Bath Mixer 100
with pop-up waste set**

- ComfortZone 100
- normal spray
- ceramic cartridge
- temperature limitation adjustable
- pop-up waste set G 1 1/4"
- suitable for continuous flow water heaters
- connection dimension: DN15
- MWELS 2 ticks

Code No. 71100000E
Colour chrome



✓✓ Very Good
Water Consumption: 3.20 litres/min
Type of Product: Basin Taps and Mixers
Brand: Hansgrohe
Model: 71100019
Reg no.: BST-2014/014476

Basin

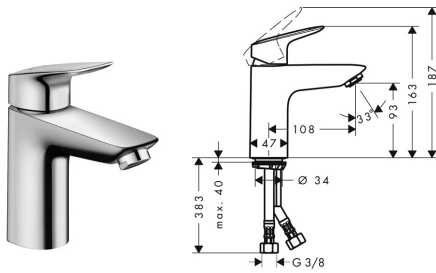

Single lever basin mixer 100 without waste set

- ComfortZone 70
- projection 108 mm
- normal spray
- ceramic cartridge
- temperature limitation adjustable
- pop-up waste set G 1 1/4
- suitable for continuous flow water heaters
- connection dimension: DN15
- MWELS 1 tick & 2 ticks

Code No. 71101000
71101000E
Colour chrome



✓ Good
Water Consumption: 4.30 litres/min
Type of Product: Basin Taps and Mixers
Brand: Hansgrohe
Model: 71101
Reg no.: BST-2015/017735



✓✓ Very Good
Water Consumption: 2.20 litres/min
Type of Product: Basin Taps and Mixers
Brand: Hansgrohe
Model: 71101E
Reg no.: BST-2015/017736

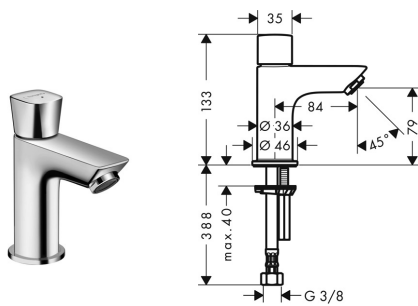

Pillar top 70 without waste set

- ComfortZone 70
- projection 84mm
- normal spray
- ceramic valves 90°
- for cold water connection
- without waste set
- connection dimension: DN15
- MWELS 1 tick & 2 ticks

Code No. 71120000
71120000E
Colour chrome



✓ Good
Water Consumption: 4.40 litres/min
Type of Product: Basin Taps and Mixers
Brand: Hansgrohe
Model: 71120
Reg no.: BST-2015/017729



✓✓ Very Good
Water Consumption: 2.40 litres/min
Type of Product: Basin Taps and Mixers
Brand: Hansgrohe
Model: 71120E
Reg no.: BST-2015/017730

Basin

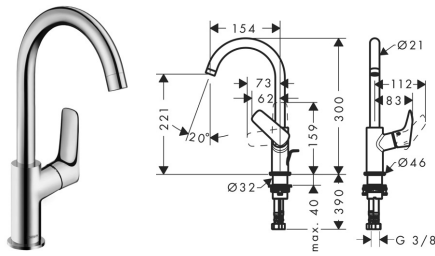

Single Lever Basin Mixer 210 with swivel spout with 120° range and pop-up waste set

- ComfortZone 210
- projection 154 mm
- normal spray
- ceramic cartridge
- temperature limitation adjustable
- pop-up waste set G 1 1/4
- suitable for continuous flow water heaters
- swivel range 120°
- connection dimension: DN15
- MWELS 1 tick & 2 ticks

Code No. 71130000
71130000E
Colour chrome



✓ Good
Water Consumption: 4.80 litres/min
Type of Product: Basin Taps and Mixers
Brand: Hansgrohe
Model: 71130
Registration No.: BST-2015/016959



✓✓ Very Good
Water Consumption: 3.30 litres/min
Type of Product: Basin Taps and Mixers
Brand: Hansgrohe
Model: 71130E
Registration No.: BST-2015/016958

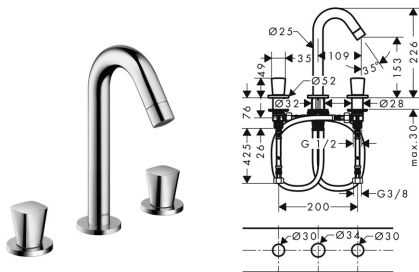

3-hole basin mixer with pop-up waste set

- ComfortZone 150
- projection 109 mm
- ceramic valves hot/ cold 90°
- scope of supply: basic and finish set
- pop-up waste set G 1 1/4
- suitable for continuous flow water heaters
- connection dimension: DN15
- MWELS 1 tick, 2 ticks & 3 ticks

Code No. 71133000
71133000E
71133000L
Colour chrome



✓ Good
Water Consumption: 5.80 litres/min
Type of Product: Basin Taps and Mixers
Brand: Hansgrohe
Model: 71133
Registration No.: BST-2015/017308



✓✓ Very Good
Water Consumption: 3.20 litres/min
Type of Product: Basin Taps and Mixers
Brand: Hansgrohe
Model: 71133E
Registration No.: BST-2015/017309



✓✓✓ Excellent
Water Consumption: 1.70 litres/min
Type of Product: Basin Taps and Mixers
Brand: Hansgrohe
Model: 71133L
Registration No.: BST-2015/017310

Bath

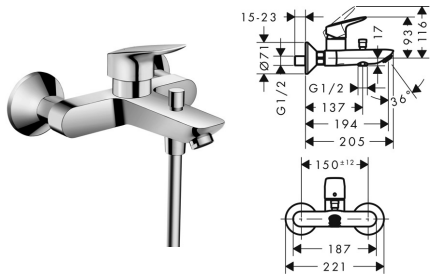

Single Lever Bath Mixer for exposed installation

- projection 194 mm
- connection type: s-shaped connections
- centre distance: 150 mm ± 12 mm
- normal spray
- ceramic cartridge
- temperature limitation adjustable
- with automatic resetting
- non-return valve
- with silencer
- suitable for continuous flow water heaters
- connection dimension: DN15
- MWELS 2 ticks

Code No. 7140000E

Colour chrome



✓✓ Very Good
 Water Consumption: 6.50 litres/min
 Type of Product: Shower Taps and Mixers
 Brand: Hansgrohe
 Model: Logis 71400E
 Registration No.: SHT-2015/016865

Shower

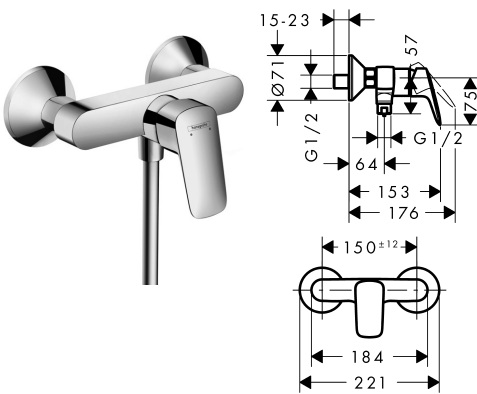

Single Lever Shower Mixer for exposed installation

- connection type: s-shaped connections
- centre distance 150mm ± 12mm
- ceramic cartridge
- temperature limitation adjustable
- non-return valve
- with silencer
- hose connection DN15
- connection dimensions: DN15
- MWELS 2 ticks

Code No. 7160000E

Colour chrome



✓✓ Very Good
 Water Consumption: 5.60 litres/min
 Type of Product: Shower Taps and Mixers
 Brand: Hansgrohe
 Model: Logis Exposed Shower Mixer 71600E
 Reg no.: SHT-2014/016656

Basin

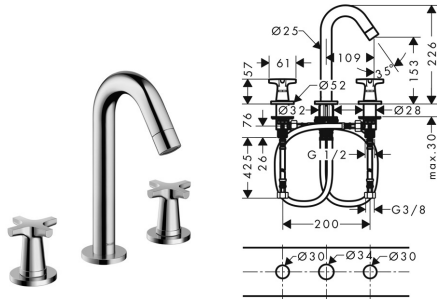

3-hole basin Mixer with pop-up waste set

- ComfortZone 150
- ceramic valves hot/ cold 90°
- scope of supply: basic and finish set
- pop-up waste set G 1/4
- suitable for continuous flow water heaters
- connection dimension: DN15
- MWELS 1 tick & 2 ticks

Code No. 71323000
71323000E
Colour chrome



✓ Good
Water Consumption: 4.50 litres/min
Type of Product: Basin Taps and Mixers
Brand: Hansgrohe
Model: 71323
Reg no.: BST-2015/017738



✓✓ Very Good
Water Consumption: 2.50 litres/min
Type of Product: Basin Taps and Mixers
Brand: Hansgrohe
Model: 71323E
Reg no.: BST-2015/017739

Shower

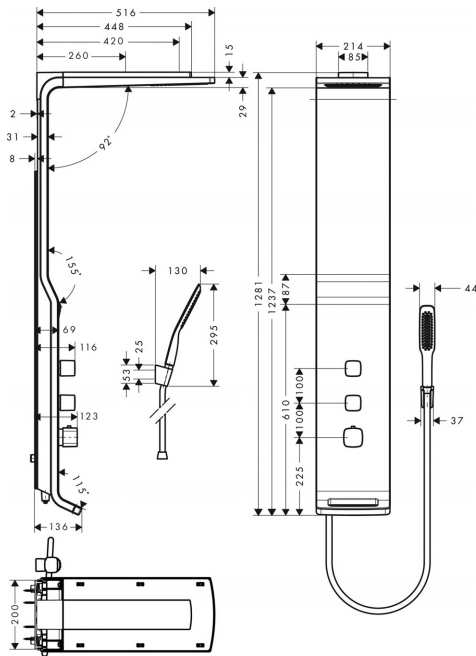

Code No. 27008000
27008400
Colour satin chrome
white chrome

Raindance Lift 180 2jet Shower Panel for exposed installation

- overhead shower Raindance 240 Air
- shower head size: 240mm
- shower arm length: 420mm
- height adjustment: 200mm
- spray type (overhead shower): RainAir, wide flood jet
- scald protection at 40°
- adjustable hot water limitation
- isolated water conduction
- outlets controled via turning handle
- centre distance: 150mm ± 12mm
- connection thread G 1/2
- site: wall
- installation type: exposed installation
- connection dimension: DN15

consisting of:

- Porter'S shower holder (no.28331XXX)
- Isiflex shower hose 1.60m (no.28276XXX)
- PuraVida 120 Air 1 jet baton hand shower (no.28558XXX)
- MWELS 1 tick



✓ Good
Water Consumption: 8.10 litres/min
Type of Product: Shower Taps and Mixers
Brand: Hansgrohe
Model: Raindance Lift Shower Panel 27008
Reg no.: SHT-2013/013220

Shower

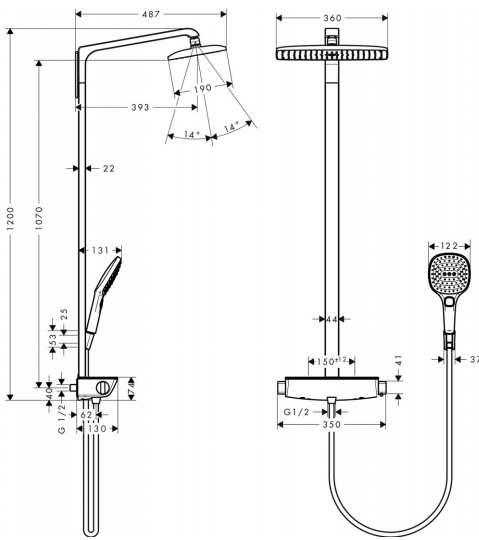

Code No. 27112000
27112400
Colour chrome
white chrome

Raindance Select 360 Showerpipe, DN15

consisting of

- overhead shower Raindance E Air 1jet, 360 x 190mm with ball-joint, AirPower technology and QuickClean
- shower arm 380mm
- hand shower Raindance Select 150 3jet DN15 (no.28587xxx)
- shower holder Porter'S (no.28331000)
- Isiflex shower hose 1.60m DN15 (no.28276000)
- thermostat with safety stop at 40°C:
 - pre-adjustable hot water restriction
 - shut-off/ diverter valve for overhead/ hand shower
 - housing in chrome with isolated water conduction
 - centre distance 150mm ± 12mm
- safety glass shelf, available in two colours
- wall bar spacer 8mm (no.95960000)
- MWELS 1 tick

Colour of shelf:

- ,000: shelf with reflective chrome coating
- ,400: shelf with white coating



✓ Good

Water Consumption: 7.80 litres/min

Type of Product: Shower Taps and Mixers

Brand: Hansgrohe

Model: Raindance Select 360 with Thermostatic 27112

Reg no.: SHT-2013/012169

Shower

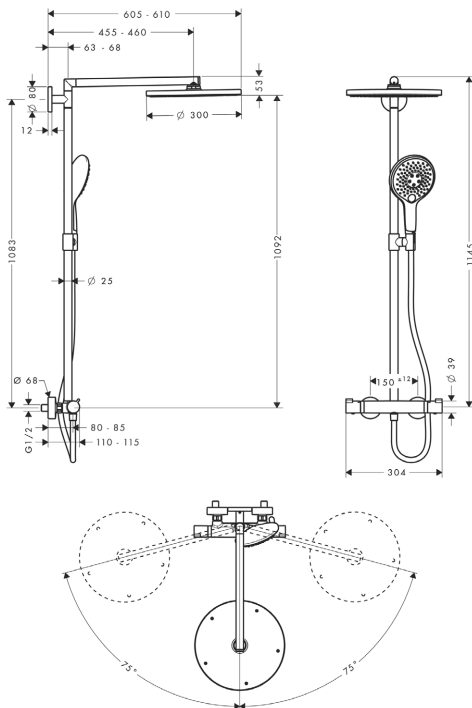

Code No. 27114000

Colour chrome

Raindance Select 300 Showerpipe, DN15

consisting of

- overhead shower Raindance Air Ø300mm with AirPower technology and QuickClean
- shower arm 450mm, swivelling
- hand shower Raindance Select 150 3jet DN15 (no.28587000)
- shower holder, height adjustable
- Isiflex shower hose 1.60m DN15 (no.28276000)
- thermostat with safety stop at 40 °C:
 - pre-adjustable hot water restriction
 - shut-off/ diverter valve for overhead shower/ hand shower
 - centre distance 150mm ± 12mm
- with wall bar spacer 8mm (no.98681000)
- MWELS 1 tick



✓ Good

Water Consumption: 8.30 litres/min

Type of Product: Shower Taps and Mixers

Brand: Hansgrohe

Model: Raindance Select 300 Showerpipe Thermostat 27114

Reg no.: SHT-2013/012583

Shower



Code No. 27115000

Colour chrome

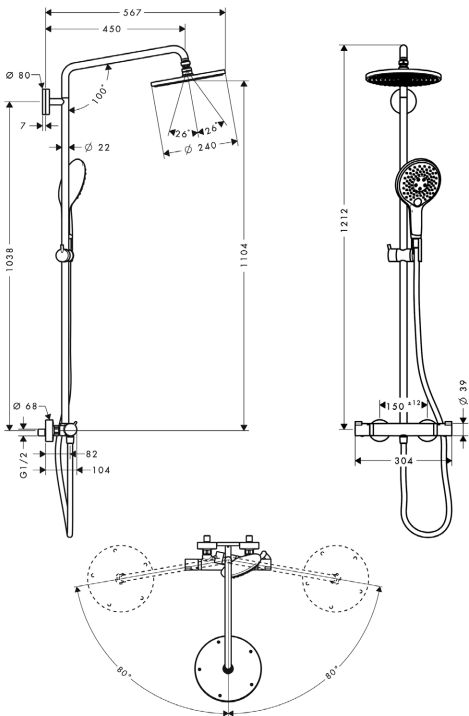

Raindance Select 240 Showerpipe, DN15

consisting of

- overhead shower Raindance Air Ø240mm with AirPower technology and QuickClean
- shower arm 450mm, swivelling
- hand shower Raindance Select 150 3jet DN15 (no.28587000)
- shower holder, height adjustable
- Isiflex shower hose 1.60m DN15 (no.28276000)
- thermostat with safety stop at 40 °C:
 - pre-adjustable hot water restriction
 - shut-off/ diverter valve for overhead shower/ hand shower
 - centre distance 150mm ± 12mm
- with wall bar spacer 8mm (no.98681000)
- MWELS 1 tick



✓ Good

Water Consumption: 8.40 litres/min

Type of Product: Shower Taps and Mixers

Brand: Hansgrohe

Model: Raindance Select 240 with Thermostat 27115

Reg no.: SHT-2013/012582

Shower

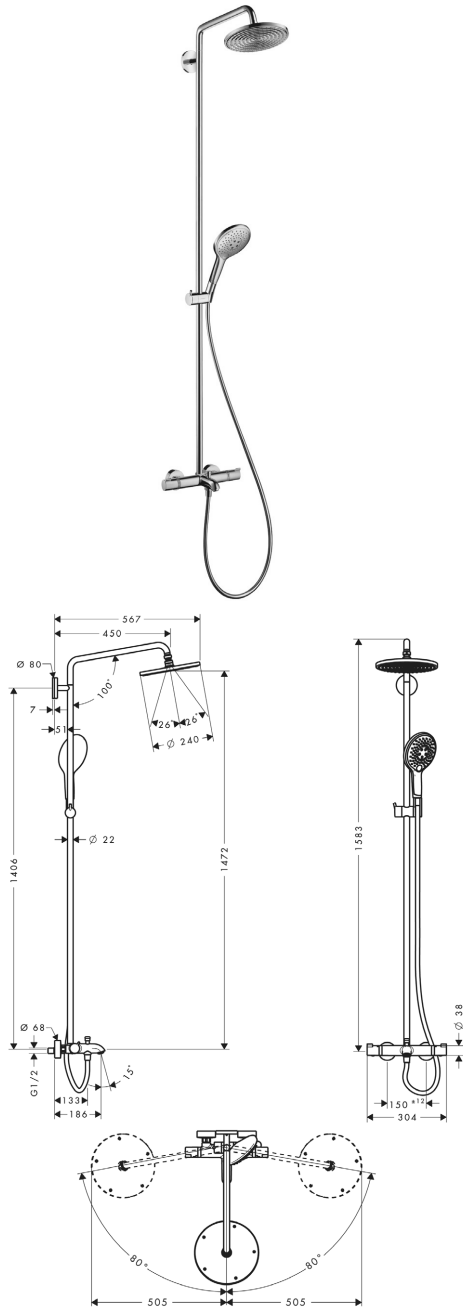

Code No. 27117000
Colour chrome

Raindance Select 240 Showerpipe for bath tub, DN15

consisting of

- Raindance Air overhead shower Ø240mm with AirPower technology and QuickClean anti-limescale system
- shower arm 450mm swivelling
- Raindance Select 150 3jet hand shower DN15 (no.28586000)
- height adjustable shower holder
- Isiflex shower hose 1.60m DN15 (no.28276000)
- thermostat with safety stop at 40 °C:
 - pre-adjustable hot water restriction
 - shut-off/ diverter valve for overhead shower/ bath filler
 - diverter for hand shower (adjustable)
 - centre distance 150mm ± 12mm
- including 8mm wall bar spacer (no.98681000)
- MWELS 1 tick



✓ Good
 Water Consumption: 8.70 litres/min
 Type of Product: Shower Taps and Mixers
 Brand: Hansgrohe
 Model: Raindance select 240 with Thermostat 27117
 Reg no.: SHT-2013/012581

Shower

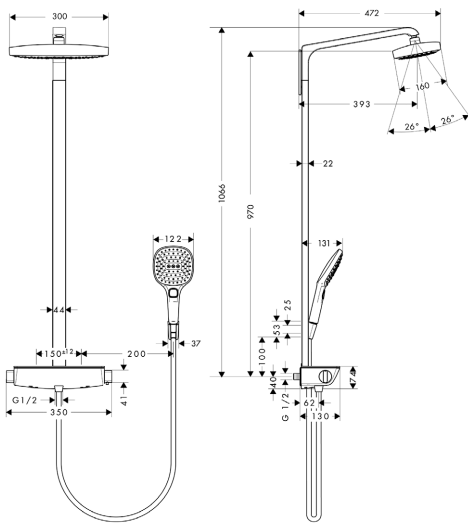

Raindance Select E 300 2jet Showerpipe

- overhead shower
- Raindance Select E 300 2jet
- shower head size: 300 x 160mm
- overhead shower angle adjustable
- spray type: Rain, RainAir
- convenient diversion via Select button
- spray disc surface in two variants: chrome or white
- shower arm length: 380mm
- thermostat Ecostat Select
- with spacious shelf
- shelf finish: chrome or white
- isolated water conduction
- safety lock at 40°C
- adjustable hot water limitation
- outlets controled via turning handle
- installation type: exposed installation
- connection dimension DN15
- connection thread G 1/2
- centre distance 150mm ± 12mm
- in case of installation on existing G 1/2 connections, adaptor no. 02026000 must be used

consisting of:

- Raindance Select E 120 3jet hand shower (no.26520XXX)
- Porter'S shower holder (no.28331XXX)
- Isiflex shower hose 1.60m (no.28276XXX)
- Wall bar spacer for Raindance Select (no.95960000)
- MWELS 1 tick

Code No. 27128000
27128400
Colour chrome
white chrome



✓ Good

Water Consumption: 7.90 litres/min

Type of Product: Shower Taps and Mixers

Brand: Hansgrohe

Model: Raindance Select E300 2 Jet Showerpipe 27128

Reg no.: SHT-2013/013274

Showerpipe

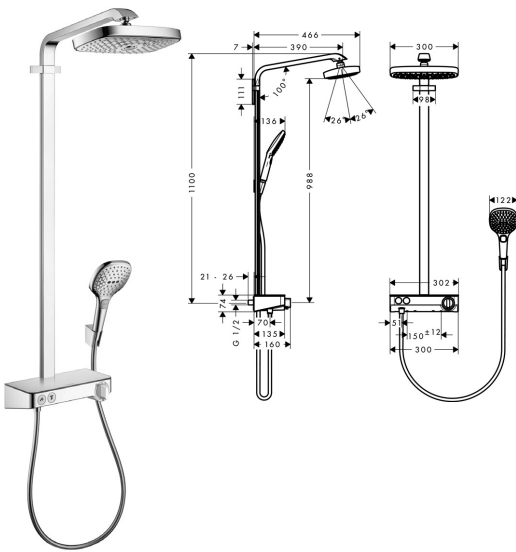

Code No. 27126000
27126400
Colour chrome

Raindance Select E 300 2jet ST Showerpipe

- overhead shower Raindance Select E 300 2jet
- shower head size: 300 x 160 mm
- overhead shower angle adjustable
- spray type: RainAir, Rain
- convenient diversion via Select button
- spray disc surface in two variants: chrome or white
- shower arm length: 380 mm
- thermostat ShowerTablet 300
- with spacious shelf
- shelf finish: chrome or white
- isolated water conduction
- safety lock at 40° C
- adjustable hot water limitation
- convenient diversion via Select button
- installation type: exposed installation
- connection dimension DN15
- connection thread G 1/2"
- centre distance 150 mm ± 12 mm
- in case of installation on existing G 1/2" connections, adaptor no. 02026000 must be used
- operating pressure min. 1.5 bar / max. 10 bar
- MWELS 1 tick



✓ Good
Water Consumption: 7.10 litres/min
Type of Product: Shower Taps and Mixers
Brand: Hansgrohe
Model: Raindance Select E300 Showerpipe 27126
Reg no.: SHT-2014/016121

Showerpipe

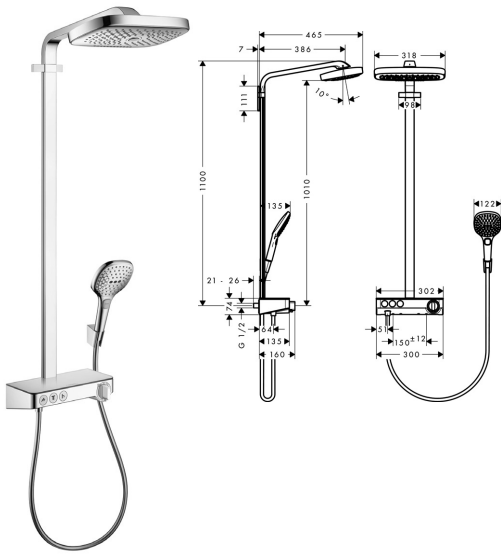

Code No. 27127000
27127400
Colour chrome

Raindance Select E 300 3jet ST Showerpipe

- overhead shower Raindance Select E 300 3jet
- shower head size: 300 x 190 mm
- spray type: RainAir, Rain, RainStream
- convenient diversion via Select button
- spray disc surface in two variants: chrome or white
- shower arm length: 380 mm
- thermostat ShowerTablet 300
- with spacious shelf
- shelf finish: chrome or white
- isolated water conduction
- safety lock at 40° C
- adjustable hot water limitation
- convenient diversion via Select button
- installation type: exposed installation
- connection dimension DN15
- connection thread G 1/2"
- centre distance 150 mm ± 12 mm
- in case of installation on existing G 1/2" connections, adaptor no. 02026000 must be used
- operating pressure min. 2 bar / max. 10 bar
- MWELS 1 tick



✓ Good
Water Consumption: 8.50 litres/min
Type of Product: Shower Taps and Mixers
Brand: Hansgrohe
Model: 27127
Reg no.: SHT-2014/015898

Showerpipe

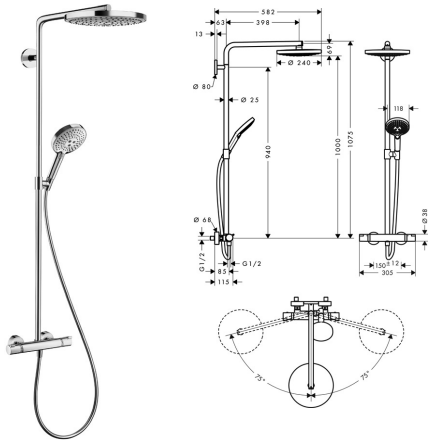

Code No. 27129000

Colour chrome

Raindance Select S 240 2jet Showerpipe

- overhead shower Raindance Select S 240 2jet
- shower head size: 240 mm
- spray type: RainAir, Rain
- convenient diversion via Select button
- spray disc surface in two variants: chrome or white
- shower arm length: 460 mm
- swivel shower arm
- thermostat Ecostat Comfort
- safety lock at 40° C
- adjustable hot water limitation
- outlets controlled via turning handle
- installation type: exposed installation
- connection dimension DN15
- connection thread G 1/2"
- centre distance 150 mm ± 12 mm
- height-adjustable hand shower holder
- MWELS 1 tick



✓ Good

Water Consumption: 7.10 litres/min

Type of Product: Shower Taps and Mixers

Brand: Hansgrohe

Model: Raindance Select E300 Showerpipe 27126

Reg no.: SHT-2014/016121

Showerpanel



Code No. 26870000
Colour chrome

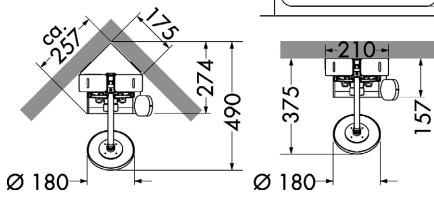
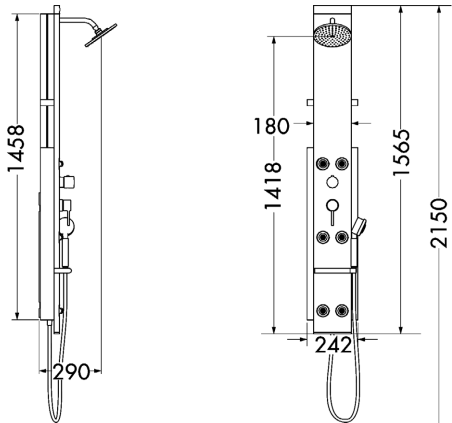

**Showerpanel Lift 2 M 20,
 Wall-/Corner Version, Manual**

- Minimum flow pressure 1,5 bar
- For corner mounting order corner mounting set separately
- Vertical dimensions from shower tray position
- MWELS 2 ticks



✓✓ Very Good
 Water Consumption: 6.60 litres/min
 Type of Product: Shower Taps and Mixers
 Brand: Hansgrohe
 Model: Pharo : 26870 (Lift 2 Panel)
 Reg no.: SHT-2010/005477

Shower

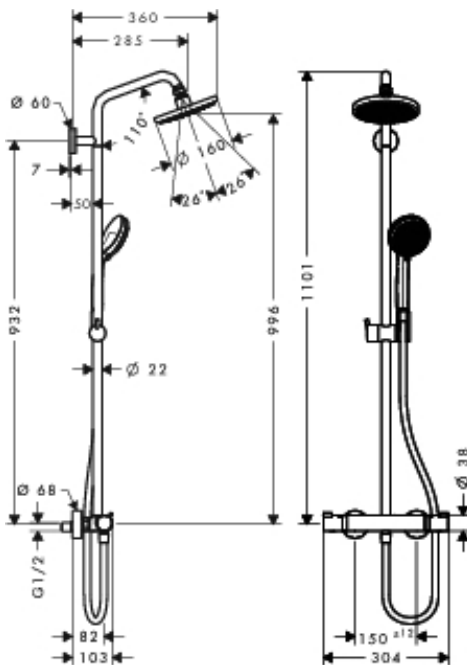
**Croma 160 1jet Showerpipe**

- overhead shower Croma 160
- shower head size: 160 mm
- overhead shower angle adjustable
- spray type: Rain
- shower arm length: 270 mm
- thermostat Ecostat Comfort
- safety lock at 40° C
- adjustable hot water limitation
- outlets controlled via turning handle
- installation type: exposed installation
- connection dimension DN15
- connection thread G 1/2
- centre distance 154 mm ± 12 mm
- height-adjustable hand shower holder
- MWELS 1 tick

Code No. 27135000

Colour chrome



✓ Good

Water Consumption: 7.40 litres/min

Type of Product: Shower Taps and Mixers

Brand: Hansgrohe

Model: Croma 160 Showerpipe 27135

Reg no.: SHT-2014/016132

Shower

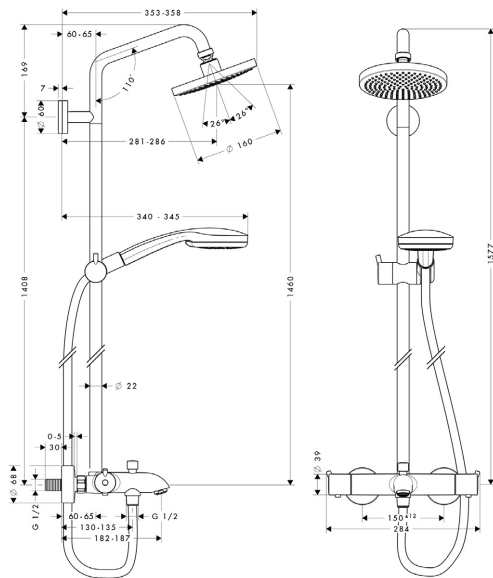

Code No. 27143000

Colour chrome

Croma 100 1jet Showerpipe for bath tub

- overhead shower Croma 160
- shower head size: 160 mm
- overhead shower angle adjustable
- spray type: Rain
- operating pressure: min. 1,5 bar / max. 10 bar
- shower arm length: 270 mm
- thermostat Ecostat S
- safety lock at 40° C
- adjustable hot water limitation
- outlets controlled via turning handle
- installation type: exposed installation
- connection dimension DN15
- connection thread G 1/2
- centre distance 150 mm ± 12 mm
- height-adjustable hand shower holder
- scope of supply: wall bar spacer (grey)
- MWELS 1 tick



✓ Good

Water Consumption: 7.30 litres/min

Type of Product: Shower Taps and Mixers

Brand: Hansgrohe

Model: 27143

Registration No.: SHT-2015/017304

Shower

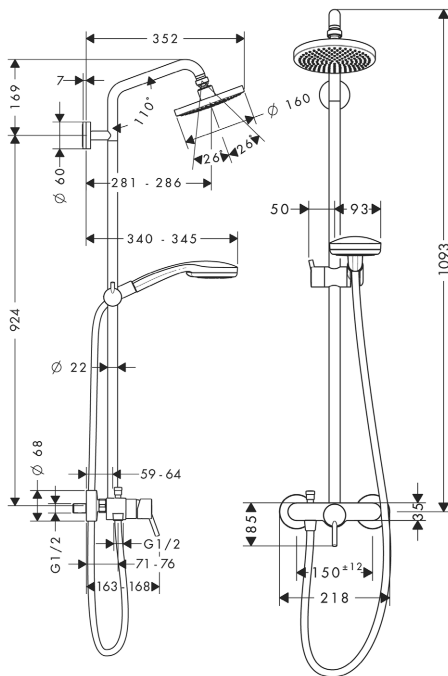

Croma 100 Showerpipe Single Lever Mixer, DN15

consisting of

- ceramic cartridge, adjustable temperature restriction
- suitable for continuous flow water heaters, if the flow pressure at the mixer is a minimum of 0.15MPa / 12 l/min
- centre distance 150mm ± 12mm
- Boltic lever lock
- diverter for hand shower
- Croma Ø 160mm overhead shower with QuickClean anti-lime scale system (no.27450000)
- Croma 100 Vario hand shower (no.28535000)
- Isiflex shower hose 1.60m DN15 (no.28276000)
- height-adjustable shower holder
- wall bar spacer 7mm (no.95239000)
- MWELS 1 tick

Code No. 27154000

Colour chrome



✓ Good

Water Consumption: 8.90 litres/min

Type of Product: Shower Taps and Mixers

Brand: Hansgrohe

Model: Croma 100 Showerpipe with Single Lever Mixer 27154

Reg no.: SHT-2013/012580

Shower

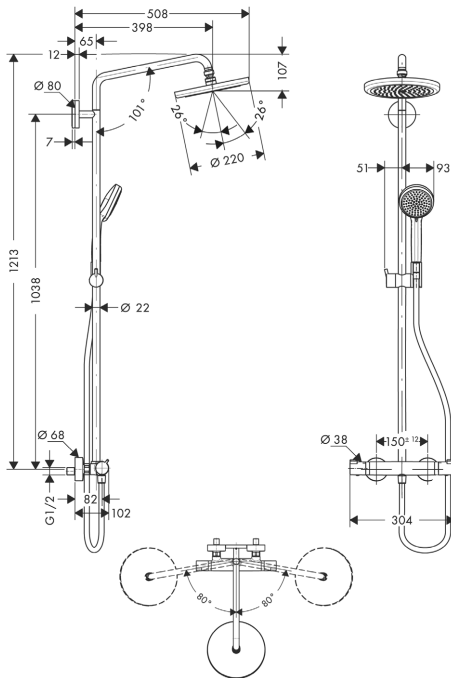
**Croma 220 Showerpipe, DN15**

consisting of

- overhead shower Croma Ø 220mm with AirPower technology and QuickClean (no.26464000)
- shower arm 400mm swivelling
- hand shower Croma 100 Vario (no.28535000)
- height adjustable shower holder
- Isiflex shower hose 1.60m DN15 (no.28276000)
- thermostat with safety stop at 40°C
 - pre-adjustable hot water restriction
 - shut-off/ diverter valve for overhead/ hand shower
 - centre distance 150mm ± 12mm
 - S-shaped connections with noise reduction
- with wall bar spacer 8mm (no.98681000)
- MWELS 1 tick

Code No. 27185000

Colour chrome



✓ Good

Water Consumption: 8.00 litres/min

Type of Product: Shower Taps and Mixers

Brand: Hansgrohe

Model: Croma 220 Showerpipe thermostatic Mixer 27185

Reg no.: SHT-2013/012184

Shower

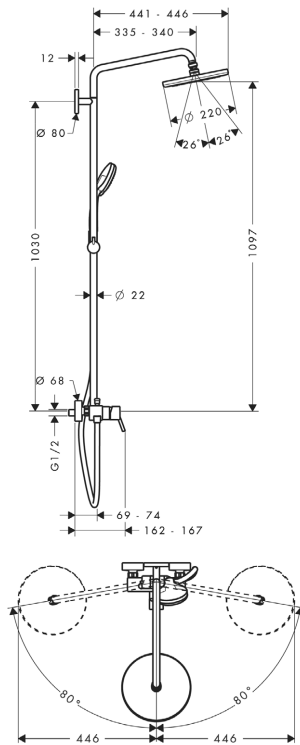

Croma 220 Showerpipe with Single Lever Mixer, DN15

consisting of

- overhead shower Croma Ø 220mm with AirPower technology and QuickClean (no.26464000)
- shower arm 400mm swivelling
- hand shower Croma 100 Vario (no.28535000)
- height adjustable shower holder
- Isiflex shower hose 1.60m DN15 (no.28276000)
- ceramic cartridge
- pre-adjustable hot water restriction
- diverter for overhead shower
- centre distance 150mm ± 12mm
- S-shaped connections with noise reduction
- with wall bar spacer 8mm (no.98681000)
- MWELS 1 tick

Code No. 27222000

Colour chrome



✓ Good

Water Consumption: 8.50 litres/min

Type of Product: Shower Taps and Mixers

Brand: Hansgrohe

Model: Croma 220 Showerpipe with Single Lever Mixer 27222

Reg no.: SHT-2013/012183

Bath

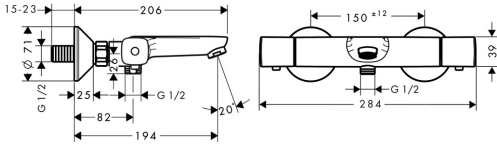

Ecostat Universal Thermostatic Bath Mixer for exposed installation

- projection 200 mm
- 2 outlets
- shut-off/ diverter valve, thermostat cartridge
- safety lock at 40 °C
- temperature limitation adjustable
- non-return valve
- with silencer
- dirt filter included
- centre distance: 150 mm ± 12 mm
- connection dimension: DN15
- connection type: s-shaped connections
- MWELS 1 tick & 2 ticks

Code No. 13123000
13123000E
Colour chrome
white/chrome



✓ **Good**
Water Consumption: 7.60 litres/min
Type of Product: Shower Taps and Mixers
Brand: Hansgrohe
Model: 13123
Registration No.: SHT-2015/017303



✓✓ **Very Good**
Water Consumption: 6.40 litres/min
Type of Product: Shower Taps and Mixers
Brand: Hansgrohe
Model: 13123E
Registration No.: SHT-2015/017306

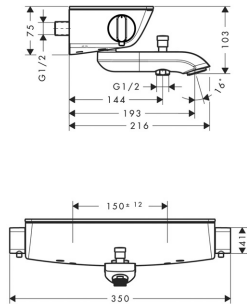

Ecostat Select Thermostatic Bath Mixer for exposed installation

- 2 outlets
- thermostat cartridge, shut-off/ diverter valve
- safety lock at 40 °C
- temperature limitation adjustable
- shelf made of safety glass
- with isolated water conduction
- non-return valve
- with silencer
- dirt filter included
- material: brass
- centre distance 150mm ± 12mm
- connection dimension: DN15
- in case of installation on existing G 1/2 connections, adapter no. 02026000 must be used
- MWELS 1 tick & 2 ticks

Code No. 13141000
13141400
13141000E
13141400E

Colour chrome
white/chrome



✓ **Good**
Water Consumption: 7.30 litres/min
Type of Product: Shower Taps and Mixers
Brand: Hansgrohe
Model: Select 13141
Reg no.: SHT-2013/013704



✓✓ **Very Good**
Water Consumption: 6.30 litres/min
Type of Product: Shower Taps and Mixers
Brand: Hansgrohe
Model: Select 13141E
Reg no.: SHT-2013/013705

Bath

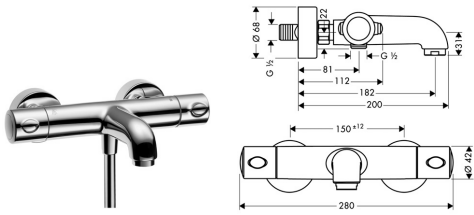

Ecostat 1001 SL Thermostatic Bath Mixer for exposed fitting, DN15

- safety lock at 38°C
- MTC cartridge, non-return valve
- pre-adjustable hot water restriction
- shut-off/diverter valve for bath/shower
- centre distance 150mm ± 12mm
- S-shaped connections with noise reduction
- MWELS 1 tick

Code No. 13241000
13241800
Colour chrome
stainless steel-optic

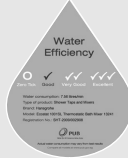

✓ Good
Water Consumption: 7.56 litres/min
Type of Product: Shower Taps and Mixers
Brand: Hansgrohe
Model: Ecostat 1001SL Thermostatic Bath Mixer 13241
Reg no.: SHT-2009/002908

Shower

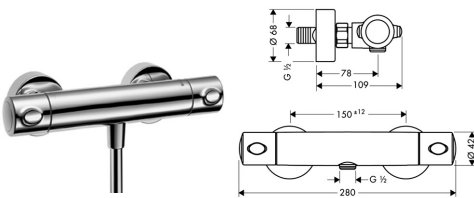

Ecostat 1001 SL Thermostatic Shower Mixer for exposed fitting, DN15

- Ecostop button (limits flow to 10 l/min.), safety stop at 38°C
- MTC cartridge, non-return valve
- pre-adjustable hot water restriction
- centre distance 150mm ± 12mm
- S-shaped connections with noise reduction
- MWELS 1 tick & 2 ticks

Code No. 13261000
13261000E
Colour chrome



✓ Good
Water Consumption: 7.20 litres/min
Type of Product: Shower Taps and Mixers
Brand: Hansgrohe
Model: Ecostat 1001SL Thermo Shower Mixer 13261
Reg no.: SHT-2010/005621



✓✓ Very Good
Water Consumption: 6.40 litres/min
Type of Product: Shower Taps and Mixers
Brand: Hansgrohe
Model: Ecostat 1001SL Thermo Shower Mixer 13261E
Reg no.: SHT-2010/005622

Bath

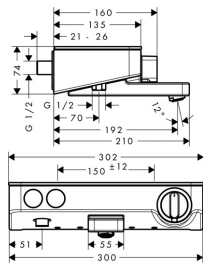

ShowerTablet Select 300 thermostatic bath mixer for exposed installation

- 2 outlets
- simultaneous utilization by 2 consumers
- start/stop cartridge, thermostat cartridge
- safety lock at 40°C
- temperature limitation adjustable
- flow rate hand shower connection at 3 bar: 30 l/min
- flow rate bath filler (at 3 bar): 20 l/min
- shelf made of safety glass
- shelf finish: chrome or white
- with isolated water conduction
- non-return valve
- with silencer
- dirt filter included
- centre distance 150± 12mm
- connection dimension: DN15
- in case of installation on existing G^{1/2} connections, adapter no. 02026000 must be used
- MWELS 1 tick, 2 ticks & 3 ticks

Code No. 13151000
13151000E
13151000L
13151400
13151400E
13151400L

Colour chrome
white chrome



✓ Good
Water Consumption: 7.30 litres/min
Type of Product: Shower Taps and Mixers
Brand: Hansgrohe
Model: 13151
Reg no.: SHT-2014/014283



✓✓ Very Good
Water Consumption: 6.70 litres/min
Type of Product: Shower Taps and Mixers
Brand: Hansgrohe
Model: 13151E
Reg no.: SHT-2014/014284



✓✓✓ Excellent
Water Consumption: 4.70 litres/min
Type of Product: Shower Taps and Mixers
Brand: Hansgrohe
Model: 13151L
Reg no.: SHT-2014/015909

Shower

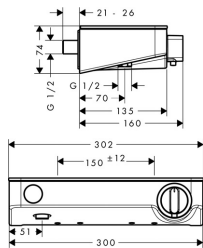

ShowerTablet Select 300 thermostatic shower mixer for exposed installation

- 1 outlet
- start/stop cartridge, thermostat cartridge
- safety lock at 40°C
- temperature limitation adjustable
- flow rate hand shower connection at 3 bar: 30 l/min
- shelf made of safety glass
- shelf finish: chrome or white
- with isolated water conduction
- non-return valve
- with silencer
- dirt filter included
- centre distance 150± 12mm
- connection dimension: DN15
- in case of installation on existing G^{1/2} connections, adapter no. 02026000 must be used
- MWELS 1 tick & 2 ticks

Code No. 13171000
13171000E
13171400
13171400E

Colour chrome
white chrome



✓ Good
Water Consumption: 7.20 litres/min
Type of Product: Shower Taps and Mixers
Brand: Hansgrohe
Model: 13171
Reg no.: SHT-2014/014281



✓✓ Very Good
Water Consumption: 6.60 litres/min
Type of Product: Shower Taps and Mixers
Brand: Hansgrohe
Model: 13171E
Reg no.: SHT-2014/014282

Basin

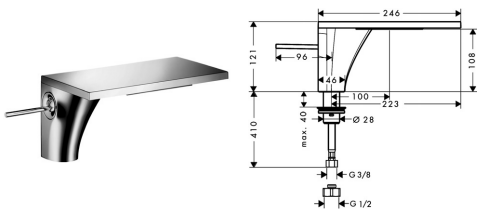

Single Lever Basin Mixer DN15

- wide flood jet
- joystick cartridge
- flush grated waste
- suitable for continuous flow water heaters
- MWELS 1 tick & 2 ticks

Code No. 18010000
 18010000E
Colour chrome



✓ Good
 Water Consumption: 4.20 litres/min
 Type of Product: Basin Taps and Mixers
 Brand: Axor
 Model: Massaud 18010
 Reg no.: BST-2010/004931



✓✓ Very Good
 Water Consumption: 3.10 litres/min
 Type of Product: Basin Taps and Mixers
 Brand: Axor
 Model: 18010E
 Reg no.: BST-2014/014479

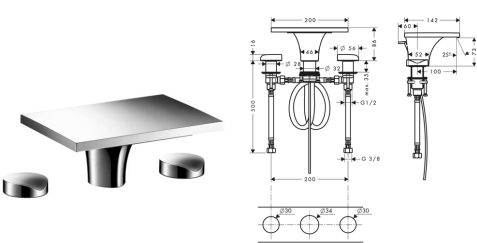

3-hole Basin Mixer with pop-up waste set

- ComfortZone 90
- projection 100 mm
- wide flood jet
- ceramic valves hot/ cold 90°
- temperature limitation not adjustable
- pop-up waste set G 1/4
- suitable for continuous flow water heaters
- connection dimension: DN15
- MWELS 2 ticks & 3 ticks

Code No. 18013000E
 18013000L
Colour chrome



✓✓ Very Good
 Water Consumption: 3.30 litres/min
 Type of Product: Basin Taps and Mixers
 Brand: Axor
 Model: 18013E
 Reg no.: BST-2014/015812



✓✓✓ Excellent
 Water Consumption: 1.70 litres/min
 Type of Product: Basin Taps and Mixers
 Brand: Axor
 Model: 18013L
 Reg no.: BST-2014/015813

Basin

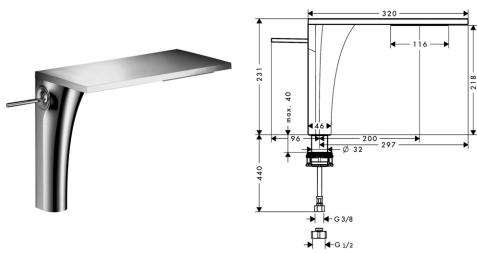

Single Lever Basin Mixer for wash bowls DN15

- wide flood jet
- joystick cartridge
- flush grated waste
- suitable for continuous flow water heaters
- MWELS 1 tick

Code No. 18020000

Colour chrome



✓ Good

Water Consumption: 4.24 litres/min

Type of Product: Basin Taps and Mixers

Brand: Axor

Model: Massaud Highriser single lever 18020

Reg no.: BST-2009/001683

Bath

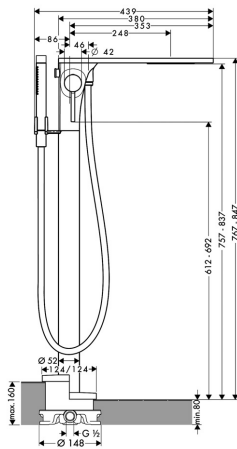

Free-standing Single Lever Bath Mixer DN15

- for mounting onto bathroom floor
- ceramic cartridge
- button with stop/diverter valve to revert from shower to bath filler
- with Axor Starck hand shower with Normal and Soft spray, shower hose 1.25m, diverter for use with:
 - basic set no.10452180
 - extension for standing pipe no.97686000
 - MWELS 1 tick

Code No. 18450000

Colour chrome



✓ Good

Water Consumption: 7.40 litres/min

Type of Product: Shower Taps and Mixers

Brand: Axor

Model: Massaud Free Standing Bath Mixer 18450

Reg no.: SHT-2009/003277

Basin

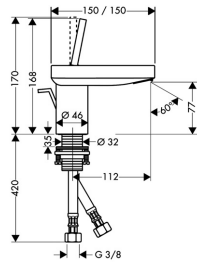

Single Lever Basin Mixer 100mm DN15

- adjustable flood jet
- joystick cartridge
- pop-up waste set 1 1/4"
- suitable for continuous flow water heaters
- MWELS 1 tick & 2 ticks

Code No. 10070000
 10070000E
Colour chrome



✓ **Good**
 Water Consumption: 5.10 litres/min
 Type of Product: Basin Taps and Mixers
 Brand: Axor
 Model: Starck 'X'
 Reg no.: BST-2009/001684



✓✓ **Very Good**
 Water Consumption: 3.10 litres/min
 Type of Product: Basin Taps and Mixers
 Brand: Axor
 Model: 10070E
 Reg no.: BST-2015/017708

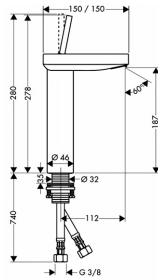

Single Lever Basin Mixer 210mm without waste set DN15

- height of spout 187mm
- adjustable flood jet
- joystick cartridge
- suitable for continuous flow water heaters
- MWELS 1 tick

Code No. 10071000
Colour chrome



✓ **Good**
 Water Consumption: 4.10 litres/min
 Type of Product: Basin Taps and Mixers
 Brand: Axor
 Model: Starck 'X'
 Reg no.: BST-2009/001299

Basin

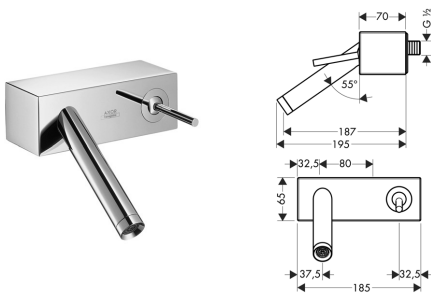

Single Lever Basin Mixer wall-mounted with spout 187 mm

- projection 187 mm
- centre distance: 80 mm ± 16 mm
- joystick ceramic cartridge
- temperature limitation not adjustable
- non-closing flush grated valve
- suitable for continuous flow water heaters
- connection dimension: DN15
- MWELS 1 tick & 2 ticks

Code No. 10074000
 10074000E
Colour chrome



✓ Good
 Water Consumption: 5.20 litres/min
 Type of Product: Basin Taps and Mixers
 Brand: Axor
 Model: 10074
 Registration No.: BST-2015/016957



✓✓ Very Good
 Water Consumption: 3.50 litres/min
 Type of Product: Basin Taps and Mixers
 Brand: Axor
 Model: 10074E
 Registration No.: BST-2015/016955

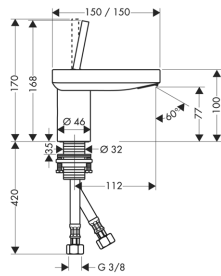

Single lever basin mixer 100 without pull-rod

- ComfortZone 80
- projection 112 mm
- wide flood jet
- adjustable spray former
- joystick ceramic cartridge
- temperature limitation not adjustable
- pop-up waste set G 1 1/4"
- suitable for continuous flow water heaters
- connection dimension: DN15
- MWELS 2 ticks

Code No. 10077000E
Colour chrome



✓✓ Very Good
 Water Consumption: 3.00 litres/min
 Type of Product: Basin Taps and Mixers
 Brand: Axor
 Model: 10077E
 Registration No.: BST-2015/017709

Basin

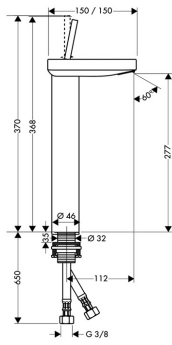

Single Lever Basin Mixer for wash basins 300mm without waste set DN15

- height of spout 277mm
- adjustable flood jet
- joystick cartridge
- suitable for continuous flow water heaters
- MWELS 1 tick

Code No. 10080000

Colour chrome



✓ Good
 Water Consumption: 4.50 litres/min
 Type of Product: Basin Taps and Mixers
 Brand: Axor
 Model: Starck X Single Lever Basin Mixer 300mm 10080
 Reg no.: BST-2009/003764

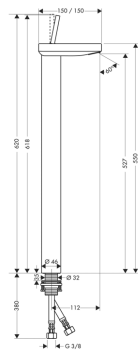
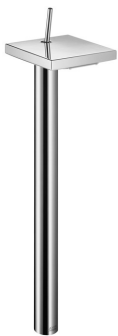

Single Lever Basin Mixer 550 without pull-rod for washbowls

- ComfortZone 530
- projection 112 mm
- wide flood jet
- adjustable spray former
- joystick ceramic cartridge
- temperature limitation not adjustable
- non-closing flush grated valve
- suitable for continuous flow water heaters
- connection dimension: DN15
- MWELS 1 tick

Code No. 10084000

Colour chrome



✓ Good
 Water Consumption: 4.90 litres/min
 Type of Product: Basin Taps and Mixers
 Brand: Axor
 Model: 10084
 Reg no.: BST-2014/015903

Bath

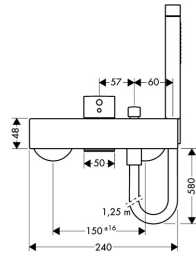

Single Lever Bath Mixer for exposed fitting DN15

- swivel flood jet, ceramic cartridge
- button with stop/diverter valve to revert from shower to bath filler
- hose connection DN15, centre distance 150 ± 12mm, with Axor Starck hand shower
- shower hose 1.25m, non-return valve
- suitable for continuous flow water heaters
- MWELS 1 tick

Code No. 10402000

Colour chrome



✓ Good

Water Consumption: 7.40 litres/min

Type of Product: Shower Taps and Mixers

Brand: Axor

Model: Starck X Single lever Exposed Bath Mixer 10402

Reg no.: SHT-2009/003757

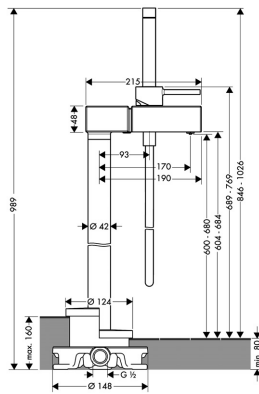

Free-standing Single Lever Bath Mixer DN15

- swivel flood jet, ceramic cartridge
 - button with stop/diverter valve to revert from shower to bath filler
 - hose connection DN15
 - with Axor Starck hand shower with Normal and Soft spray
 - shower hose 1.25m
 - non-return valve
 - MWELS 1 tick
- for use with:
- basic set no.10452180
 - extension no.97686000
 - seal no.96441000

Please note: Suitable only for bath tubs with a maximum rim width of 65mm.

Code No. 10406000

Colour chrome



✓ Good

Water Consumption: 7.50 litres/min

Type of Product: Shower Taps and Mixers

Brand: Axor

Model: Starck X Free Standing Bath Mixer 10406

Reg no.: SHT-2010/004540

Basin

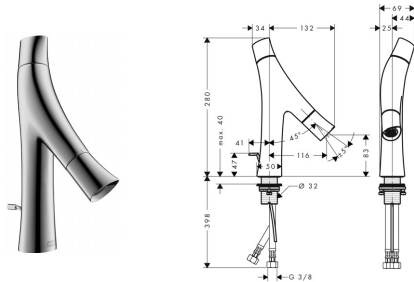

2-Handle Basin Mixer 280, DN15

- shower spray with QuickClean
- separate temperature and flow controls with swivel action
- pop-up waste set G 1 1/4"
- adjustable temperature restriction
- water channels separated from brass body
- suitable for continuous flow water heaters
- MWELS 1 tick

Code No. 12010000

Colour chrome



✓ Good

Water Consumption: 4.70 litres/min

Type of Product: Basin Taps and Mixers

Brand: Axor

Model: Starck Organic 12010000 (Booster Mode)

Reg no.: BST-2013/012403

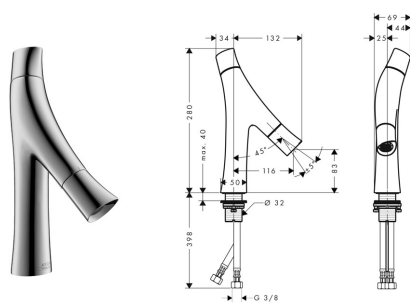

2-Handle Basin Mixer 280, without pull rod DN15

- shower spray with QuickClean
- separate temperature and flow controls with swivel action
- non-closing flush grated valve
- adjustable temperature restriction
- water channels separated from brass body
- suitable for continuous flow water heaters
- MWELS 1 tick

Code No. 12011000

Colour chrome



✓ Good

Water Consumption: 4.70 litres/min

Type of Product: Basin Taps and Mixers

Brand: Axor

Model: Starck Organic 12011

Reg no.: BST-2013/012402

Basin

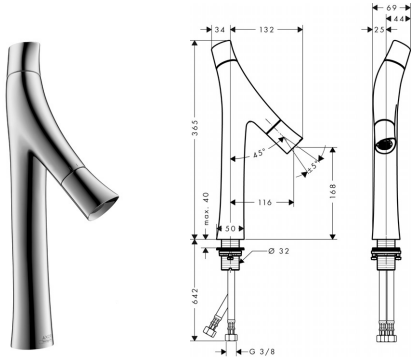

**2-Handle Basin Mixer 365,
 without pull rod,
 for Wash Bowls, DN15**

- shower spray with QuickClean
- separate temperature and flow controls with swivel action
- non-closing flush grated valve
- adjustable temperature restriction
- water channels separated from brass body
- suitable for continuous flow water heaters
- MWELS 1 tick & 2 ticks

Code No. 12012000
 12012000E
Colour chrome



✓ Good
 Water Consumption: 5.10 litres/min
 Type of Product: Basin Taps and Mixers
 Brand: Axor
 Model: Starck Organic 12012
 Reg no.: BST-2013/013717



✓✓ Very Good
 Water Consumption: 2.90 litres/min
 Type of Product: Basin Taps and Mixers
 Brand: Axor
 Model: Starck Organic 12012E
 Reg no.: BST-2013/013718

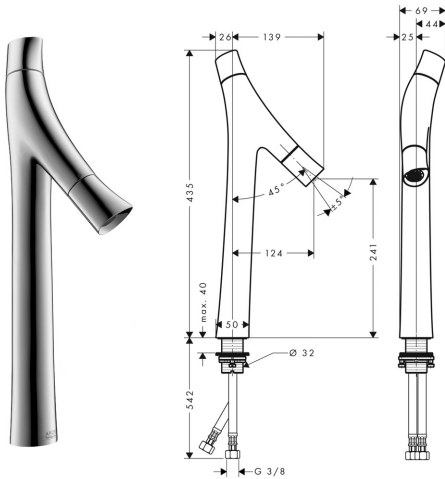

**2-Handle Basin Mixer 435,
 without pull rod,
 for Wash Bowls, DN15**

- shower spray with QuickClean
- separate temperature and flow controls with swivel action
- non-closing flush grated valve
- adjustable temperature restriction
- water channels separated from brass body
- suitable for continuous flow water heaters
- MWELS 1 tick

Code No. 12013000
Colour chrome



✓ Good
 Water Consumption: 4.80 litres/min
 Type of Product: Basin Taps and Mixers
 Brand: Axor
 Model: Starck Organic 12013
 Reg no.: BST-2013/012400

Basin

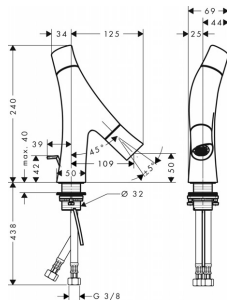
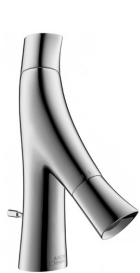

**2-Handle Basin Mixer 240,
for Hand Basins, DN15**

- shower spray with QuickClean
- separate temperature and flow controls with swivel action
- pop-up waste set G 1 1/4"
- adjustable temperature restriction
- water channels separated from brass body
- suitable for continuous flow water heaters
- MWELS 1 tick

Code No. 12014000

Colour chrome



✓ Good

Water Consumption: 4.70 litres/min
Type of Product: Basin Taps and Mixers
Brand: Axor
Model: Starck Organic 12014
Reg no.: BST-2013/012399

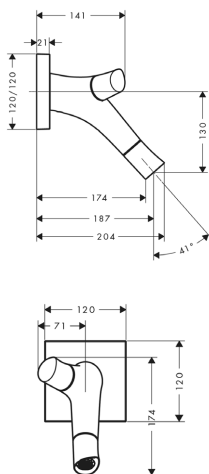

**2-Handle Basin Mixer,
wall-mounting, DN15**

- shower spray with QuickClean
- separate temperature and flow controls with swivel action
- non-closing flush grated valve
- adjustable temperature restriction
- water channels separated from brass body
- suitable for continuous flow water heaters
- MWELS 1 tick

for use with:

- Basic Set no.10902180, Extension Set no.12918000, Seal no.96660000

Code No. 12015000

Colour chrome



✓ Good

Water Consumption: 4.70 litres/min
Type of Product: Basin Taps and Mixers
Brand: Axor
Model: Starck Organic 12015 + 10902180
Reg no.: BST-2013/012401

Basin

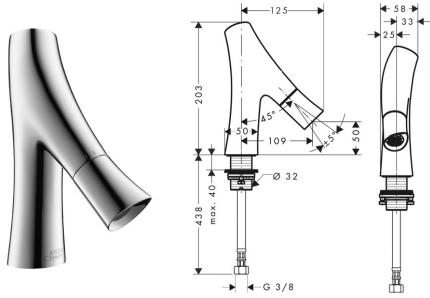

Pillar tap without waste set

- ComfortZone 50
- shower spray
- adjustable spray former
- ceramic valve for volume control
- with isolated water conduction
- without waste set
- suitable for continuous flow water heaters
- connection dimension: DN15
- MWELS 1 tick

Code No. 12110000

Colour chrome



✓ Good

Water Consumption: 4.80 litres/min

Type of Product: Basin Taps and Mixers

Brand: Axor

Model: STARCK ORGANIC PILLAR TAP 12110 MONO

Reg no.: BST-2013/012397



✓ Good

Water Consumption: 5.00 litres/min

Type of Product: Basin Taps and Mixers

Brand: Axor

Model: STARCK ORGANIC PILLAR TAP 12110 SPRAY MODE

Reg no.: BST-2013/012398

Bath

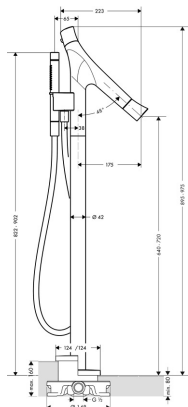
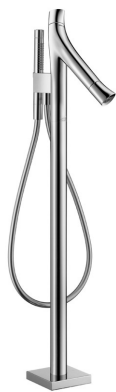

Thermostatic bath mixer floor-standing

- projection 175 mm
- 2 outlets
- thermostat cartridge, shut-off/ diverter valve
- safety lock at 40° C
- temperature limitation adjustable
- spray type: laminar spray
- integrated shower support
- non-return valve
- dirt filter included
- connection dimension: DN15
- connection type: basic set
- MWELS 1 tick & 2 ticks

Code No. 12016000
 12016000E
Colour chrome



✓ Good
 Water Consumption: 7.50 litres/min
 Type of Product: Shower Taps and Mixers
 Brand: Axor
 Model: Starck Organic 12016
 Reg no.: SHT-2014/016388



✓✓ Very Good
 Water Consumption: 6.30 litres/min
 Type of Product: Shower Taps and Mixers
 Brand: Axor
 Model: Starck Organic 12016E
 Reg no.: SHT-2014/016389

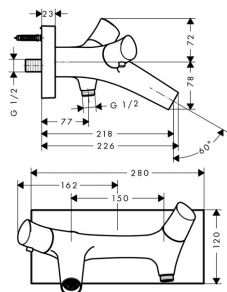

Thermostatic Bath Mixer for exposed installation

- 2 outlets
- thermostat cartridge, shut-off/ diverter valve
- safety stop at 40° C
- temperature limitation adjustable
- spray type: normal spray
- non-return valve
- with silencer
- material: brass
- centre distance 150 ± 12mm
- scope of supply: metal secutcheon
- connection dimension: DN15
- MWELS 1 tick & 2 ticks

Code No. 12410000
 12410000E
Colour chrome



✓ Good
 Water Consumption: 7.10 litres/min
 Type of Product: Shower Taps and Mixers
 Brand: Axor
 Model: Organic Exposed Thermostatic Bath Mixer 12410
 Reg no.: SHT-2013/013027



✓✓ Very Good
 Water Consumption: 6.50 litres/min
 Type of Product: Shower Taps and Mixers
 Brand: Axor
 Model: Organic Exposed Thermostatic Bath Mixer 12410E
 Reg no.: SHT-2013/013028

Shower

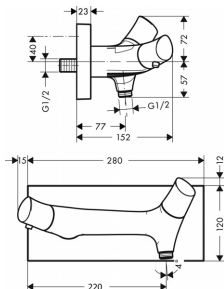

Thermostatic Shower Mixer for exposed installation

- 1 outlet
- thermostat cartridge
- safety lock at 40 °C
- temperature limitation adjustable
- scope of supply: metal escutcheon
- non-return valve, with silencer
- material: brass
- centre distance 150 ± 12mm
- connection dimension: DN15
- MWELS 1 tick

Code No. 12602000
 12602000E
Colour chrome



✓ Good
 Water Consumption: 7.60 litres/min
 Type of Product: Shower Taps and Mixers
 Brand: Axor
 Model: Organic Exposed Thermostatic Shower Mixer 12602
 Reg no.: SHT-2013/013025



✓✓ Very Good
 Water Consumption: 6.40 litres/min
 Type of Product: Shower Taps and Mixers
 Brand: Axor
 Model: Organic Exposed Thermostatic Shower Mixer 12602E
 Reg no.: SHT-2013/013026

Basin

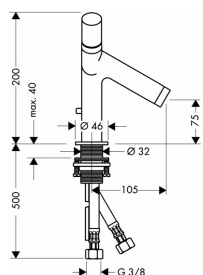

2-Handle Basin Mixer DN15

- ceramic valves hot/cold 180°
- QuickClean aerator
- pop-up waste set G 1 1/4"
- suitable for continuous flow water heaters
- MWELS 1 tick

Code No. 10030000

Colour chrome



✓ Good

Water Consumption: 4.70 litres/min

Type of Product: Basin Taps and Mixers

Brand: Axor

Model: Starck Two Handle Basin Mixer 10030

Reg no.: BST-2010/005556

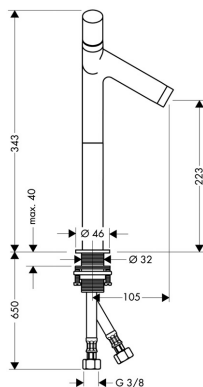

2-Handle Basin Mixer for wash bowls without pull-rod DN15

- ceramic valves hot/cold 180°
- QuickClean aerator
- non-closing flush grated valve
- suitable for continuous flow water heaters
- MWELS 1 tick

Code No. 10058000

Colour chrome



✓ Good

Water Consumption: 4.60 litres/min

Type of Product: Basin Taps and Mixers

Brand: Axor

Model: Starck Two Handle Highriser Basin Mixer 10058

Reg no.: BST-2010/005734

Basin

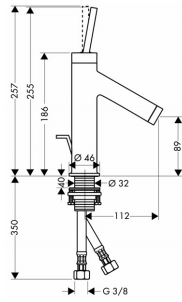

Single Lever Basin Mixer 185 with pop-up waste set

- ComfortZone 90
- normal spray
- joystick ceramic cartridge
- temperature limitation not adjustable
- pop-up waste set G 1 1/4
- suitable for continuous flow water heaters
- connection dimension: DN15
- MWELS 1 tick & 2 ticks

Code No. 10111000
 10111000E
Colour chrome



✓ Good
 Water Consumption: 5.20 litres/min
 Type of Product: Basin Taps and Mixers
 Brand: Axor
 Model: Starck Basin Mixer 185 10111
 Reg no.: BST-2013/013256



✓✓ Very Good
 Water Consumption: 3.10 litres/min
 Type of Product: Basin Taps and Mixers
 Brand: Axor
 Model: Starck Basin Mixer 185 10111E
 Reg no.: BST-2013/013257

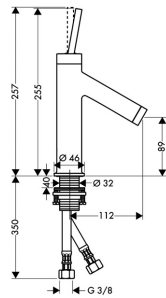

Single Lever Basin Mixer without waste set DN15

- joystick cartridge
- QuickClean aerator
- suitable for continuous flow water heaters
- MWELS 1 tick

Code No. 10117000
Colour chrome



✓ Good
 Water Consumption: 4.50 litres/min
 Type of Product: Basin Taps and Mixers
 Brand: Axor
 Model: Starck Puro Single lever basin mixer w/o waste set
 Reg no.: BST-2009/001686

Basin

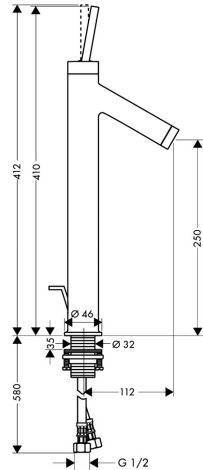

Single Lever Basin Mixer for wash bowls DN15

- joystick cartridge
- QuickClean aerator
- pop-up waste set 1 1/4"
- suitable for continuous flow water heaters
- MWELS 1 tick

Code No. 10120000
Colour chrome



✓ Good
 Water Consumption: 4.30 litres/min
 Type of Product: Basin Taps and Mixers
 Brand: Axor
 Model: Starck Puro highriser single lever basin mixer
 Reg no.: BST-2009/001712

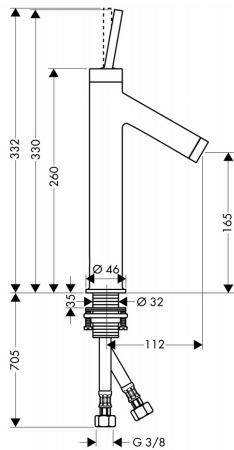

Single Lever Basin Mixer 260 without pull rod

- ComfortZone 170
- normal spray
- joystick ceramic cartridge
- temperature limitation not adjustable
- non-closing flush grated valve
- suitable for continuous flow water heaters
- connection dimension: DN15
- MWELS 1 tick & 2 ticks

Code No. 10123000
 10123000E
Colour chrome



✓ Good
 Water Consumption: 4.60 litres/min
 Type of Product: Basin Taps and Mixers
 Brand: Axor
 Model: Basin Mixer 260
 W/O Rod 10123
 Reg no.: BST-2013/013254



✓✓ Very Good
 Water Consumption: 2.80 litres/min
 Type of Product: Basin Taps and Mixers
 Brand: Axor
 Model: Starck Basin Mixer 260
 W/O Rod 10123E
 Reg no.: BST-2013/013255

Basin

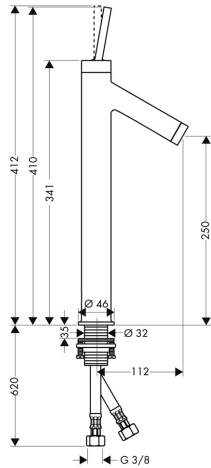

**Single Lever Basin Mixer 340
without pull rod**

- ComfortZone 250
- normal spray
- joystick ceramic cartridge
- temperature limitation not adjustable
- pop-up waste set G 1 1/4
- suitable for continuous flow water heaters
- connection dimension: DN15
- MWELS 1 tick & 2 ticks

Code No. 10129000
10129000E
Colour chrome



✓ Good
Water Consumption: 4.70 litres/min
Type of Product: Basin Taps and Mixers
Brand: Axor
Model: Starck Basin Mixer 340
W/O Rod 10129
Reg no.: BST-2013/013258



✓✓ Very Good
Water Consumption: 3.00 litres/min
Type of Product: Basin Taps and Mixers
Brand: Axor
Model: Starck Basin Mixer 340
W/O Rod 10129E
Reg no.: BST-2013/013259

Bath

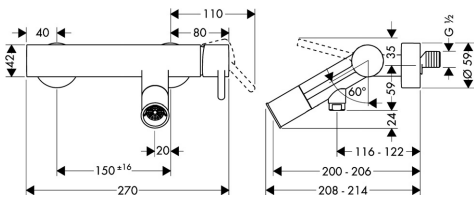

**Single Lever Bath Mixer
for exposed installation**

- scope of supply: metal escutcheon
- s-shaped connections
- centre distance 150 ± 16mm
- projection: 200mm
- normal spray
- ceramic cartridge
- temperature limitation adjustable
- with automatic resetting
- material: solid brass
- non-return valve
- with silencer
- no integrated shower support
- suitable for continuous flow water heaters
- connection dimension: DN15
- MWELS 1 tick

Code No. 10411000
Colour chrome



✓ Good
Water Consumption: 8.00 litres/min
Type of Product: Shower Taps and Mixers
Brand: Axor
Model: Starck Single Lever Exposed Bath Mixer 10411
Reg no.: SHT-2009/003755

Bath

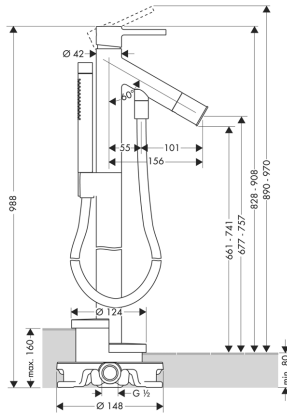

Free-standing Single Lever Bath Mixer DN15

- for mounting on the bathroom floor
- ceramic cartridge
- non-return valve
- button with stop/diverter valve to revert from shower to bath filler
- with Axor Starck hand shower with Normal and Soft spray, shower hose 1.25m, diverter
- MWELS 1 tick & 2 ticks

for use with:

- basic set no. 10452180
- spout extension 60mm no.10981000
- spout extension 20mm no.10983000
- pipe extension 60mm no.97686000
- seal no.96441000

Code No. 10456000
 10456000E
Colour chrome



✓ Good
 Water Consumption: 7.70 litres/min
 Type of Product: Shower Taps and Mixers
 Brand: Axor
 Model: Starck - 10456
 Reg no.: SHT-2009/002149



✓✓ Very Good
 Water Consumption: 6.40 litres/min
 Type of Product: Shower Taps and Mixers
 Brand: Axor
 Model: 10456E
 Reg no.: SHT-2015/017710

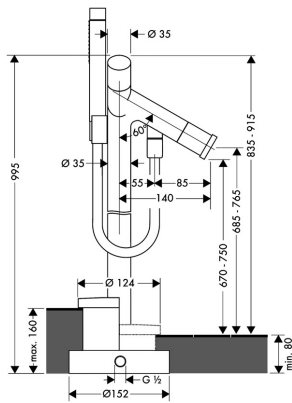

Free-standing 2-Handle Bath Mixer DN15

- for mounting on the bathroom floor
- ceramic valves hot/cold
- non-return valve
- button with stop/diverter valve to revert from shower to bath filler
- with Axor Starck hand shower with Normal and Soft spray, shower hose 1.25m, diverter
- MWELS 1 tick

for use with:

- basic set no.10452180
- spout extension 60mm no.10981000
- spout extension 20mm no.10983000
- pipe extension 60mm no.97686000
- seal no.96441000

Code No. 10458000
Colour chrome



✓ Good
 Water Consumption: 7.90 litres/min
 Type of Product: Shower Taps and Mixers
 Brand: Axor
 Model: Starck 2 Handle Free Standing bath Mixer 10458
 Reg no.: SHT-2010/004527

Basin

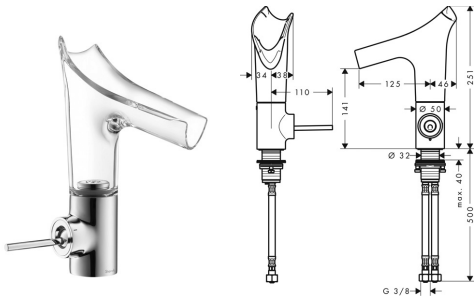

Code No. 12112000E

Colour chrome

Single lever basin mixer 140

- handle can be positioned on the right or left, depends on the basic set installation
- ComfortZone 140
- combination of crystal glass and metal
- projection 125 mm
- laminar spray
- EasyClick connection between body and spout
- spout is dishwasher safe
- removeable spout with SafetyStop-function
- joystick ceramic cartridge
- temperature limitation not adjustable
- non-closing flush grated valve
- swivel range 360°
- connection dimension: DN15
- not recommended for the public and semi-public area
- MWELS 2 ticks



✓✓ Very Good

Water Consumption: 3.40 litres/min
 Type of Product: Basin Taps and Mixers
 Brand: Axor
 Model: Starck V 12112E
 Registration No.: BST-2015/017801

Shower

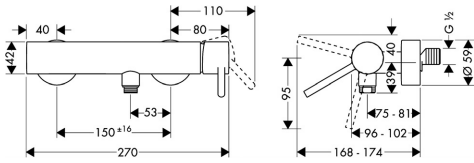

**Single Lever Shower Mixer
 for exposed installation**

- scope of supply: metal escutcheon
- s-shaped connections
- centre distance 150 ± 16mm
- ceramic cartridge
- temperature limitation adjustable
- material: brass
- non-return valve
- with silencer
- suitable for continuous flow water heaters
- hose connection DN15
- connection dimension: DN15
- MWELS 1 tick

Code No. 10611000

Colour chrome



✓ Good
 Water Consumption: 7.50 litres/min
 Type of Product: Shower Taps and Mixers
 Brand: Axor
 Model: Starck Single Lever Exposed Shower Mixer 10611
 Reg no.: SHT-2009/003756

Basin

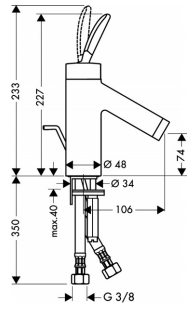

Classic Single Lever Basin Mixer DN15

- joystick cartridge
- QuickClean aerator
- pop-up waste set 1 1/4"
- suitable for continuous flow water heaters
- MWELS 1 tick

Code No. 10010000

Colour chrome



✓ Good
 Water Consumption: 4.30 litres/min
 Type of Product: Basin Taps and Mixers
 Brand: Axor
 Model: Starck Classic Single Lever Basin Mixer 10010
 Reg no.: BST-2010/005038

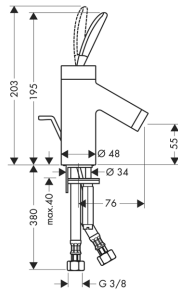

Classic Single Lever Basin Mixer with pop-up waste set for washbasins

- ComfortZone 60
- projection 76 mm
- normal spray
- joystick ceramic cartridge
- temperature limitation not adjustable
- pop-up waste set G 1 1/4"
- suitable for continuous flow water heaters
- connection dimension: DN15
- MWELS 1 tick & 2 ticks

Code No. 10015000

10015000E

Colour chrome



✓ Good
 Water Consumption: 4.80 litres/min
 Type of Product: Basin Taps and Mixers
 Brand: Axor
 Model: 10015
 Reg no.: BST-2014/015906



✓✓ Very Good
 Water Consumption: 2.90 litres/min
 Type of Product: Basin Taps and Mixers
 Brand: Axor
 Model: 10015E
 Reg no.: BST-2014/015907

Basin

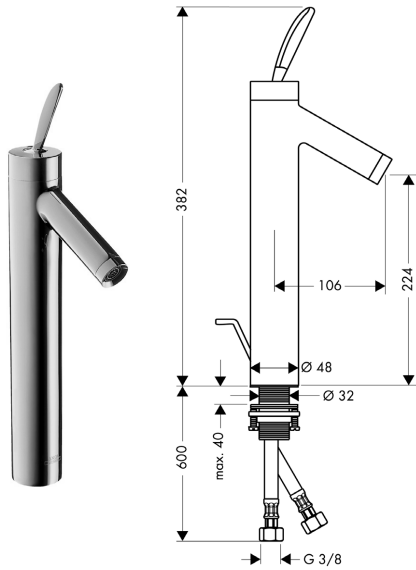

Classic Single Lever Basin Mixer with pop-up waste set for washbowls

- ComfortZone 220
- normal spray
- joystick ceramic cartridge
- temperature limitation not adjustable
- pop-up waste set G 1 1/4"
- suitable for continuous flow water heaters
- connection dimension: DN15
- MWELS 1 tick & 2 ticks

Code No. 10020000
 10020000E
Colour chrome



✓ Good
 Water Consumption: 4.90 litres/min
 Type of Product: Basin Taps and Mixers
 Brand: Axor
 Model: Starck Classic Highriser Basin Mixer 10020
 Reg no.: BST-2013/013260



✓✓ Very Good
 Water Consumption: 2.90 litres/min
 Type of Product: Basin Taps and Mixers
 Brand: Axor
 Model: Starck Classic Highriser Basin Mixer 10020E
 Reg no.: BST-2013/013261

Basin

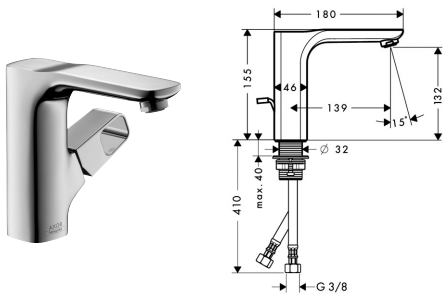

Single Lever Basin Mixer DN15

- ceramic cartridge
- QuickClean anti-limescale system
- pop-up waste set 1 1/4"
- suitable for continuous flow water heaters
- adjustable temperature restriction
- MWELS 1 tick & 2 ticks

Code No. 11020000
 11020000E
Colour chrome



✓ Good
 Water Consumption: 4.40 litres/min
 Type of Product: Basin Taps and Mixers
 Brand: Axor
 Model: Urquiola Single Lever Basin Mixer 11020
 Reg no.: BST-2009/003268



✓✓ Very Good
 Water Consumption: 2.80 litres/min
 Type of Product: Basin Taps and Mixers
 Brand: Axor
 Model: Urquiola Single Lever Basin Mixer 11020E
 Reg no.: BST-2010/006752

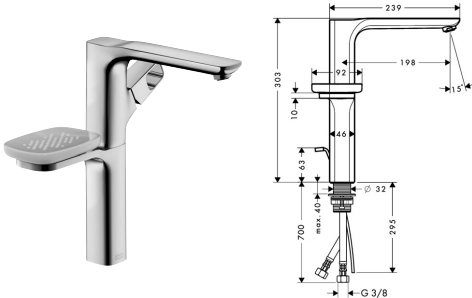

Single Lever Basin Mixer DN15 for wash bowls

- ceramic cartridge
- QuickClean anti-limescale system
- pop-up waste set 1 1/4"
- suitable for continuous flow water heaters
- with toothbrush tumbler and soap dish
- adjustable temperature restriction
- MWELS 1 tick

Code No. 11023000
Colour chrome



✓ Good
 Water Consumption: 4.40 litres/min
 Type of Product: Basin Taps and Mixers
 Brand: Axor
 Model: Urquiola Highriser Basin Mixer 11023
 Reg no.: BST-2009/003267

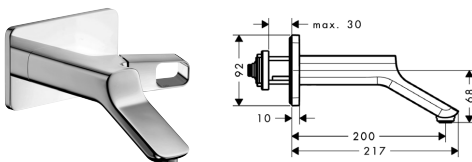

Single Lever Basin Mixer DN15, wall mounting

- ceramic cartridge
- QuickClean anti-limescale system
- non-closing flush grated valve
- suitable for continuous flow water heaters
- adjustable temperature restriction for use with:
- basic set no.10902180
- MWELS 1 tick, 2 ticks & 3 ticks

Code No. 11026000
 11026000E
 11026000L
Colour chrome



✓ Good
 Water Consumption: 4.70 litres/min
 Type of Product: Basin Taps and Mixers
 Brand: Axor
 Model: Urquiola Wall Mounted Basin Mixer 11026
 Reg no.: BST-2009/003181



✓✓ Very Good
 Water Consumption: 2.90 litres/min
 Type of Product: Basin Taps and Mixers
 Brand: Axor
 Model: Urquiola 11026E
 Reg no.: BST-2014/015364



✓✓✓ Excellent
 Water Consumption: 1.70 litres/min
 Type of Product: Basin Taps and Mixers
 Brand: Axor
 Model: Urquiola 110260L
 Reg no.: BST-2014/015470

Basin

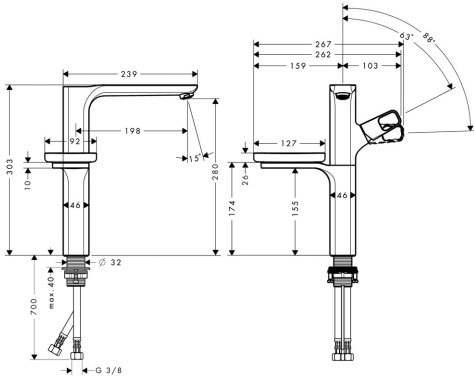

Single Lever Basin Mixer with pop-up waste set and holder for washbowls

- ComfortZone 280
- normal spray
- with toothbrush tumbler and soap dish
- ceramic cartridge
- temperature limitation adjustable
- pop-up waste set G 1 1/4"
- suitable for continuous flow water heaters
- connection dimension: DN15
- MWELS 1 tick, 2 ticks & 3 ticks

Code No. 11034000
 11034000E
 11034000L
Colour chrome



✓ Good
 Water Consumption: 5.10 litres/min
 Type of Product: Basin Taps and Mixers
 Brand: Axor
 Model: Urquiola Basin Mixer
 w/o pull rod - 11034
 Reg no.: BST-2014/014303



✓✓ Very Good
 Water Consumption: 3.00 litres/min
 Type of Product: Basin Taps and Mixers
 Brand: Axor
 Model: Urquiola Basin Mixer
 w/o pull rod - 11034E
 Reg no.: BST-2014/014323



✓✓✓ Excellent
 Water Consumption: 1.60 litres/min
 Type of Product: Basin Taps and Mixers
 Brand: Axor
 Model: Urquiola Basin Mixer
 w/o pull-rod - 11034L
 Reg no.: BST-2014/014374

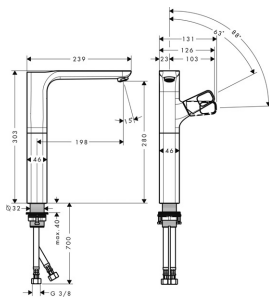

Single Lever Basin Mixer without pull-rod for washbowls

- ComfortZone 280
- normal spray
- ceramic cartridge
- temperature limitation adjustable
- non-closing flush grated valve
- suitable for continuous flow water heaters
- connection dimension: DN15
- MWELS 2 ticks & 3 ticks

Code No. 11035000E
 11035000L
Colour chrome



✓✓ Very Good
 Water Consumption: 3.20 litres/min
 Type of Product: Basin Taps and Mixers
 Brand: Axor
 Model: Urquiola Basin Mixer
 w/o pull-rod - 11035E
 Reg no.: BST-2014/014322



✓✓✓ Excellent
 Water Consumption: 1.60 litres/min
 Type of Product: Basin Taps and Mixers
 Brand: Axor
 Model: Urquiola Basin Mixer
 w/o pull-rod - 11035L
 Reg no.: BST-2014/014375

Basin

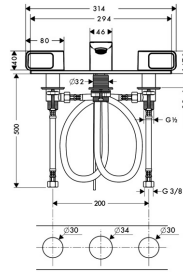

3-Hole Basin Mixer DN15 with plate

- ceramic valves hot/cold 90°
- QuickClean anti-limescale system
- pop-up waste set 1 1/4"
- suitable for continuous flow water heaters
- with connection hoses
- only applicable on even, smooth surfaces.
- MWELS 1 tick

Code No. 11040000

Colour chrome



✓ Good
 Water Consumption: 5.10 litres/min
 Type of Product: Basin Taps and Mixers
 Brand: Axor
 Model: Urquiola Three Hole Basin Mixer Plate 11040
 Reg no.: BST-2009/003436

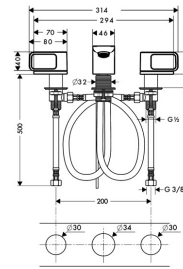

3-Hole Basin Mixer DN15 with escutcheons

- ceramic valves hot/cold 90°
- QuickClean anti-limescale system
- pop-up waste set 1 1/4"
- suitable for continuous flow water heaters
- with connection hoses
- MWELS 1 tick

Code No. 11041000

Colour chrome



✓ Good
 Water Consumption: 5.10 litres/min
 Type of Product: Basin Taps and Mixers
 Brand: Axor
 Model: Urquiola Three Hole Basin Mixer Escutcheon 11041
 Reg no.: BST-2009/003435

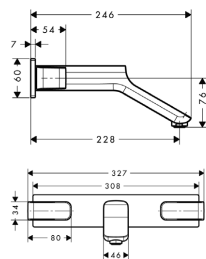

3-Hole Basin Mixer DN15 for concealed installation, with long spout

- finish set for wall mounting
 - ceramic valves hot/cold 90°
 - QuickClean anti-limescale system
 - non-closing flush grated valve
 - suitable for continuous flow water heaters
- for use with:
- basic set no.10303180
 - MWELS 1 tick

Code No. 11043000

Colour chrome



✓ Good
 Water Consumption: 4.70 litres/min
 Type of Product: Basin Taps and Mixers
 Brand: Axor
 Model: Urquiola Three Hole Wall Mounted Basin Mixer 11043
 Reg no.: BST-2009/003434

Bath

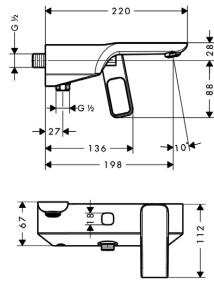

Single Lever Bath Mixer DN15 for exposed installation

- ceramic cartridge
- QuickClean anti-limescale system
- centre distance 150± 16mm
- non-return valve
- autom. reverts from shower to bath filler
- hose connection DN15
- suitable for continuous flow water heaters
- adjustable temperature restriction
- MWELS 1 tick

Code No. 11420000

Colour chrome



✓ Good

Water Consumption: 770 litres/min

Type of Product: Shower Taps and Mixers

Brand: Axor

Model: Urquiola Single Lever Exposed Bath Mixer 11420

Reg no.: SHT-2009/003759

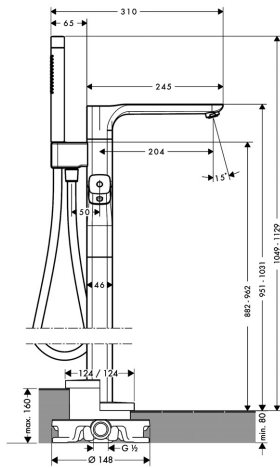

Thermostatic Bath Mixer DN15, floormounted

- for mounting on the bathroom floor
 - thermostat cartridge
 - ceramic shut-off/diverter valve
 - non-return valve
 - QuickClean anti-limescale system
 - with Axor Starck hand shower with Normal and Soft spray, shower hose 1.25m, diverter
 - MWELS 1 tick
- for use with:
- basic set no.10452180
 - seal no.96441000

Code No. 11422000

Colour chrome



✓ Good

Water Consumption: 760 litres/min

Type of Product: Shower Taps and Mixers

Brand: Axor

Model: Urquiola Thermostatic Bath Mixer 11422

Reg no.: SHT-2010/004541

Shower

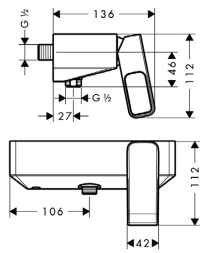

Single Lever Shower Mixer for exposed installation

- s-shaped connections
- centre distance 150± 16mm
- ceramic cartridge
- temperature limitation adjustable
- material: metal
- non-return valve, with silencer
- suitable for continuous flow water heaters
- hose connection DN15
- connection dimension: DN15
- MWELS 1 tick

Code No. 11620000

Colour chrome



✓ Good

Water Consumption: 7.70 litres/min

Type of Product: Shower Taps and Mixers

Brand: Axor

Model: Urquiola Single Lever Exposed Shower Mixer 11620

Reg no.: SHT-2009/003432

Basin

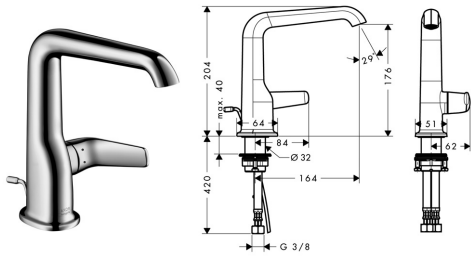

Single Lever Basin Mixer with pop-up waste set

- ComfortZone 180
- laminar spray
- ceramic cartridge
- temperature limitation adjustable
- pop-up waste set G 1 1/4"
- suitable for continuous flow water heaters
- connection dimension: DN15
- MWELS 1 tick

Code No. 19010000

Colour chrome



✓ Good

Water Consumption: 5.30 litres/min

Type of Product: Basin Taps and Mixers

Brand: Axor

Model: Bouroullec Single Lever Basin Mixer 19010

Reg no.: BST-2011/007978

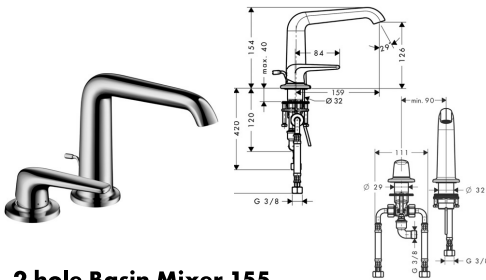

2-hole Basin Mixer 155 with pop-up waste set

- ComfortZone 180
- projection 160mm
- laminar spray
- flexible arrangement of control unit and spout possible
- ceramic cartridge
- temperature limitation adjustable
- pop-up waste set G 1 1/4"
- suitable for continuous flow water heaters
- connection dimension: DN15
- MWELS 1 tick

Code No. 19123000

Colour chrome



✓ Good

Water Consumption: 5.00 litres/min

Type of Product: Basin Taps and Mixers

Brand: Axor

Model: Bouroullec Two Hole Basin Mixer 155mm 19123

Reg no.: BST-2011/007975

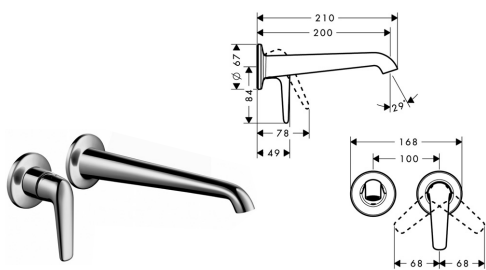

Single Lever Basin Mixer for concealed installation and wall mounting with spout 200mm, DN15

- ceramic cartridge
- non-closing flush grated valve
- suitable for continuous flow water heaters
- adjustable temperature restriction for use with:
- basic set no. 13622180
- MWELS 1 tick

Code No. 19125000

Colour chrome



✓ Good

Water Consumption: 5.10 litres/min

Type of Product: Basin Taps and Mixers

Brand: Axor

Model: Bouroullec Wall Mount Basin Mixer Spout 200mm 19125

Reg no.: BST-2011/008036

Basin

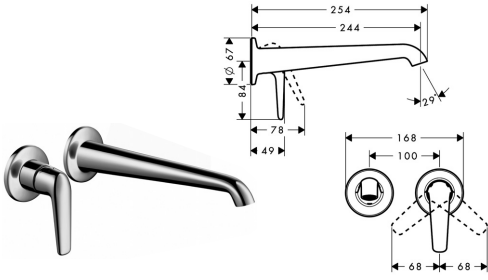

Single Lever Basin Mixer for concealed installation and wall mounting with spout 245mm, DN15

- ceramic cartridge
 - non-closing flush grated valve
 - suitable for continuous flow water heaters
 - adjustable temperature restriction
- for use with: basic set no. 13622180
- possible combinations with Axor Bouroullec basins
 - MWELS 1 tick

Code No. 19127000

Colour chrome



✓ Good

Water Consumption: 5.50 litres/min

Type of Product: Basin Taps and Mixers

Brand: Axor

Model: Bouroullec Wall Mount Basin Mixer Spout 245mm19127

Reg no.: BST-2011/007976



Single Lever Basin Mixer for exposed installation without pull-rod

- body: mineral cast with gelcoat
- laminar spray
- adjustable spray former
- centre distance 150 ± 12mm
- ceramic cartridge
- temperature limitation adjustable
- non-closing flush grated valve
- suitable for continuous flow water heaters
- connection dimension: DN15
- possible combinations with Axor Bouroullec
- MWELS 1 tick

Code No. 19132000

Colour white chrome



✓ Good

Water Consumption: 4.90 litres/min

Type of Product: Basin Taps and Mixers

Brand: Axor

Model: Bouroullec Exposed Single Lever Basin 19132

Reg no.: BST-2011/008031

Basin

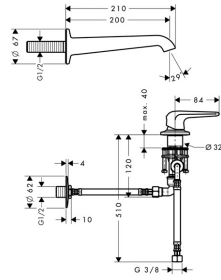

Single Lever Basin Mixer for concealed installation with wall spout 200mm and handle

- projection 200mm
- laminar spray
- flexible arrangement of control unit and spout possible
- ceramic cartridge
- temperature limitation adjustable
- non-closing flush grated valve
- suitable for continuous flow water heaters
- MWELS 1 tick

Code No. 19137000

Colour chrome



✓ Good

Water Consumption: 5.20 litres/min

Type of Product: Basin Taps and Mixers

Brand: Axor

Model: Bouroullec Wall Mount Basin Mixer Spout 200mm 19137

Reg no.: BST-2011/007977

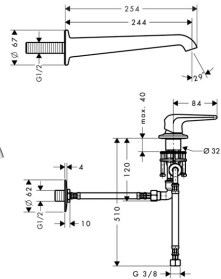

Single Lever Basin Mixer for concealed installation with wall spout 200mm and handle

- projection 200mm
- laminar spray
- flexible arrangement of control unit and spout possible
- ceramic cartridge
- temperature limitation adjustable
- non-closing flush grated valve
- suitable for continuous flow water heaters
- MWELS 1 tick

Code No. 19138000

Colour chrome



✓ Good

Water Consumption: 5.20 litres/min

Type of Product: Basin Taps and Mixers

Brand: Axor

Model: Bouroullec Basin Mixer Wall Spout 245mm 19138

Reg no.: BST-2011/007456

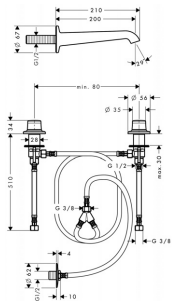

2-Handle Basin Mixer with wall spout 200mm, for concealed installation and valves for mounting on basin/console

- ceramic valves hot/cold 180°
- non-closing flush grated valve
- wall mounting G 1/2
- suitable for continuous flow water heaters
- with connection hoses
- MWELS 1 tick

Code No. 19139000

Colour chrome



✓ Good

Water Consumption: 5.30 litres/min

Type of Product: Basin Taps and Mixers

Brand: Axor

Model: Bouroullec Two Handle Wall Spout 200mm 19139

Reg no.: BST-2011/008152

Basin

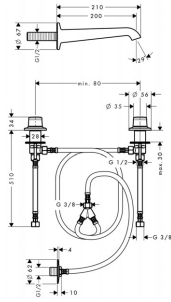

2-Handle Basin Mixer with wall spout 200mm, for concealed installation and valves for mounting on basin/console

- ceramic valves hot/cold 180°
- non-closing flush grated valve
- wall mounting G 1/2
- suitable for continuous flow water heaters
- with connection hoses
- MWELS 1 tick

Code No. 19140000

Colour chrome



✓ Good

Water Consumption: 5.40 litres/min

Type of Product: Basin Taps and Mixers

Brand: Axor

Model: Bouroullec Two Handle Wall Spout 245mm19140

Reg no.: BST-2011/008153

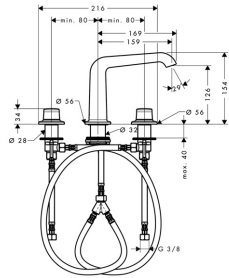

3-Hole Basin Mixer 155, without pull rod, DN15

- ceramic valves hot/cold 180°
- non-closing flush grated valve
- suitable for continuous flow water heaters
- with connections hoses
- Mögliche Kombinationen mit
- possible combinations with Axor Bouroullec
- MWELS 1 tick

Code No. 19141000

Colour chrome



✓ Good

Water Consumption: 5.20 litres/min

Type of Product: Basin Taps and Mixers

Brand: Axor

Model: Bouroullec 3 Hole Basin Mixer 155mm (W/O PR) 19141

Reg no.: BST-2011/007498

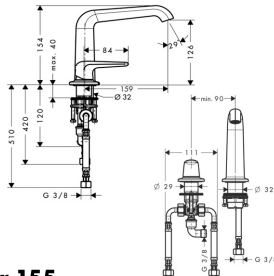

2-hole Basin Mixer 155 with pop-up waste set

- ComfortZone 180
- projection 160mm
- laminar spray
- flexible arrangement of control unit and spout possible
- ceramic cartridge
- temperature limitation adjustable
- pop-up waste set G 1 1/4"
- suitable for continuous flow water heaters
- connection dimension: DN15
- MWELS 1 tick

Code No. 19143000

Colour chrome



✓ Good

Water Consumption: 4.90 litres/min

Type of Product: Basin Taps and Mixers

Brand: Axor

Model: Bouroullec 2 Hole Basin Mixer 155mm (W/O PR) 19143

Reg no.: BST-2011/007457

Basin

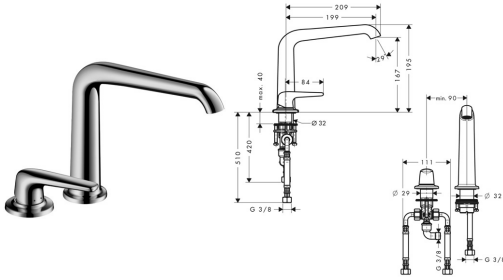

2-Hole Basin Mixer 195 with pop-up waste set

- ComfortZone 170
- projection 200mm, laminar spray
- flexible arrangement of control unit and spout possible
- ceramic cartridge
- temperature limitation adjustable
- pop-up waste set G 1 1/4"
- suitable for continuous flow water heaters
- connection dimension: DN15
- MWELS 1 tick

Code No. 19144000

Colour chrome



✓ Good
 Water Consumption: 5.20 litres/min
 Type of Product: Basin Taps and Mixers
 Brand: Axor
 Model: Bouroullec 2 Hole Basin Mixer 195mm
 Reg no.: BST-2011/007386

Bath

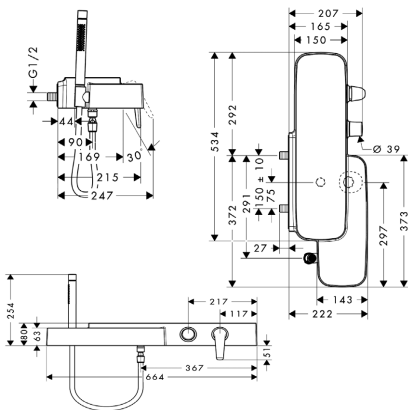

Single Lever Bath Mixer for exposed installation, DN15

- body: mineral cast
- ceramic cartridge
- diverter valve bath/shower
- centre distance 150 ± 12mm
- non-return valve
- with Axor Starck hand shower with normal and soft spray, shower holder, hose connection DN15, shower hose 1,25m
- suitable for continuous flow water heaters
- adjustable temperature restriction
- with non-return valve
- MWELS 1 tick

Code No. 19420400

Colour chrome



✓ Good
 Water Consumption: 7.40 litres/min
 Type of Product: Shower Taps and Mixers
 Brand: Axor
 Model: Bouroullec Exposed Single Lever Bath Mixer 19420
 Reg no.: SHT-2011/008032

Basin

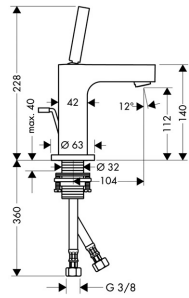

Single Lever Basin Mixer DN15

- joystick cartridge
- QuickClean aerator
- pop-up waste set 1 1/4"
- suitable for continuous flow water heaters
- MWELS 1 tick

Code No. 39010000

Colour chrome



✓ Good
 Water Consumption: 4.40 litres/min
 Type of Product: Basin Taps and Mixers
 Brand: Axor
 Model: Citterio Single lever basin mixer
 Reg no.: BST-2009/001703

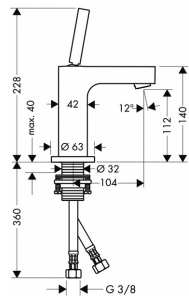

Single Lever Basin Mixer 140 with pop-up waste set

- ComfortZone 110
- normal spray
- joystick ceramic cartridge
- temperature limitation not adjustable
- pop-up waste set G 1 1/4"
- suitable for continuous flow water heaters
- connection dimension: DN15
- MWELS 1 tick, 2 ticks & 3 ticks

Code No. 39018000
 39018000E
 39018000L

Colour chrome



✓ Good
 Water Consumption: 5.10 litres/min
 Type of Product: Basin Taps and Mixers
 Brand: Axor
 Model: Citterio 39018
 Reg no.: BST-2014/014530



✓✓ Very Good
 Water Consumption: 3.10 litres/min
 Type of Product: Basin Taps and Mixers
 Brand: Axor
 Model: Citterio 39018E
 Reg no.: BST-2014/014531



✓✓✓ Excellent
 Water Consumption: 1.70 litres/min
 Type of Product: Basin Taps and Mixers
 Brand: Axor
 Model: Citterio 39018L
 Reg no.: BST-2014/014605

Basin

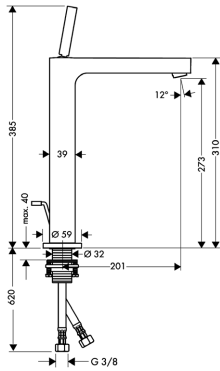

Single Lever Basin Mixer for wash bowls DN15

- joystick cartridge
- QuickClean aerator
- pop-up waste set 1 1/4"
- suitable for continuous flow water heaters
- MWELS 1 tick, 2 ticks & 3 ticks

Code No. 39020000
 39020000E
 39020000L
Colour chrome



✓ Good
 Water Consumption: 4.20 litres/min
 Type of Product: Basin Taps and Mixers
 Brand: Axor
 Model: Citterio
 Reg no.: BST-2009/001300



✓✓ Very Good
 Water Consumption: 3.20 litres/min
 Type of Product: Basin Taps and Mixers
 Brand: Axor
 Model: 39020E
 Reg no.: BST-2014/014592



✓✓✓ Excellent
 Water Consumption: 1.60 litres/min
 Type of Product: Basin Taps and Mixers
 Brand: Axor
 Model: 39020L
 Reg no.: BST-2014/014593

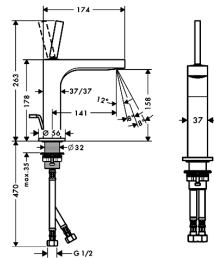

Single Lever Basin Mixer 180 mm DN15

- joystick cartridge
- adjustable QuickClean spray former
- pop-up waste set 1 1/4"
- suitable for continuous flow water heaters
- quality mark under application
- MWELS 2 ticks

Code No. 39031000E
Colour chrome



✓✓ Very Good
 Water Consumption: 3.80 litres/min
 Type of Product: Basin Taps and Mixers
 Brand: Axor
 Model: Citterio Single Lever Basin Mixer 39031E
 Reg no.: BST-2010/005419

Basin

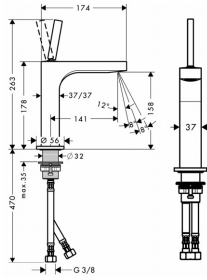

Single Lever Basin Mixer 180 with pop-up waste set

- ComfortZone 160, laminar spray
- adjustable spray former
- joystick ceramic cartridge
- temperature limitation not adjustable
- pop-up waste set G 1 1/4"
- suitable for continuous flow water heaters
- connection dimension: DN15
- MWELS 2 ticks & 3 ticks

Code No. 39032000E
 39032000L
Colour chrome



✓✓ Very Good
 Water Consumption: 3.10 litres/min
 Type of Product: Basin Taps and Mixers
 Brand: Axor
 Model: 39032E
 Reg no.: BST-2014/014594



✓✓✓ Excellent
 Water Consumption: 1.60 litres/min
 Type of Product: Basin Taps and Mixers
 Brand: Axor
 Model: 39032L
 Reg no.: BST-2014/014595

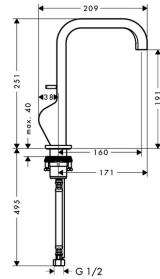

Single Lever Basin Mixer with pop-up waste set

- ComfortZone 160
- normal spray
- joystick ceramic cartridge
- temperature limitation not adjustable
- pop-up waste set G 1 1/4"
- suitable for continuous flow water heaters
- connection dimension: DN15
- MWELS 1 tick

Code No. 39034000
Colour chrome



✓ Good
 Water Consumption: 4.40 litres/min
 Type of Product: Basin Taps and Mixers
 Brand: Axor
 Model: Citterio Single Lever Basin Mixer 39034
 Reg no.: BST-2010/005421

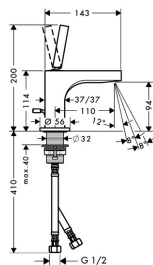

Single Lever Basin Mixer 115 mm for hand basins DN15

- joystick cartridge
- adjustable QuickClean spray former
- pop-up waste set 1 1/4"
- suitable for continuous flow water heaters
- quality mark under application
- MWELS 2 ticks

Code No. 39035000E
Colour chrome



✓✓ Very Good
 Water Consumption: 3.80 litres/min
 Type of Product: Basin Taps and Mixers
 Brand: Axor
 Model: Citterio Single Lever Basin Mixer Small 39035E
 Reg no.: BST-2010/005420

Basin

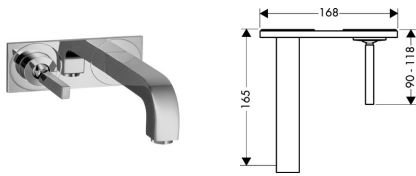

Single Lever Basin Mixer for concealed installation with plate and short spout DN15, wall mounting

- joystick cartridge
- QuickClean aerator
- flush grated waste
- suitable for continuous flow water heaters
- MWELS 1 tick, 2 ticks & 3 ticks for use with:
- basic set no.13622180

Code No. 39112000
 39112000E
 39112000L
Colour chrome



✓ Good
 Water Consumption: 4.80 litres/min
 Type of Product: Basin Taps and Mixers
 Brand: Axor
 Model: Citterio Wall Mounted Basin Mixer ShortSpout 39112
 Reg no.: BST-2009/003182



✓✓ Very Good
 Water Consumption: 2.70 litres/min
 Type of Product: Basin Taps and Mixers
 Brand: Axor
 Model: 39112E
 Reg no.: BST-2014/014596



✓✓✓ Excellent
 Water Consumption: 1.60 litres/min
 Type of Product: Basin Taps and Mixers
 Brand: Axor
 Model: 39112L
 Reg no.: BST-2014/014597

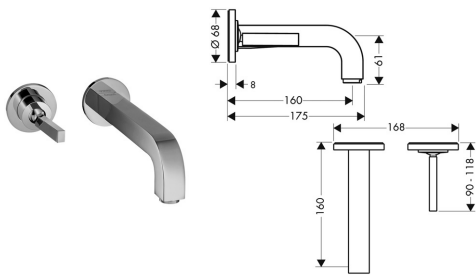

Single Lever Basin Mixer for concealed installation with spout 165mm and escutcheons wall-mounted

- projection 160mm, normal spray
- joystick ceramic cartridge
- temperature limitation not adjustable
- non-closing flush grated valve
- suitable for continuous flow water heaters
- connection dimension: DN15
- MWELS 1 tick, 2 ticks & 3 ticks

Code No. 39113000
 39113000E
 39113000L
Colour chrome



✓ Good
 Water Consumption: 4.90 litres/min
 Type of Product: Basin Taps and Mixers
 Brand: Axor
 Model: Citterio 39113
 Reg no.: BST-2014/014705



✓✓ Very Good
 Water Consumption: 3.00 litres/min
 Type of Product: Basin Taps and Mixers
 Brand: Axor
 Model: Citterio 39113E
 Reg no.: BST-2014/014706



✓✓✓ Excellent
 Water Consumption: 1.60 litres/min
 Type of Product: Basin Taps and Mixers
 Brand: Axor
 Model: Citterio 39113L
 Reg no.: BST-2014/014777

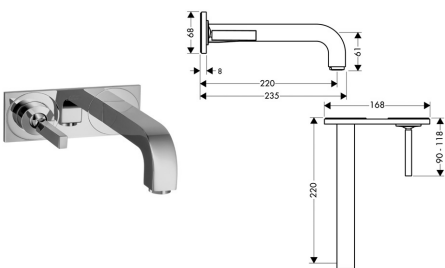

Single Lever Basin Mixer for concealed installation with spout 225mm and plate wall-mounted

- projection 160mm
- normal spray
- joystick ceramic cartridge
- temperature limitation not adjustable
- non-closing flush grated valve
- suitable for continuous flow water heaters
- connection dimension: DN15
- MWELS 1 tick, 2 ticks & 3 ticks

Code No. 39115000
 39115000E
 39115000L
Colour chrome



✓ Good
 Water Consumption: 5.10 litres/min
 Type of Product: Basin Taps and Mixers
 Brand: Axor
 Model: Citterio 39115
 Reg no.: BST-2014/014707



✓✓ Very Good
 Water Consumption: 2.90 litres/min
 Type of Product: Basin Taps and Mixers
 Brand: Axor
 Model: Citterio 39115E
 Reg no.: BST-2014/014708



✓✓✓ Excellent
 Water Consumption: 1.60 litres/min
 Type of Product: Basin Taps and Mixers
 Brand: Axor
 Model: Citterio 39115L
 Reg no.: BST-2014/014778

Basin

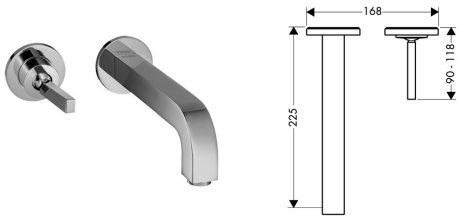

Single Lever Basin Mixer for concealed installation with escutcheons and long spout DN15, wall mounting

- joystick cartridge
 - QuickClean aerator
 - flush grated waste
 - suitable for continuous flow water heaters
 - MWELS 1 tick & 3 ticks
- for use with: basic set no.13622180

Code No. 39116000
 39116000L
Colour chrome



✓ Good
 Water Consumption: 4.80 litres/min
 Type of Product: Basin Taps and Mixers
 Brand: Axor
 Model: Citterio Wall Mounted Basin Mixer Long Spout 39116
 Reg no.: BST-2009/003183



✓✓✓ Excellent
 Water Consumption: 1.60 litres/min
 Type of Product: Basin Taps and Mixers
 Brand: Axor
 Model: Citterio 39116L
 Reg no.: BST-2014/014779

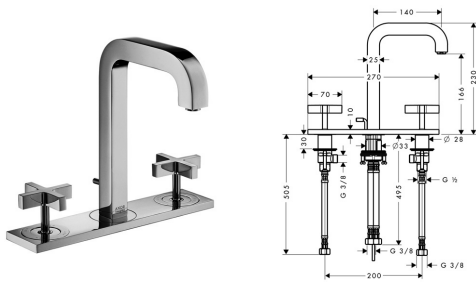

3-Hole Basin Mixer with cross handles, plate and short spout DN15

- ceramic valves hot/cold
- QuickClean aerator
- pop-up waste set 1 1/4"
- suitable for continuous flow water heaters
- with connection hoses
- MWELS 1 tick

Code No. 39134000
Colour chrome



✓ Good
 Water Consumption: 4.44 litres/min
 Type of Product: Basin Taps and Mixers
 Brand: Axor
 Model: Citterio Three Hole Basin Mixer Cross Handle 39134
 Reg no.: BST-2010/004202

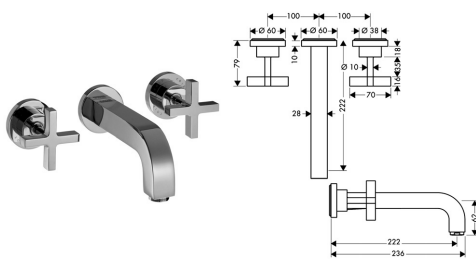

3-Hole Basin Mixer for concealed installation with cross handles, escutcheons and long spout DN15, wall mounting

- ceramic valves hot/cold
 - QuickClean aerator
 - flush grated waste
 - suitable for continuous flow water heaters
 - MWELS 1 tick
- for use with: basic set no.10303180

Code No. 39143000
Colour chrome



✓ Good
 Water Consumption: 4.96 litres/min
 Type of Product: Basin Taps and Mixers
 Brand: Axor
 Model: Citterio 3 Hole Basin Mixer Cross Handle 39143
 Reg no.: BST-2009/002909

Bath

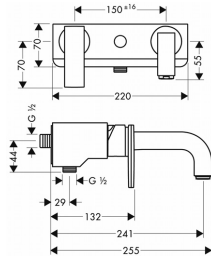

Single Lever Bath Mixer for exposed installation

- installation type: G¹/₂
- centre distance 150 ± 16mm
- projection: 255mm, normal spray
- ceramic cartridge, temperature limitation adjustable
- with automatic resetting
- non-return valve, with silencer
- no integrated shower support
- suitable for continuous flow water heaters
- connection dimension: DN15
- MWELS 1 tick

Code No. 39400000

Colour chrome



✓ Good

Water Consumption: 8.00 litres/min

Type of Product: Shower Taps and Mixers

Brand: Axor

Model: Citterio Single lever Exposed Bath Mixer 39400

Reg no.: SHT-2009/003758

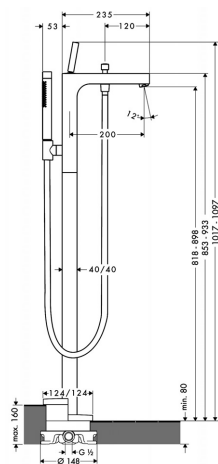

Free-standing Single Lever Bath Mixer DN15

- for mounting onto bathroom floor
 - joystick cartridge
 - non-return valve
 - button with stop/diverter valve to revert from shower to bath filler
 - with Axor Starck hand shower with Normal and Soft spray
 - shower hose 1.25m, diverter
 - MWELS 2 ticks
- for use with:
- basic set no.10452180
 - 6cm elevation no.97686000

Code No. 39451000

Colour chrome



✓✓ Very Good

Water Consumption: 6.40 litres/min

Type of Product: Shower Taps and Mixers

Brand: Axor

Model: Citterio Free Standing Bath Mixer 39451

Reg no.: SHT-2010/004530

Shower

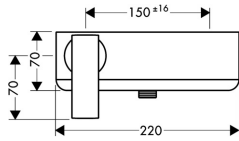

Single Lever Shower Mixer for exposed fitting DN15

- ceramic cartridge
- centre distance 150± 16mm
- non-return valve
- pipe connection DN15
- suitable for continuous flow water heaters
- MWELS 1 tick

Code No. 39600000

Colour chrome



✓ Good

Water Consumption: 7.40 litres/min

Type of Product: Shower Taps and Mixers

Brand: Axor

Model: Citterio Single Lever Exposed Shower Mixer 39600

Reg no.: SHT-2009/003760

Basin

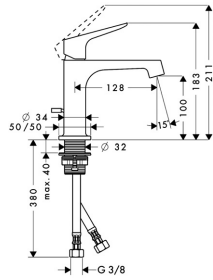

Single Lever Basin Mixer DN15

- ceramic cartridge
- pop-up waste set 1 1/4"
- suitable for continuous flow water heaters
- P-IX 18742/IO
- MWELS 1 tick, 2 ticks & 3 ticks

Code No. 34010000
 34010000E
 34010000L
Colour chrome



✓ Good
 Water Consumption: 5.00 litres/min
 Type of Product: Basin Taps and Mixers
 Brand: Axor
 Model: Citterio M
 Reg no.: BST-2009/001687



✓✓ Very Good
 Water Consumption: 3.20 litres/min
 Type of Product: Basin Taps and Mixers
 Brand: Axor
 Model: CITTERIO M 34010E
 Reg no.: BST-2013/012404



✓✓✓ Excellent
 Water Consumption: 1.60 litres/min
 Type of Product: Basin Taps and Mixers
 Brand: Axor
 Model: CITTERIO M 34010L
 Reg no.: BST-2013/012418

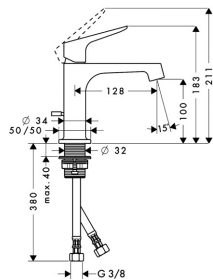

Single Lever Basin Mixer DN15

- ceramic cartridge
- pop-up waste set 1 1/4"
- suitable for continuous flow water heaters
- P-IX 18742/IO
- MWELS 1 tick, 2 ticks & 3 ticks

Code No. 34017000
 34017000E
 34017000L
Colour chrome



✓ Good
 Water Consumption: 4.70 litres/min
 Type of Product: Basin Taps and Mixers
 Brand: Axor
 Model: Citterio M 34017
 Reg no.: BST-2014/014527



✓✓ Very Good
 Water Consumption: 3.10 litres/min
 Type of Product: Basin Taps and Mixers
 Brand: Axor
 Model: Citterio 34017E
 Reg no.: BST-2014/014528



✓✓✓ Excellent
 Water Consumption: 1.60 litres/min
 Type of Product: Basin Taps and Mixers
 Brand: Axor
 Model: Citterio 34017L
 Reg no.: BST-2014/014604

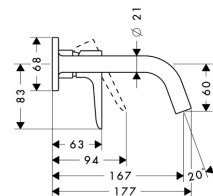

Single Lever Basin Mixer for concealed installation with plate and short spout DN15, wall mounting

- ceramic cartridge
- flush grated waste
- suitable for continuous flow water heaters
- MWELS 2 ticks
- for use with:
- basic set no.13622180

Code No. 34112000E
Colour chrome



✓✓ Very Good
 Water Consumption: 3.30 litres/min
 Type of Product: Basin Taps and Mixers
 Brand: Axor
 Model: Citterio M Wall Mounted Basin Mixer Plate 34112
 Reg no.: BST-2010/003947

Basin

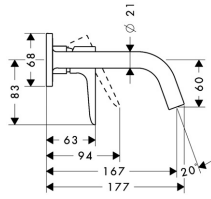

Single Lever Basin Mixer for concealed installation with escutcheons and short spout DN15

- ceramic cartridge
 - flush grated waste
 - suitable for continuous flow water heaters
 - MWELS 2 ticks
- for use with:
- basic set no.13622180

Code No. 34113000E
Colour chrome



✓✓ Very Good
 Water Consumption: 3.50 litres/min
 Type of Product: Basin Taps and Mixers
 Brand: Axor
 Model: Citterio M Wall Basin Mixer
 Escutcheon 34113
 Reg no.: BST-2010/003946

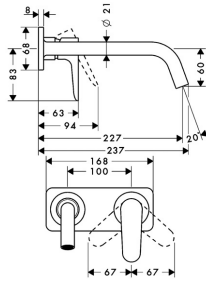

Single Lever Basin Mixer for concealed installation with plate and spout 227mm DN15, wall mounting

- ceramic cartridge
 - flush grated waste
 - suitable for continuous flow water heaters
 - MWELS 1 tick & 2 ticks
- for use with:
- basic set no.13622180

Code No. 34115000
 34115000E
Colour chrome



✓ Good
 Water Consumption: 5.00 litres/min
 Type of Product: Basin Taps and Mixers
 Brand: Axor
 Model: Citterio M Wall Mounted
 Basin Mixer Plate 34115
 Reg no.: BST-2011/007974



✓✓ Very Good
 Water Consumption: 3.20 litres/min
 Type of Product: Basin Taps and Mixers
 Brand: Axor
 Model: Citterio M Wall Mounted
 Basin Mixer Plate 34115E
 Reg no.: BST-2011/007979

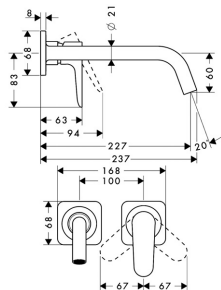

Single Lever Basin Mixer for concealed installation with escutcheons and spout 227mm DN15, wall mounting

- ceramic cartridge
 - flow limiter 5 l/min
 - flush grated waste
 - suitable for continuous flow water heaters
 - MWELS 2 ticks
- for use with:
- basic set no.13622180

Code No. 34116000E
Colour chrome



✓✓ Very Good
 Water Consumption: 3.30 litres/min
 Type of Product: Basin Taps and Mixers
 Brand: Axor
 Model: Citterio M Wall Mounted
 Basin Mixer 34116E
 Reg no.: BST-2011/007283

Basin

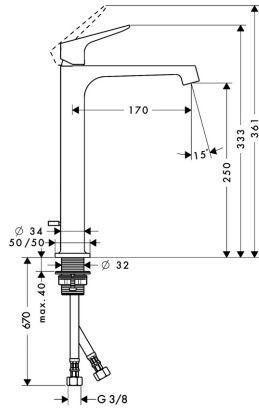

Code No. 34120000

Colour chrome

Single Lever Basin Mixer for wash bowls DN15

- ceramic cartridge
- pop-up waste set 1 1/4"
- suitable for continuous flow water heaters
- MWELS 1 tick



✓ Good

Water Consumption: 4.80 litres/min

Type of Product: Basin Taps and Mixers

Brand: Axor

Model: Citterio M Highriser Basin Mixer 34120

Reg no.: BST-2009/002704

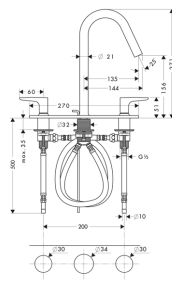

Code No. 34134000E

34134000L

Colour chrome

3-Hole Basin Mixer with pop-up waste set, lever handles and plate

- ComfortZone 160
- projection 135 mm
- normal spray
- only for use on level, smooth surfaces
- ceramic valves hot / cold 90°
- temperature limitation not adjustable
- pop-up waste set G 1 1/4"
- suitable for continuous flow water heaters
- connection dimension: DN15
- MWELS 2 ticks & 3 ticks



✓✓ Very Good

Water Consumption: 3.40 litres/min

Type of Product: Basin Taps and Mixers

Brand: Axor

Model: Citterio M 34134E

Registration no.: BST-2015/016841



✓✓✓ Excellent

Water Consumption: 1.80 litres/min

Type of Product: Basin Taps and Mixers

Brand: Axor

Model: Citterio M 34134L

Registration no.: BST-2015/016864

Basin

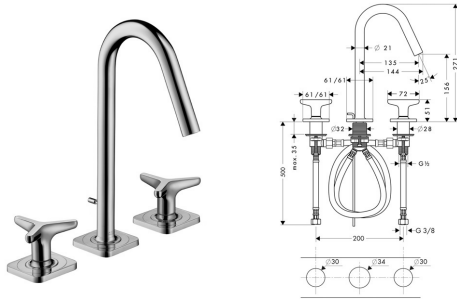

3-Hole Basin Mixer with star handles and escutcheons, DN15

- ceramic valves hot/cold 180°
- pop-up waste set 1 1/4"
- suitable for continuous flow water heaters
- with connection hoses
- MWELS 1 tick, 2 ticks & 3 ticks for free positioning of spout / handles:
- Hose extension set 3-Hole no.38959000

Code No. 34135000
 34135000E
 34135000L

Colour chrome



✓ Good
 Water Consumption: 5.20 litres/min
 Type of Product: Basin Taps and Mixers
 Brand: Axor
 Model: Citterio M 34135
 Registration no.: BST-2015/016866



✓✓ Very Good
 Water Consumption: 3.00 litres/min
 Type of Product: Basin Taps and Mixers
 Brand: Axor
 Model: Citterio M 34135E
 Registration no.: BST-2015/016867



✓✓✓ Excellent
 Water Consumption: 1.60 litres/min
 Type of Product: Basin Taps and Mixers
 Brand: Axor
 Model: Citterio M 34135L
 Registration no.: BST-2015/016900

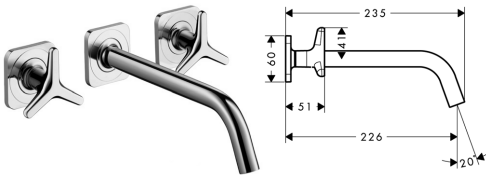

3-Hole Basin Mixer for concealed installation with star handles, escutcheons and spout 226mm DN15, wall mounting

- ceramic valves hot/cold 180°
- flush grated valve
- suitable for continuous flow water heaters
- MWELS 1 tick, 2 ticks & 3 ticks for use with:
- basic set no.10303180

Code No. 34217000
 34217000E
 34217000L

Colour chrome



✓ Good
 Water Consumption: 5.70 litres/min
 Type of Product: Basin Taps and Mixers
 Brand: Axor
 Model: 34217
 Reg no.: BST-2014/015814



✓✓ Very Good
 Water Consumption: 3.00 litres/min
 Type of Product: Basin Taps and Mixers
 Brand: Axor
 Model: 34217E
 Reg no.: BST-2014/015815



✓✓✓ Excellent
 Water Consumption: 1.60 litres/min
 Type of Product: Basin Taps and Mixers
 Brand: Axor
 Model: 34217L
 Reg no.: BST-2014/015816

Basin

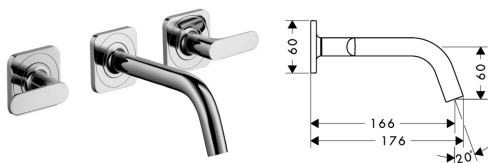

3-Hole Basin Mixer for concealed installation with escutcheons and spout 166mm DN15, wall mounting

- ceramic valves hot/cold 90°
 - flush grated valve
 - suitable for continuous flow water heaters
 - MWELS 2 ticks
- for use with:
- basic set no.10303180

Code No. 34313000E

Colour chrome



✓✓ Very Good

Water Consumption: 3.30 litres/min
 Type of Product: Basin Taps and Mixers
 Brand: Axor
 Model: Citterio M Three Hole Wall
 Basin Mixer Esc 34313E
 Reg no.: BST-2010/005746

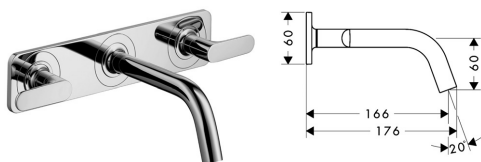

3-Hole Basin Mixer for concealed installation with plate and spout 166mm DN15, wall mounting

- ceramic valves hot/cold 90°
 - flush grated valve
 - suitable for continuous flow water heaters
 - MWELS 2 ticks
- for use with:
- basic set no.10303180

Code No. 34314000E

Colour chrome



✓✓ Very Good

Water Consumption: 3.80 litres/min
 Type of Product: Basin Taps and Mixers
 Brand: Axor
 Model: Citterio M Three Hole Wall
 Basin Mixer Plate34314E
 Reg no.: BST-2010/005747

Bath

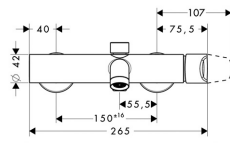

Single Lever Bath Mixer for exposed fitting DN15

- ceramic cartridge
- flow rate approx. 22 l/min.
- centre distance 150 ± 16mm
- non-return valve
- button with stop/diverter valve to revert from shower to bath filler, shower outlet DN15
- suitable for continuous flow water heaters
- MWELS 1 tick

Code No. 34420000

Colour chrome



✓ Good

Water Consumption: 7.50 litres/min

Type of Product: Shower Taps and Mixers

Brand: Axor

Model: Citterio M Exposed Bath Mixer 34420

Reg no.: SHT-2011/007012

Shower

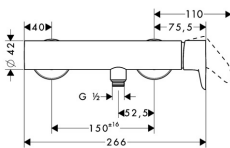

Single Lever Shower Mixer for exposed fitting DN15

- ceramic cartridge
- centre distance 150± 16mm
- non-return valve
- pipe connection DN15
- suitable for continuous flow water heaters
- MWELS 1 tick

Code No. 34620000

Colour chrome



✓ Good

Water Consumption: 7.50 litres/min

Type of Product: Shower Taps and Mixers

Brand: Axor

Model: Citterio M Exposed Shower Mixer 34620

Reg no.: SHT-2010/004523

Basin

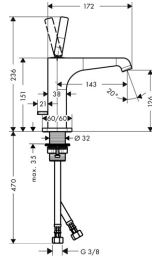

Single Lever Basin Mixer 150

- ComfortZone 125
- projection 143 mm
- laminar spray
- joystick ceramic cartridge
- temperature limitation not adjustable
- pop-up waste set G 1 1/4
- suitable for continuous flow water heaters
- connection dimension: DN15
- MWELS 1 tick & 2 ticks

Code No. 36100000
 36100000E
Colour chrome



✓ Good
 Water Consumption: 4.40 litres/min
 Type of Product: Basin Taps and Mixers
 Brand: Axor
 Model: Citterio E 36100
 Registration No.: BST-2015/017620



✓✓ Very Good
 Water Consumption: 2.20 litres/min
 Type of Product: Basin Taps and Mixers
 Brand: Axor
 Model: Citterio E 36100E
 Registration No.: BST-2015/017621

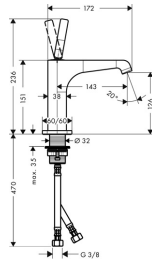

Single Lever Basin Mixer 150 without pull-rod

- ComfortZone 125
- projection 143 mm
- laminar spray
- joystick ceramic cartridge
- temperature limitation not adjustable
- pop-up waste set G 1 1/4
- suitable for continuous flow water heaters
- connection dimension: DN15
- MWELS 1 tick & 2 ticks

Code No. 36101000
 36101000E
Colour chrome



✓ Good
 Water Consumption: 4.90 litres/min
 Type of Product: Basin Taps and Mixers
 Brand: Axor
 Model: Citterio E 36101
 Registration No.: BST-2015/017622



✓✓ Very Good
 Water Consumption: 3.10 litres/min
 Type of Product: Basin Taps and Mixers
 Brand: Axor
 Model: Citterio E 36101E
 Registration No.: BST-2015/017623

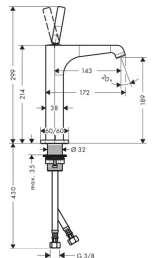

Single Lever Basin Mixer 215 for wash bowl without pull-rod DN15

- ComfortZone 190
- projection 143 mm
- laminar spray
- joystick ceramic cartridge
- temperature limitation not adjustable
- non-closing flush grated valve
- suitable for continuous flow water heaters
- connection dimension: DN15
- MWELS 1 tick & 2 ticks

Code No. 36103000
 36103000E
Colour chrome



✓ Good
 Water Consumption: 4.40 litres/min
 Type of Product: Basin Taps and Mixers
 Brand: Axor
 Model: Citterio E 36103
 Registration No.: BST-2015/017624



✓✓ Very Good
 Water Consumption: 2.50 litres/min
 Type of Product: Basin Taps and Mixers
 Brand: Axor
 Model: Citterio E 36103E
 Registration No.: BST-2015/017625

Basin

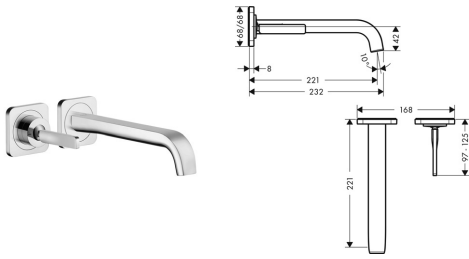

Single Lever Basin Mixer for concealed installation spout 220 mm wall mounting

- projection 220 mm
- laminar spray
- joystick ceramic cartridge
- temperature limitation not adjustable
- scope of supply: escutcheons, spout, handle, sleeve
- non-closing flush grated valve
- suitable for continuous flow water heaters
- handle can be positioned on the right or left, depends on the basic set installation
- MWELS 1 tick & 2 ticks

Code No. 36106000
 36106000E
Colour chrome



✓ **Good**
 Water Consumption: 4.40 litres/min
 Type of Product: Basin Taps and Mixers
 Brand: Axor
 Model: Citterio E 36106
 Registration No.: BST-2015/017626



✓✓ **Very Good**
 Water Consumption: 2.50 litres/min
 Type of Product: Basin Taps and Mixers
 Brand: Axor
 Model: Citterio E 36106E
 Registration No.: BST-2015/017627

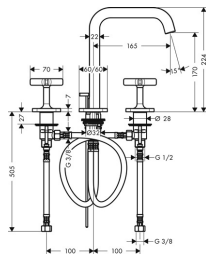

3-Hole Basin Mixer

- ComfortZone 170
- projection 165 mm
- laminar spray
- ceramic valves hot/ cold 180°
- pop-up waste set G 1 1/4
- suitable for continuous flow water heaters
- connection dimension: DN15
- MWELS 1 tick & 2 ticks

Code No. 36108000
 36108000E
Colour chrome



✓ **Good**
 Water Consumption: 4.40 litres/min
 Type of Product: Basin Taps and Mixers
 Brand: Axor
 Model: Citterio E 36108
 Registration No.: BST-2015/017628



✓✓ **Very Good**
 Water Consumption: 2.70 litres/min
 Type of Product: Basin Taps and Mixers
 Brand: Axor
 Model: Citterio E 36108E
 Registration No.: BST-2015/017629

Basin

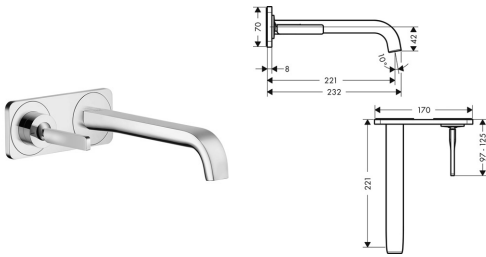

Single lever basin mixer for concealed installation spout 220 mm wall mounting

- projection 220 mm
- laminar spray
- joystick ceramic cartridge
- temperature limitation not adjustable
- scope of supply: spout, handle, sleeve, mounting plate
- non-closing flush grated valve
- suitable for continuous flow water heaters
- handle can be positioned on the right or left, depends on the basic set installation
- MWELS 1 tick & 2 ticks

Code No. 36114000
 36114000E
Colour chrome



✓ **Good**
 Water Consumption: 4.40 litres/min
 Type of Product: Basin Taps and Mixers
 Brand: Axor
 Model: Citterio E 36114
 Registration No.: BST-2015/017630



✓✓ **Very Good**
 Water Consumption: 2.50 litres/min
 Type of Product: Basin Taps and Mixers
 Brand: Axor
 Model: Citterio E 36114E
 Registration No.: BST-2015/017631

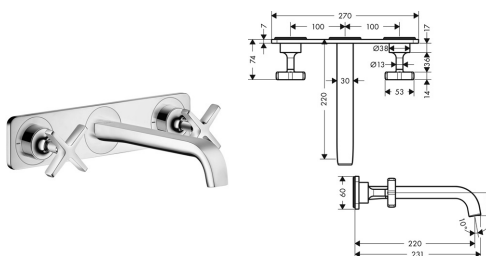

3-hole basin mixer for concealed installation spout 220 mm wall mounting

- projection 220 mm
- laminar spray
- ceramic valves hot/ cold 180°
- temperature limitation not adjustable
- non-closing flush grated valve
- suitable for continuous flow water heaters
- connection dimension: DN15
- MWELS 1 tick & 2 ticks

Code No. 36115000
 36115000E
Colour chrome



✓ **Good**
 Water Consumption: 4.40 litres/min
 Type of Product: Basin Taps and Mixers
 Brand: Axor
 Model: Citterio E 36115
 Registration No.: BST-2015/017632



✓✓ **Very Good**
 Water Consumption: 2.40 litres/min
 Type of Product: Basin Taps and Mixers
 Brand: Axor
 Model: Citterio E 36115E
 Registration No.: BST-2015/017633

Basin

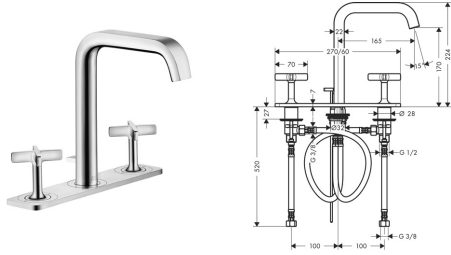

3-hole basin mixer with plate

- ComfortZone 170
- projection 165 mm
- laminar spray
- only for use on level, smooth surfaces
- ceramic valves hot/ cold 180°
- pop-up waste set G 1 1/4
- suitable for continuous flow water heaters
- connection dimension: DN15
- MWELS 1 tick & 2 ticks

Code No. 36116000
 36116000E
Colour chrome



✓ Good
 Water Consumption: 4.20 litres/min
 Type of Product: Basin Taps and Mixers
 Brand: Axor
 Model: Citterio E 36116
 Registration No.: BST-2015/017634



✓✓ Very Good
 Water Consumption: 2.40 litres/min
 Type of Product: Basin Taps and Mixers
 Brand: Axor
 Model: Citterio E 36116E
 Registration No.: BST-2015/017635

Bath

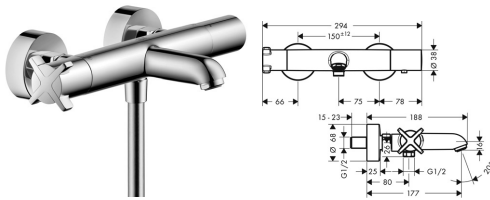

Thermostatic bath mixer for exposed installation

- projection 185 mm
- 2 outlets
- will not run two outlets at same time
- thermostat cartridge, shut-off/ diverter valve
- safety lock at 40°
- temperature limitation adjustable
- spray type: normal spray
- non-return valve
- with silencer
- centre distance 150 mm ± 16 mm
- scope of supply: escutcheons
- connection dimension: DN15
- connection type: s-shaped connections
- MWELS 1 tick & 2 ticks

Code No. 36140000
 36140000E
Colour chrome



✓ Good
 Water Consumption: 7.50 litres/min
 Type of Product: Shower Taps and Mixers
 Brand: Axor
 Model: Citterio E 36140
 Registration No.: SHT-2015/017637



✓✓ Very Good
 Water Consumption: 5.50 litres/min
 Type of Product: Shower Taps and Mixers
 Brand: Axor
 Model: Citterio E 36140E
 Registration No.: SHT-2015/017638

Shower

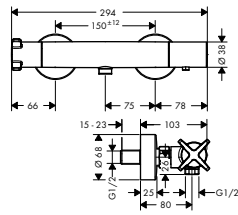

Thermostatic shower mixer for exposed installation

- 1 outlet
- thermostat cartridge, ceramic valve 180°
- safety lock at 40° C
- temperature limitation adjustable
- scope of supply: escutcheons
- non-return valve
- with silencer
- centre distance: 150 mm ± 12 mm
- connection dimension: DN15
- MWELS 1 tick & 2 ticks

Code No. 36160000
 36160000E
Colour chrome



✓ Good
 Water Consumption: 7.50 litres/min
 Type of Product: Shower Taps and Mixers
 Brand: Axor
 Model: Citterio E 36160
 Registration No.: SHT-2015/017639



✓✓ Very Good
 Water Consumption: 5.70 litres/min
 Type of Product: Shower Taps and Mixers
 Brand: Axor
 Model: Citterio E 36160E
 Registration No.: SHT-2015/017640

Basin

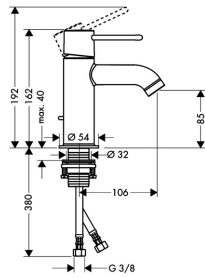

Single Lever Basin Mixer DN15

- ceramic cartridge
- QuickClean aerator
- pop-up waste set 1 1/4"
- suitable for continuous flow water heaters
- MWELS 1 tick

Code No. 38020000

Colour chrome



✓ Good

Water Consumption: 5.00 litres/min

Type of Product: Basin Taps and Mixers

Brand: Axor

Model: Uno 2 Single Lever Basin Mixer 38020

Reg no.: BST-2010/005566

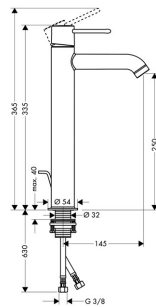

Single Lever Basin Mixer for wash bowls DN15

- ceramic cartridge
- QuickClean aerator
- pop-up waste set G 1 1/4"
- suitable for continuous flow water heaters
- MWELS 1 tick

Code No. 38025000

Colour chrome



✓ Good

Water Consumption: 5.40 litres/min

Type of Product: Basin Taps and Mixers

Brand: Axor

Model: Uno 2 Single Lever Highriser Basin Mixer 38025

Reg no.: BST-2011/007973

Basin

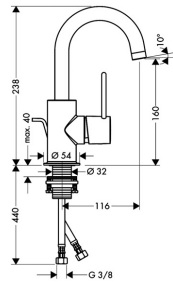

Single Lever Basin Mixer for hand basins with high swivel spout DN15

- swivel spout 360°
- ceramic cartridge
- pop-up waste set 1 1/4"
- suitable for continuous flow water heaters
- MWELS 1 tick

Code No. 38035000

Colour chrome



✓ Good
 Water Consumption: 4.20 litres/min
 Type of Product: Basin Taps and Mixers
 Brand: Axor
 Model: Uno 2
 Reg no.: BST-2009/001406

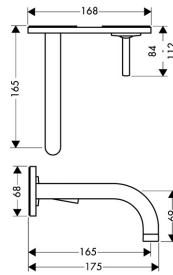

Single Lever Basin Mixer for concealed installation with plate and short spout DN15

- finish set for wall mounting, joystick cartridge
 - flush grated waste
 - suitable for continuous flow water heaters
 - MWELS 2 ticks
- for use with:
- basic set no.13622180

Code No. 38112000E

Colour chrome



✓✓ Very Good
 Water Consumption: 3.30 litres/min
 Type of Product: Basin Taps and Mixers
 Brand: Axor
 Model: Uno 2 Wall Mounted Basin Mixer Plate 38112E
 Reg no.: BST-2010/004565

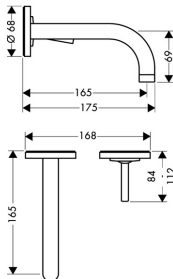

Single Lever Basin Mixer for concealed installation with escutcheons and short spout DN15

- finish set for wall mounting
 - joystick cartridge
 - suitable for continuous flow water heaters
 - MWELS 2 ticks
- for use with:
- basic set no.13622180

Code No. 38113000E

Colour chrome



✓✓ Very Good
 Water Consumption: 3.30 litres/min
 Type of Product: Basin Taps and Mixers
 Brand: Axor
 Model: Uno 2 Wall Mounted Basin Mixer 38113E
 Reg no.: BST-2010/004564

Basin

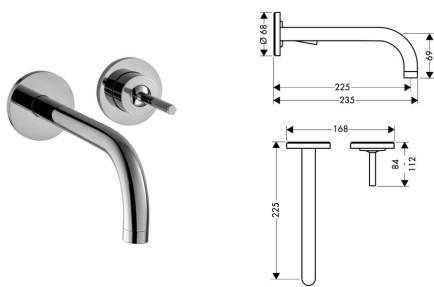

Single Lever Basin Mixer for concealed installation with escutcheons and long spout DN15

- finish set for wall mounting, joystick cartridge
 - flush grated waste
 - suitable for continuous flow water heaters
 - MWELS 1 tick
- for use with:
- basic set no.13622180

Code No. 38116000

Colour chrome



✓ Good
 Water Consumption: 4.60 litres/min
 Type of Product: Basin Taps and Mixers
 Brand: Axor
 Model: Uno 2 Wall Mounted Basin Mixer
 Escutcheon 38116
 Reg no.: BST-2010/005034

Bath

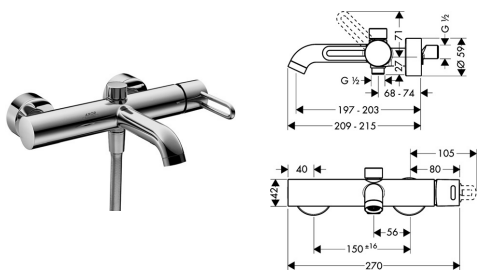

Single Lever Bath Mixer for exposed fitting DN15

- ceramic cartridge
- centre distance 150± 16mm
- non-return valve
- button with stop/diverter valve to revert from shower to bath filler
- hose connection DN15
- suitable for continuous flow water heaters
- MWELS 1 tick

Code No. 38420000

Colour chrome



✓ Good
 Water Consumption: 7.20 litres/min
 Type of Product: Shower Taps and Mixers
 Brand: Axor
 Model: Uno 2 Single Lever Bath Mixer 38420
 Reg no.: SHT-2010/005476

Shower

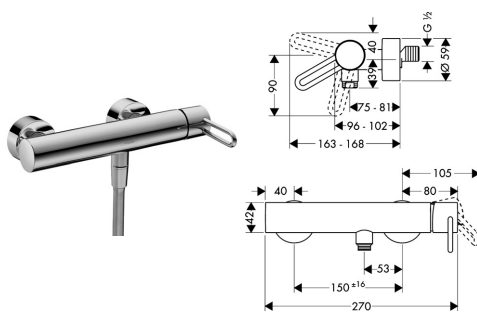

Single Lever Shower Mixer for exposed fitting DN15

- ceramic cartridge
- centre distance 150± 16mm
- non-return valve
- hose connection DN15
- for continuous flow water heaters
- MWELS 1 tick

Code No. 38620000

Colour chrome



✓ Good
 Water Consumption: 7.20 litres/min
 Type of Product: Shower Taps and Mixers
 Brand: Axor
 Model: Uno 2 Single Lever Exposed Shower Mixer 38620
 Reg no.: SHT-2009/003431

Basin

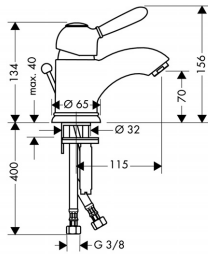

Single Lever Basin Mixer DN15

- ceramic cartridge
- QuickClean aerator
- pop-up waste set 1 1/4"
- suitable for continuous flow water heaters
- flexible connection hoses
- MWELS 1 tick

Code No. 17010000
 17010090
Colour chrome
 chrome/goldptic



✓ Good
 Water Consumption: 4.20 litres/min
 Type of Product: Basin Taps and Mixers
 Brand: Axor
 Model: Carlton Single Lever Basin Mixer 17010
 Reg no.: BST-2009/003430

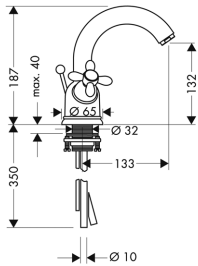

2-handle basin mixer with pop-up waste set, swivel spout and copper pipes

- ComfortZone 130
- projection 133 mm
- normal spray
- ceramic valves hot/ cold 180°
- temperature limitation not adjustable
- pop-up waste set G 1 1/4
- suitable for continuous flow water heaters
- connection dimension: DN15
- MWELS 1 tick & 2 ticks

Code No. 17030000
 17030000E

Colour chrome
 chrome/goldptic



✓ Good
 Water Consumption: 4.50 litres/min
 Type of Product: Basin Taps and Mixers
 Brand: Axor
 Model: Carlton 17030000
 Registration no.: BST-2015/016708



✓✓ Very Good
 Water Consumption: 3.10 litres/min
 Type of Product: Basin Taps and Mixers
 Brand: Axor
 Model: Carlton 17030E
 Registration no.: BST-2015/016709

Basin

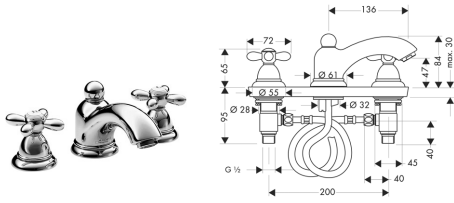

**3-hole basin mixer
 with pop-up waste set
 and cross handles**

- ComfortZone 50
- projection 136 mm
- normal spray
- ceramic valves hot/ cold 180°
- temperature limitation not adjustable
- pop-up waste set G 1 1/4
- suitable for continuous flow water heaters
- connection dimension: DN15
- MWELS 1 tick & 2 ticks

Code No. 17133000
 17133000E

Colour chrome
 chrome/goldoptic



✓ Good
 Water Consumption: 4.50 litres/min
 Type of Product: Basin Taps and Mixers
 Brand: Axor
 Model: Carlton 17133
 Registration no.: BST-2015/017740



✓✓ Very Good
 Water Consumption: 2.30 litres/min
 Type of Product: Basin Taps and Mixers
 Brand: Axor
 Model: Carlton 17133E
 Registration no.: BST-2015/017741

Basin

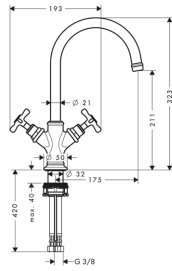

2-Handle Basin Mixer with pop-up waste set

- ComfortZone 210
- projection 175mm
- normal spray
- ceramic valves hot/cold 180°
- temperature limitation not adjustable
- pop-up waste set G 1 1/4
- suitable for continuous flow water heaters
- swivel range 120°
- connection dimension: DN15
- MWELS 1 tick & 2 ticks

Code No. 16502000
 16502000E
Colour chrome
 brushed nickel
 polished nickel



✓ Good
 Water Consumption: 4.50 litres/min
 Type of Product: Basin Taps and Mixers
 Brand: Axor
 Model: Montreux 16502000
 Registration no.: BST-2015/016706



✓✓ Very Good
 Water Consumption: 2.90 litres/min
 Type of Product: Basin Taps and Mixers
 Brand: Axor
 Model: Montreux 16502E
 Registration no.: BST-2015/016707

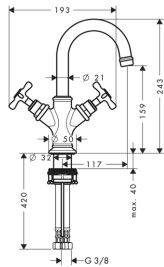

2-Handle Basin Mixer with pop-up waste set for hand washbasins

- ComfortZone 160
- projection 117mm
- normal spray
- ceramic valves hot/cold 180°
- temperature limitation not adjustable
- pop-up waste set G 1 1/4
- suitable for continuous flow water heaters
- swivel range 120°
- connection dimension: DN15
- MWELS 1 tick & 2 ticks

Code No. 16505000
 16505000E
Colour chrome
 brushed nickel
 polished nickel



✓ Good
 Water Consumption: 5.00 litres/min
 Type of Product: Basin Taps and Mixers
 Brand: Axor
 Model: Montreux 16505000
 Registration no.: BST-2015/016704



✓✓ Very Good
 Water Consumption: 3.00 litres/min
 Type of Product: Basin Taps and Mixers
 Brand: Axor
 Model: Montreux 16505E
 Registration no.: BST-2015/016705

Basin

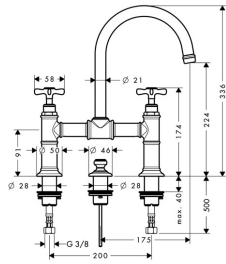

2-Handle Basin Mixer DN15

- bridge mixer
- swivel area 120°
- ceramic valves hot/cold
- pop-up waste set 1 1/4"
- suitable for continuous flow water heaters
- MWELS 1 tick

Code No. 16510000
 16510820
 16510830

Colour chrome
 brushed nickel
 polished nickel



✓ Good
 Water Consumption: 4.90 litres/min
 Type of Product: Basin Taps and Mixers
 Brand: Axor
 Model: Montreux Two Handle Basin Mixer 16510
 Reg no.: BST-2009/003771

Bath

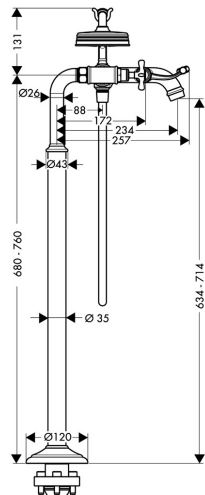

2-Handle Bath Mixer, free-standing DN15

- for mounting on the bathroom floor
 - ceramic valves hot/cold
 - with Axor Montreux hand shower
 - metal shower hose 1.25m
 - button with stop/diverter valve to revert from shower to bath filler
 - hose connection 3/8"
 - non-return valve
 - suitable for continuous flow water heaters
 - MWELS 1 tick
- for use with:
- basic set no.16549180

Code No. 16547000
 16547820
 16547830

Colour chrome
 brushed nickel
 polished nickel



✓ Good
 Water Consumption: 7.62 litres/min
 Type of Product: Shower Taps and Mixers
 Brand: Axor
 Model: Montreux Free Standing Bath Mixer 16547
 Reg no.: SHT-2009/003846

Metris

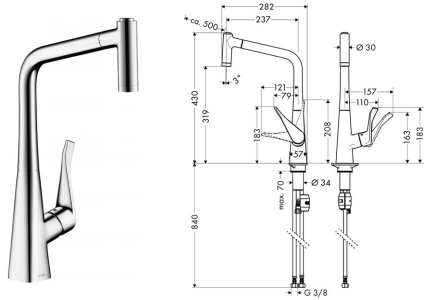

Single Lever Kitchen Mixer with pull-out spray

- swivel range 110° / 150°
- vertical handle position
- laminar spray and shower spray
- lockable shower spray, spray returns automatically through handle closing
- MagFit magnetic shower support
- quick connect shower hose
- connection dimension: DN15
- ceramic cartridge
- G 3/8 connections
- integrated non-return valve
- suitable for continuous flow water heaters
- MWELS 1 tick, 2 ticks & 3 ticks

Code No. 14820000
14820800
14820000E
14820800E
14820000L
14820800L

Colour chrome
stainless steel optic



✓ **Good**
Water Consumption: 7.70 litres/min
Type of Product: Sink/Bib Taps and Mixers
Brand: Hansgrohe
Model: 14820
Reg no.: SKT/BT-2014/014365



✓✓ **Very Good**
Water Consumption: 4.70 litres/min
Type of Product: Sink/Bib Taps and Mixers
Brand: Hansgrohe
Model: 14820E
Reg no.: SKT/BT-2014/014366



✓✓✓ **Excellent**
Water Consumption: 2.70 litres/min
Type of Product: Sink/Bib Taps and Mixers
Brand: Hansgrohe
Model: 14820L
Reg no.: SKT/BT-2014/014367

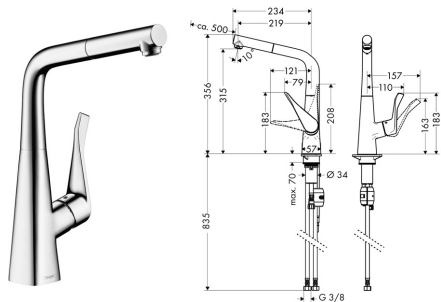

Single Lever Kitchen Mixer with pull-out spout

- swivel range 110° / 150°
- vertical handle position
- laminar spray
- MagFit magnetic shower support
- quick connect shower hose
- connection dimension: DN15
- ceramic cartridge
- G 3/8 connections
- integrated non-return valve
- suitable for continuous flow water heaters
- MWELS 1 tick, 2 ticks & 3 ticks

Code No. 14821000
14821800
14821000E
14821800E
14821000L
14821800L

Colour chrome
stainless steel optic



✓ **Good**
Water Consumption: 7.40 litres/min
Type of Product: Sink/Bib Taps and Mixers
Brand: Hansgrohe
Model: 14821
Reg no.: SKT/BT-2014/014371



✓✓ **Very Good**
Water Consumption: 4.70 litres/min
Type of Product: Sink/Bib Taps and Mixers
Brand: Hansgrohe
Model: 14821E
Reg no.: SKT/BT-2014/014372



✓✓✓ **Excellent**
Water Consumption: 2.90 litres/min
Type of Product: Sink/Bib Taps and Mixers
Brand: Hansgrohe
Model: 14821L
Reg no.: SKT/BT-2014/014373

Metris

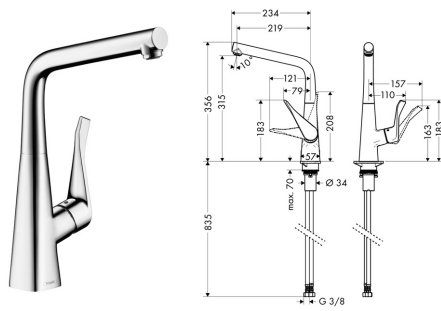

Single Lever Kitchen Mixer with swivel spout

- swivel range adjustable in 3 steps 110°, 150° or 360°
- vertical handle position
- laminar spray
- connection dimension: DN15
- ceramic cartridge
- G 3/8 connections
- suitable for continuous flow water heaters
- MWELS 1 tick, 2 ticks & 3 ticks

Code No. 14822000
14822800
14822000E
14822800E
14822000L
14822800L

Colour chrome
stainless steel optic



✓ **Good**
Water Consumption: 7.40 litres/min
Type of Product: Sink/Bib Taps and Mixers

Brand: Hansgrohe
Model: 14822
Reg no.: SKT/BT-2014/014368



✓✓ **Very Good**
Water Consumption: 4.70 litres/min
Type of Product: Sink/Bib Taps and Mixers

Brand: Hansgrohe
Model: 14822E
Reg no.: SKT/BT-2014/014369



✓✓✓ **Excellent**
Water Consumption: 3.10 litres/min
Type of Product: Sink/Bib Taps and Mixers

Brand: Hansgrohe
Model: 14822L
Reg no.: SKT/BT-2014/014370

Metris Select

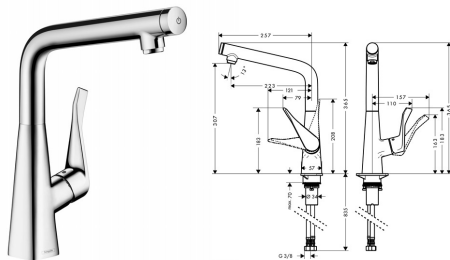

Single Lever Kitchen Mixer with swivel spout

- swivel range adjustable in 3 steps 110°, 150° or 360°
- vertical handle position
- laminar spray
- Select button for a comfortable start/stop of the water flow
- connection dimension: DN15
- ceramic cartridge
- connection type: G 3/8 connections
- integrated non-return valve
- suitable for continuous flow water heaters
- operating pressure min. 1 bar / max. 10 bar
- MWELS 2 ticks

Code No. 14883000E
Colour chrome
stainless steel optic



✓✓ **Very Good**
Water Consumption: 4.60 litres/min
Type of Product: Sink/Bib Taps and Mixers

Brand: Hansgrohe
Model: 14883E
Reg no.: SKT/BT-2015/017800

Talis S

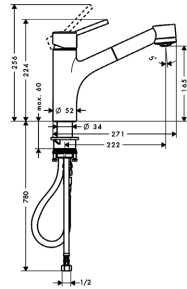

Single Lever Kitchen Mixer DN15 with pull-out spray

- QuickClean system
- ceramic cartridge, Boltic lever lock
- swivel spout 150°
- Normal and spray jet (non-arresting)
- non-return valve
- MWELS 2 ticks

Code No. 32841000E

Colour chrome



✓✓ Very Good

Water Consumption: 4.10 litres/min
Type of Product: Sink/Bib Taps and Mixers

Brand: Hansgrohe
Model: Talis S Kitchen Mixer With Pull Out 32841E
Reg no.: SKT/BT-2010/004528

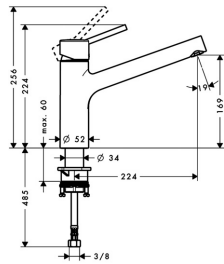

Single Lever Kitchen Mixer DN15

- QuickClean system
- ceramic cartridge, Boltic lever lock
- swivel spout 150°
- MWELS 1 tick

Code No. 32851000

Colour chrome



✓ Good

Water Consumption: 6.90 litres/min
Type of Product: Sink/Bib Taps and Mixers
Brand: Hansgrohe

Model: Talis 'S' Single Lever Kitchen Mixer 32851
Reg no.: SKT/BT-2009/003428

Talis S² Variarc

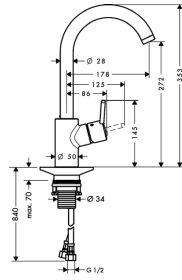

Single Lever Kitchen Mixer

- swivel range adjustable in 3 steps 110°, 150° or 360°
- normal spray
- connection dimension: DN15
- ceramic cartridge
- G^{3/8} connections
- suitable for continuous flow water heaters
- MWELS 1 tick & 2 ticks

Code No. 14870000
14870800
14870000E
14870800E

Colour chrome
stainless steel optic



✓ Good
Water Consumption: 7.30 litres/min
Type of Product: Sink/Bib Taps and Mixers

Brand: Hansgrohe
Model: Talis S Variarc Kitchen Mixer 14870
Reg no.: SKT/BT-2009/002929



✓✓ Very Good
Water Consumption: 4.60 litres/min
Type of Product: Sink/Bib Taps and Mixers

Brand: Hansgrohe
Model: Talis S² Variarc Kitchen Mixer 14870E
Reg no.: SKT/BT-2013/012228

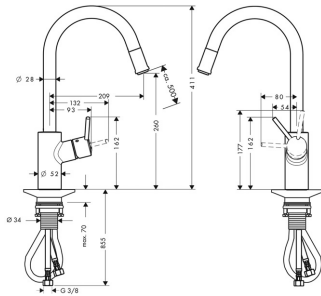

Single Lever Kitchen Mixer with pull-out spray

- swivel range 150°
- installation in front of the window, can be laid flat, base height 70mm
- vertical handle position
- normal spray
- MagFit magnetic shower support
- quick connect shower hose
- connection dimension: DN15
- ceramic cartridge
- G^{3/8} connections
- integrated non-return valve
- suitable for continuous flow water heaters
- MWELS 1 tick & 2 ticks

Code No. 14872000
14872800
14872000E
14872800E

Colour chrome
stainless steel optic



✓ Good
Water Consumption: 7.20 litres/min
Type of Product: Sink/Bib Taps and Mixers

Brand: Hansgrohe
Model: Talis S Variarc Kitchen Mixer Pull Out 14872
Reg no.: SKT/BT-2010/004538



✓✓ Very Good
Water Consumption: 4.40 litres/min
Type of Product: Sink/Bib Taps and Mixers

Brand: Hansgrohe
Model: Variarc Kitchen Mixer With Pull Out Spout 14872E
Reg no.: SKT/BT-2009/002930

Talis S² Variarc

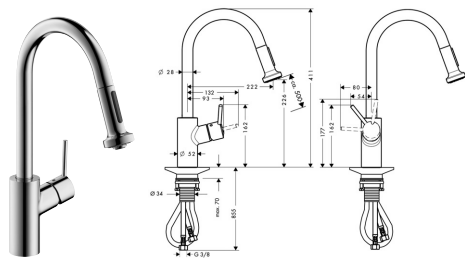

Single Lever Kitchen Mixer DN15 with pull-out spray

- QuickClean anti-limescale system
- ceramic cartridge
- Bolitic lever lock
- swivel spout 150°
- Normal and spray jet (non-arresting)
- suitable for mounting in front of a window, can be laid flat
- non-return valve, magnetic shower support
- MWELS 1 tick & 2 ticks

Code No. 14877000
14877000E
Colour chrome



✓ **Good**
Water Consumption: 6.70 litres/min
Type of Product: Sink/Bib Taps and Mixers
Brand: Hansgrohe
Model: Variarc Kitchen Mixer With Pull Out/Spray 14877
Reg no.: SKT/BT-2009/003752



✓✓ **Very Good**
Water Consumption: 4.30 litres/min
Type of Product: Sink/Bib Taps and Mixers
Brand: Hansgrohe
Model: Variarc Kitchen Mixer With Pull Out / Spray 14877E
Reg no.: SKT/BT-2009/002931

Focus

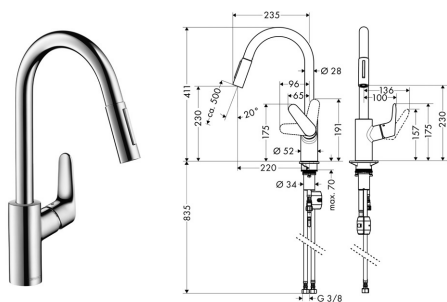

Single Lever Kitchen Mixer with pull-out spray

- swivel spout 150°
- vertical handle position
- laminar spray and shower spray
- lockable shower spray, spray returns through pressing spray diverter
- MagFit magnetic shower support
- quick connect shower hose
- connection dimension: DN15
- ceramic cartridge
- G 3/8 connections
- integrated non-return valve
- suitable for continuous flow water heaters
- MWELS 1 tick, 2 ticks & 3 ticks

Code No. 31815000
31815000E
31815000L

Colour chrome
stainless steel optic



✓ **Good**
Water Consumption: 7.40 litres/min
Type of Product: Sink/Bib Taps and Mixers
Brand: Hansgrohe
Model: Focus 31815
Reg no.: SKT/BT-2014/014523



✓✓ **Very Good**
Water Consumption: 4.70 litres/min
Type of Product: Sink/Bib Taps and Mixers
Brand: Hansgrohe
Model: Focus 31815E
Reg no.: SKT/BT-2014/014524



✓✓✓ **Excellent**
Water Consumption: 1.70 litres/min
Type of Product: Basin Taps and Mixers
Brand: Hansgrohe
Model: Metris 31085L
Reg no.: BST-2014/014602

Focus

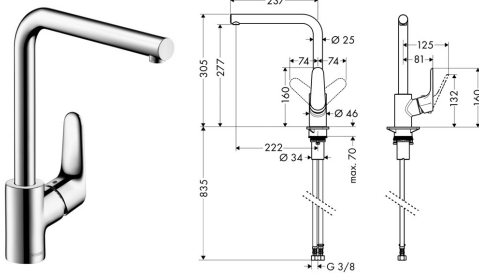

Single Lever Kitchen Mixer with swivel spout

- I-spout
- swivel range adjustable in 3 steps 110°, 150° or 360°
- handle can be positioned on the right or left
- laminar spray
- connection dimension: DN15
- ceramic cartridge
- G 3/8 connections
- suitable for continuous flow water heaters
- MWELS 1 tick, 2 ticks & 3 ticks

Code No. 31817000
31817800
31817000E
31817800E
31817000L
31817800L

Colour chrome
stainless steel optic



✓ **Good**
Water Consumption: 7.70 litres/min
Type of Product: Sink/Bib Taps and Mixers
Brand: Hansgrohe
Model: 31817
Reg no.: SKT/BT-2014/014279



✓✓ **Very Good**
Water Consumption: 5.20 litres/min
Type of Product: Sink/Bib Taps and Mixers
Brand: Hansgrohe
Model: 31817E
Reg no.: SKT/BT-2014/014280



✓✓✓ **Excellent**
Water Consumption: 3.60 litres/min
Type of Product: Sink/Bib Taps and Mixers
Brand: Hansgrohe
Model: 31817L
Reg no.: SKT/BT-2014/014299

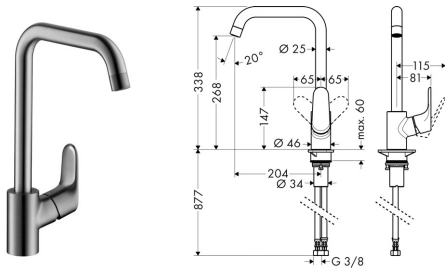

Single Lever Kitchen Mixer, DN15

- handle position on right or left side possible
- QuickClean anti-limescale system
- ceramic cartridge
- Boltic lever lock
- swivel spout (adjustable in 3 steps 110°, 150° or 360°)
- connecting hoses G 3/8
- MWELS 1 tick & 2 ticks

Code No. 31820000
31820800
31820000E
31820800E

Colour chrome
stainless steel optic



✓ **Good**
Water Consumption: 7.90 litres/min
Type of Product: Sink/Bib Taps and Mixers
Brand: Hansgrohe
Model: Focus Single Lever Kitchen Mixer 31820
Reg no.: SKT/BT-2013/012187



✓✓ **Very Good**
Water Consumption: 4.40 litres/min
Type of Product: Sink/Bib Taps and Mixers
Brand: Hansgrohe
Model: Focus Single Lever Kitchen Mixer 31820E
Reg no.: SKT/BT-2013/012188

Focus E

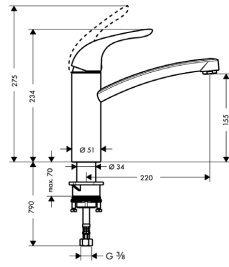

Single Lever Kitchen Mixer DN15 with 1/2" connections

- QuickClean system
- ceramic cartridge, Boltic lever lock
- swivel spout 360°
- MWELS 1 tick & 2 ticks

Code No. 31780000
31780000E
Colour chrome



✓ **Good**
Water Consumption: 7.10 litres/min
Type of Product: Sink/Bib Taps and Mixers
Brand: Hansgrohe
Model: Focus E Single Lever Kitchen Mixer 31780
Reg no.: SKT/BT-2009/003751



✓✓ **Very Good**
Water Consumption: 4.50 litres/min
Type of Product: Sink/Bib Taps and Mixers
Brand: Hansgrohe
Model: Focus E Kitchen Mixer 31780E
Reg no.: SKT/BT-2009/002933

Focus E²

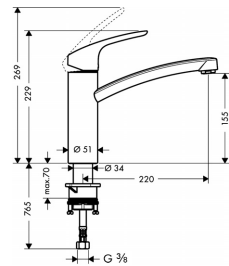

Single Lever Kitchen Mixer DN15 with 1/2" connections

- QuickClean system
- ceramic cartridge, Boltic lever lock
- swivel spout 360°
- MWELS 1 tick, 2 ticks & 3 ticks

Code No. 31806000
31806000E
31806000L
Colour chrome



✓ **Good**
Water Consumption: 7.30 litres/min
Type of Product: Sink/Bib Taps and Mixers
Brand: Hansgrohe
Model: 31806
Reg no.: SKT/BT-2015/017307



✓✓ **Very Good**
Water Consumption: 4.80 litres/min
Type of Product: Sink/Bib Taps and Mixers
Brand: Hansgrohe
Model: Focus E2 Single Lever Kitchen Mixer 31806
Reg no.: SKT/BT-2010/005035



✓✓✓ **Excellent**
Water Consumption: 3.20 litres/min
Type of Product: Sink/Bib Taps and Mixers
Brand: Hansgrohe
Model: Focus E2 Single Lever Kitchen Mixer 31806L
Reg no.: SKT/BT-2011/008155

Focus S

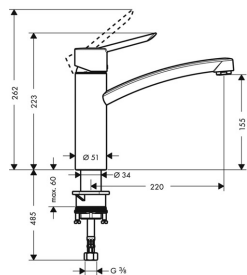

Single Lever Kitchen Mixer DN15 with 1/2" connections

- QuickClean system
- ceramic cartridge, Boltic lever lock
- swivel spout 360°
- MWELS 1 tick & 2 ticks

Code No. 31786000
31786000E
Colour chrome



✓ **Good**
Water Consumption: 6.90 litres/min
Type of Product: Sink/Bib Taps and Mixers
Brand: Hansgrohe
Model: Focus S Single Lever Kitchen Mixer 31786
Reg no.: SKT/BT-2009/003750



✓✓ **Very Good**
Water Consumption: 4.50 litres/min
Type of Product: Sink/Bib Taps and Mixers
Brand: Hansgrohe
Model: Focus S Kitchen Mixer 31786E
Reg no.: SKT/BT-2009/002932

Axor Starck

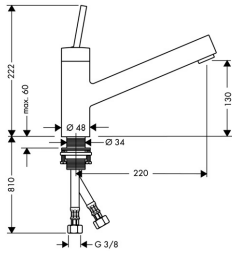

Single Lever Kitchen Mixer

- swivel spout 360°
- normal spray
- connection dimension: DN15
- joystick ceramic cartridge
- G 3/8 connections
- integrated non-return valve
- suitable for continuous flow water heaters
- MWELS 1 tick

Code No. 10801000

Colour chrome



✓ Good

Water Consumption: 7.70 litres/min

Type of Product: Sink/Bib Taps and Mixers

Brand: Axor

Model: Starck Kitchen Mixer Puro Handle 10801

Reg no.: SKT/BT-2011/006942

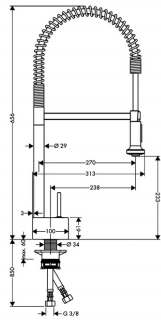

Single Lever Kitchen Mixer Semi-Pro

- swivel spout 360°, normal and spray jet
- lockable shower spray, spray returns through pressing spray diverter
- connection dimension: DN15
- joystick ceramic cartridge
- G 3/8 connections
- integrated non-return valve
- suitable for continuous flow water heaters
- MWELS 2 ticks

Code No. 10820000E

Colour chrome



✓✓ Very Good

Water Consumption: 4.40 litres/min

Type of Product: Sink/Bib Taps and Mixers

Brand: Axor

Model: Starck Semi Pro Kitchen Mixer 10820E

Reg no.: SKT/BT-2010/004875

Axor Starck

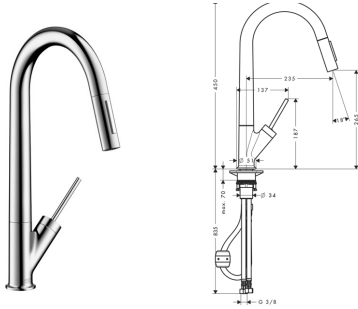

Single Lever Kitchen Mixer with pull-out spray

- swivel range 110° / 150°
- handle can be positioned on the right or left
- normal and spray jet
- lockable shower spray, spray returns through pressing spray diverter
- MagFit magnetic shower support
- quick connect shower hose
- connection dimension: DN15
- joystick ceramic cartridge
- connection type: G 3/8 connections
- integrated non-return valve
- suitable for continuous flow water heaters
- MWELS 1 tick & 2 ticks

Code No. 10821000
 10821000E
 10821800
 10821800E
Colour chrome



✓ Good
 Water Consumption: 6.20 litres/min
 Type of Product: Sink/Bib Taps and Mixers
 Brand: Axor
 Model: 10821
 Reg no.: SKT/BT-2014/015904



✓✓ Very Good
 Water Consumption: 4.70 litres/min
 Type of Product: Sink/Bib Taps and Mixers
 Brand: Axor
 Model: 10821E
 Reg no.: SKT/BT-2014/015905

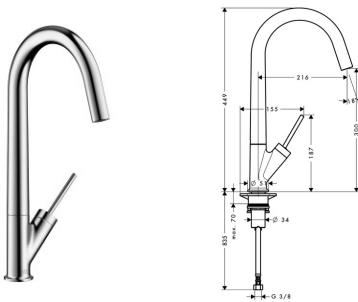

Single Lever Kitchen Mixer

- swivel range adjustable in 3 steps 110°, 150° or 360°
- handle can be positioned on the right or left
- normal spray
- connection dimension: DN15
- joystick ceramic cartridge
- G 3/8 connections
- integrated non-return valve
- suitable for continuous flow water heaters
- MWELS 1 tick & 2 ticks

Code No. 10822000
 10822000E
Colour chrome



✓ Good
 Water Consumption: 7.90 litres/min
 Type of Product: Sink/Bib Taps and Mixers
 Brand: Axor
 Model: 10822
 Reg no.: SKT/BT-2014/015908



✓✓ Very Good
 Water Consumption: 4.60 litres/min
 Type of Product: Sink/Bib Taps and Mixers
 Brand: Axor
 Model: 10822E
 Reg no.: SKT/BT-2014/015069

Axor Citterio M

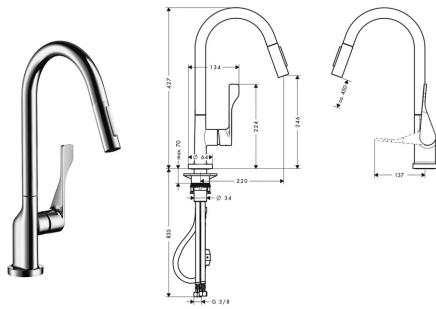

Single Lever Kitchen Mixer with pull-out spray

- swivel spout 360° / 150°
- normal and spray jet
- lockable shower spray, spray returns through pressing spray diverter
- MagFit magnetic shower support
- quick connect shower hose
- connection dimension: DN15
- ceramic cartridge
- G 3/8 connections
- integrated non-return valve
- suitable for continuous flow water heaters
- MWELS 1 tick & 2 ticks

Code No. 39835000
 39835000E
 39835000L
 39835800
 39835800E
 39835800L

Colour chrome
 stainless steel optic



✓ Good
 Water Consumption: 7.70 litres/min
 Type of Product: Sink/Bib Taps and Mixers
 Brand: Axor
 Model: 39835
 Reg no.: SKT/BT-2013/014054



✓✓ Very Good
 Water Consumption: 5.10 litres/min
 Type of Product: Sink/Bib Taps and Mixers
 Brand: Axor
 Model: 39835E
 Reg no.: SKT/BT-2013/014055



✓✓✓ Excellent
 Water Consumption: 3.90 litres/min
 Type of Product: Sink/Bib Taps and Mixers
 Brand: Axor
 Model: 39835L
 Reg no.: SKT/BT-2014/015915

Axor Uno²

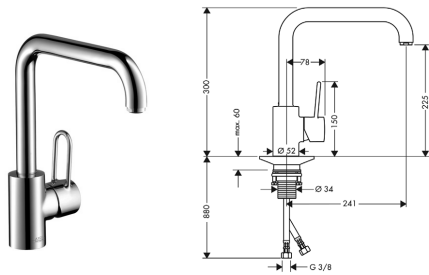

Single Lever Kitchen Mixer DN15

- swivel spout 360°
- variable positioning of handle: right, left or front
- ceramic cartridge
- QuickClean aerator
- for continuous flow water heaters
- MWELS 1 tick & 2 ticks

Code No. 14850000
 14850000E

Colour chrome



✓ Good
 Water Consumption: 8.00 litres/min
 Type of Product: Sink/Bib Taps and Mixers
 Brand: Axor
 Model: Uno Kitchen Mixer 14850
 Reg no.: SKT/BT-2013/011736



✓✓ Good
 Water Consumption: 5.30 litres/min
 Type of Product: Sink/Bib Taps and Mixers
 Brand: Axor
 Model: Uno Kitchen Mixer 14850E
 Reg no.: SKT/BT-2013/011737

Axor Uno²

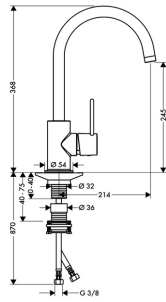

Single Lever Kitchen Mixer DN15

- swivel spout 360°
- ceramic cartridge
- suitable for continuous flow water heaters
- MWELS 3 ticks

Code No. 38830000L
 38830800L
Colour chrome
 stainless steel optic



✓✓✓ Excellent
 Water Consumption: 3.60 litres/min
 Type of Product: Sink/Bib Taps and Mixers
 Brand: Axor
 Model: Uno 2 Single Lever Kitchen Mixer 38830L
 Reg no.: SKT/BT-2010/004518

Axor Steel

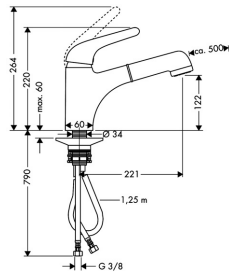

Single Lever Kitchen Mixer with pullout spray DN15

- Normal and soft spray
- swivel spout 130°
- ceramic cartridge
- QuickClean aerator
- non-return valve
- suitable for continuous flow water heaters
- MWELS 2 ticks

Code No. 35807800E
Colour steel



✓✓ Very Good
 Water Consumption: 4.44 litres/min
 Type of Product: Sink/Bib Taps and Mixers
 Brand: Axor
 Model: Allegra Steel Kitchen Mixer 35807800E
 Reg no.: SKT/BT-2009/002910

VWELS compliant Showers

The following products are showers that are also available in VWELS compliant versions. They are installed with a limiter to ensure that the flow rates do not exceed 9 litres/min. The list is accurate at the time of print. Please enquire for the latest current VWELS compliant product list.

hansgrohe

Hansgrohe VWELS Approved Products

Type	Article No.	Descriptions	1 tick	2 ticks	3 ticks	Water Consumption
Overhead Shower	26443	Raindance Rainfall 150 Stream	✓			8.20 litres/min
Overhead Shower	26464	Croma 220 Air 1Jet Overhead shower	✓			7.60 litres/min
Overhead Shower	26464E	Croma 220 Air 1Jet Overhead Shower		✓✓		6.20 litres/min
Overhead Shower	26481	Raindance 260 x 260 Air 1Jet Overhead Shower	✓			7.10 litres/min
Hand Shower	26520	Raindance Select E120 Hand Shower	✓			7.70 litres/min
Hand Shower	26520E	Raindance Select E120 Hand Shower		✓✓		6.50 litres/min
Overhead Shower	26524	Croma Select E180 Overhead Shower	✓			7.30 litres/min
Overhead Shower	26524E	Croma Select E180 Overhead Shower		✓✓		5.30 litres/min
Hand Shower	26530	Raindance Select S120 Hand shower	✓			7.50 litres/min
Hand Shower	26530E	Raindance Select S120 Hand Shower		✓✓		6.20 litres/min
Hand Shower	26550	Raindance Select E150 Hand Shower	✓			7.80 litres/min
Hand Shower	26550E	Raindance Select E150 Hand Shower		✓✓		6.50 litres/min
Overhead Shower	27370	Raindance E240 Air 1Jet Overhead Shower	✓			8.40 litres/min
Overhead Shower	27370E	Raindance E240 Air 1Jet Overhead Shower		✓✓		7.00 litres/min
Overhead Shower	27371	Raindance E360 1Jet Overhead Shower	✓			8.60 litres/min
Overhead Shower	27380	Raindance E240 Air 1Jet Overhead Shower	✓			8.60 litres/min
Overhead Shower	27380E	Raindance E240 Air 1Jet Overhead Shower		✓✓		6.90 litres/min
Overhead Shower	27381	Raindance E240 Air 1Jet Overhead Shower	✓			8.50 litres/min
Overhead Shower	27384	Raindance Select E300 2Jet Overhead Shower	✓			7.20 litres/min
Overhead Shower	27384E	Raindance Select E300 2Jet Overhead Shower		✓✓		7.00 litres/min
Overhead Shower	27404001	Raindance Square Overhead Shower 180	✓			8.20 litres/min
Overhead Shower	27404001E	Raindance Square Overhead Shower 180		✓✓		7.00 litres/min
Overhead Shower	27405	Raindance Classic 240 Air 1Jet Overhead Shower	✓			8.70 litres/min
Overhead Shower	27406	Raindance Classic 300 Air 1Jet Overhead Shower	✓			8.50 litres/min
Overhead Shower	27441	Croma 100 Vario Overhead Shower	✓			7.50 litres/min
Overhead Shower	27443	Croma 100 Multi Overhead Shower	✓			8.40 litres/min
Overhead Shower	27443E	Croma 100 Multi Overhead Shower		✓✓		7.00 litres/min
Overhead Shower	27450	Croma 160 Overhead Shower	✓			7.10 litres/min
Overhead Shower	27450E	Croma 160 Overhead Shower		✓✓		5.30 litres/min
Overhead Shower	27462E	Raindance Air Overhead Shower 180 EcoSmart Version		✓✓		6.50 litres/min
Overhead Shower	27463	Raindance S240 Air 1Jet Overhead Shower	✓			8.40 litres/min
Overhead Shower	27463E	Raindance S240 Air 1Jet Overhead Shower		✓✓		6.30 litres/min
Overhead Shower	27468	Raindance S180 Air 1Jet Overhead Shower	✓			8.40 litres/min
Overhead Shower	27468E	Raindance S180 Air 1Jet Overhead Shower		✓✓		6.90 litres/min
Overhead Shower	27471E	Raindance S180 Air 1Jet Overhead Shower		✓✓		6.70 litres/min
Overhead Shower	27472	Raindance S180 Air 1Jet Overhead Shower	✓			7.00 litres/min
Overhead Shower	27472E	Raindance S180 Air 1Jet Overhead Shower		✓✓		7.00 litres/min
Overhead Shower	27474	Raindance S240 Air 1Jet Overhead Shower	✓			8.80 litres/min
Overhead Shower	27474E	Raindance S240 Air 1Jet Overhead Shower		✓✓		6.80 litres/min
Overhead Shower	27477	Raindance S240 Air 1Jet Overhead Shower	✓			7.30 litres/min
Overhead Shower	27477E	Raindance S240 Air 1Jet Overhead Shower		✓✓		6.20 litres/min
Overhead Shower	27478	Raindance S180 Air 1Jet Overhead Shower	✓			7.10 litres/min
Overhead Shower	27492	Raindance S300 Air 1Jet Overhead Shower	✓			8.50 litres/min
Overhead Shower	27494	Raindance S300 Air 1Jet Overhead Shower	✓			8.00 litres/min
Overhead Shower	27494E	Raindance S300 Air 1Jet Overhead Shower		✓✓		6.60 litres/min
Hand Shower	27803	Raindance Select S150 Wall Bar Set	✓			8.50 litres/min
Overhead Shower	28424	Crometta 85 Vario Overhead Shower	✓			8.50 litres/min

Hansgrohe VWELS Approved Products

Type	Article No.	Descriptions	1 tick	2 ticks	3 ticks	Water Consumption
Overhead Shower	28425	Crometta 85 Multi Overhead Shower	✓			8.50 litres/min
Overhead Shower	28433	Raindance Rainfall 180 Air 2Jet	✓			8.50 litres/min
Overhead Shower	28471	Raindance Classic 150 Air 3 jet Overhead Shower	✓			8.80 litres/min
Hand Shower	28502E	Raindance E100 Air 3Jet Hand Shower		✓✓		6.80 litres/min
Hand Shower	28504	Raindance S100 Air 3Jet Hand Shower	✓			8.70 litres/min
Hand Shower	28504E	Raindance S100 Air 3Jet Hand Shower		✓✓		6.90 litres/min
Hand Shower	28505E	Raindance S150 Air 1Jet Hand Shower		✓✓		6.70 litres/min
Hand Shower	28507E	Raindance E120 Air 3Jet Hand Shower		✓✓		6.70 litres/min
Hand Shower	28508	Raindance E100 Air 1Jet Hand Shower	✓			8.70 litres/min
Hand Shower	28508E	Raindance E100 Air 1Jet Hand Shower		✓✓		6.80 litres/min
Hand Shower	28509	Raindance S100 Air 1Jet Hand Shower	✓			8.70 litres/min
Hand Shower	28509E	Raindance S100 Air 1Jet Hand Shower		✓✓		6.70 litres/min
Hand Shower	28514	Raindance S120 Air 3jet Hand Shower	✓			8.40 litres/min
Hand Shower	28514E	Raindance S120 Air 3jet Hand Shower		✓✓		6.80 litres/min
Hand Shower	28518	Raindance E150 3Jet Hand Shower	✓			7.50 litres/min
Hand Shower	28535	Croma 100 Vario Hand Shower	✓			7.50 litres/min
Hand Shower	28536	Croma 100 Multi Hand Shower	✓			8.30 litres/min
Hand Shower	28539	Croma 100 Classic Hand Shower	✓			8.10 litres/min
Hand Shower	28539E	Croma 100 Classic Hand Shower		✓✓		7.00 litres/min
Hand Shower	28548	Raindance Classic 100 Air 3jet Hand Shower	✓			7.50 litres/min
Hand Shower	28557	PuraVida 150 3Jet Hand Shower	✓			7.10 litres/min
Hand Shower	28558	PuraVida 120 1Jet Hand Shower	✓			7.00 litres/min
Hand Shower	28558E	PuraVida 120 1Jet Hand Shower		✓✓		7.00 litres/min
Hand Shower	28562	Crometta 85 Vario Hand Shower	✓			8.50 litres/min
Hand Shower	28562E	Crometta 85 Vario Hand Shower		✓✓		6.90 litres/min
Hand Shower	28563	Crometta 85 Multi Hand Shower	✓			7.30 litres/min
Hand Shower	28563E	Crometta 85 Multi Hand Shower		✓✓		6.90 litres/min
Hand Shower	28585	Crometta 85 Mono Hand Shower	✓			7.60 litres/min
Hand Shower	28585E	Crometta 85 Mono Hand Shower		✓✓		6.50 litres/min
Hand Shower	28587	Raindance Select S150 Hand Shower	✓			8.50 litres/min

Axor VWELS Approved Products

Type	Article No.	Descriptions	1 tick	2 ticks	3 ticks	Water Consumption
Hand Shower	10531	Axor Starck Baton Hand Shower	✓			8.20 litres/min
Hand Shower	10531E	Axor Starck Baton Hand Shower		✓✓		7.00 litres/min
Overhead Shower	10924	Axor Starck Organic 240mm x 240mm 1Jet Overhead Shower	✓			8.80 litres/min
Overhead Shower	10929	Axor Starck Organic 240mm x 240mm 1Jet Overhead Shower with ceiling connector	✓			8.00 litres/min
Overhead Shower	20625	Axor Hand Shower by Front	✓			8.30 litres/min
Overhead Shower	20625E	Axor Hand Shower by Front		✓✓		7.00 litres/min
Overhead Shower	26031	Axor LampShower by Nendo wall-mounted	✓			8.80 litres/min
Overhead Shower	26032	Axor LampShower by Nendo ceiling-mounted	✓			8.20 litres/min
Overhead Shower	28484	Axor Massaud Overhead Shower 1Jet 180	✓			7.50 litres/min
Overhead Shower	28484E	Axor Massaud Overhead Shower 1Jet 180		✓✓		6.20 litres/min
Overhead Shower	28489	Axor Citterio Overhead Shower 1Jet 180	✓			7.80 litres/min
Overhead Shower	28489E	Axor Citterio Overhead Shower 1Jet 180		✓✓		6.50 litres/min
Overhead Shower	28494	Axor Starck Overhead shower 1Jet 240	✓			7.40 litres/min

Axor VWELS Approved Products

Type	Article No.	Descriptions	1 tick	2 ticks	3 ticks	Water Consumption
Overhead Shower	28494E	Axor Starck Overhead Shower 1Jet 240		✓✓		6.60 litres/min
Hand Shower	28532	Axor Starck 2Jet Baton Hand Shower	✓			7.10 litres/min
Hand Shower	28532E	Axor Starck 2Jet Baton Hand Shower		✓✓		5.60 litres/min
Overhead Shower	34610	Axor Citterio M Overhead Shower	✓			8.00 litres/min
Overhead Shower	34610E	Axor Citterio M Overhead Shower		✓✓		6.90 litres/min
Shower	39740	Axor Citterio Overhead Shower	✓			8.00 litres/min

Hand Shower

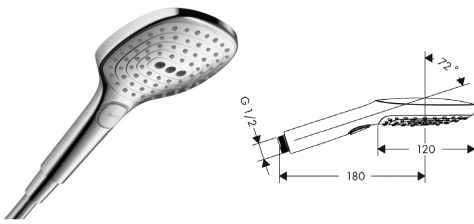

Raindance Select E 120 3jet Hand Shower

- shower head size: 120mm
- convenient diversion via Select button
- spray type: RainAir, Rain, massage spray
- with internal water conduction
- rinseable dirt filter
- connecting thread G 1/2
- connection dimension: DN15
- suitable for continuous flow water heaters
- VWELS 1 tick & 2 ticks

Code No. 26520000
26520000E
Colour chrome
white chrome



✓ Good
Water Consumption: 7.70 litres/min
Type of Product: Showerheads
Brand: Hansgrohe
Model: Raindance Select E120
Hand Shower 26520
Reg no.: 02/2013/117606



✓✓ Very Good
Water Consumption: 6.50 litres/min
Type of Product: Showerheads
Brand: Hansgrohe
Model: Raindance Select E120
Hand Shower 26520E
Reg no.: 02/2013/117607

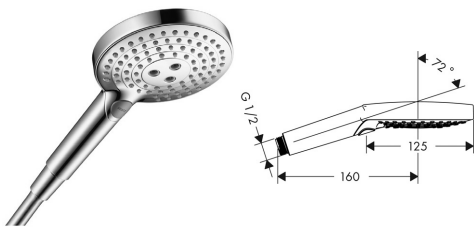

Raindance Select S 120 3jet Hand Shower

- shower head size: 125mm
- convenient diversion via Select button
- spray type: Rain, RainAir, WhirlAir
- with internal water conduction
- rinseable dirt filter
- connecting thread G 1/2
- connection dimension: DN15
- suitable for continuous flow water heaters
- VWELS 1 tick & 2 ticks

Code No. 26530000
26530000E
Colour chrome
white chrome



✓ Good
Water Consumption: 7.50 litres/min
Type of Product: Showerheads
Brand: Hansgrohe
Model: 26530
Reg no.: 02/2013/118410



✓✓ Very Good
Water Consumption: 6.20 litres/min
Type of Product: Showerheads
Brand: Hansgrohe
Model: 26530E
Reg no.: 02/2013/118411

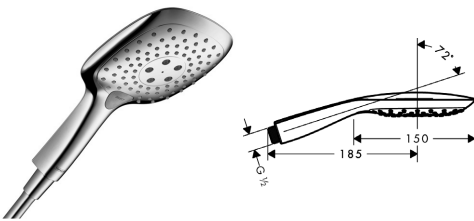

Raindance Select E 150 3jet Hand Shower

- hand shower with 2-shell construction
- shower head size: 150mm
- convenient diversion via Select button
- spray type: RainAir, CaresseAir, Mix
- with internal water conduction
- rinseable dirt filter
- connecting thread G 1/2
- connection dimension: DN15
- suitable for continuous flow water heaters
- VWELS 1 tick & 2 ticks

Code No. 26550000
26550000E
Colour chrome



✓ Good
Water Consumption: 7.80 litres/min
Type of Product: Showerheads
Brand: Hansgrohe
Model: Raindance Select E150
Hand Shower 26550
Reg no.: 02/2013/117608



✓✓ Very Good
Water Consumption: 6.50 litres/min
Type of Product: Showerheads
Brand: Hansgrohe
Model: Raindance Select E150
Hand Shower 26550E
Reg no.: 02/2013/117609

Hand Shower

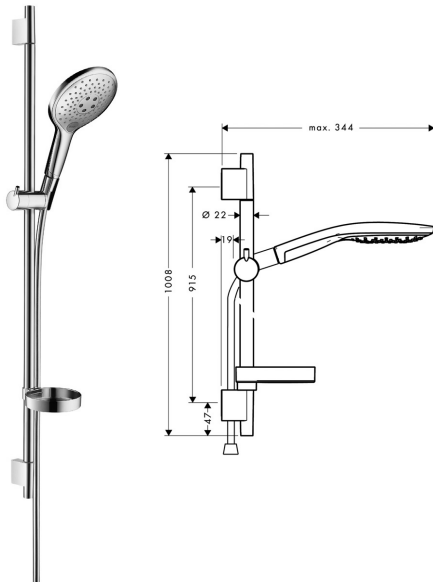

Raindance Select S 150 3jet Hand Shower / Unica'S Puro Wall Bar 0.90m set

- wall bar spacer (grey)
- Isiflex shower hose 1.60m (no.28276XXX)
- Raindance Select S 150 3jet hand shower (no.28587XXX)
- Unica'S Puro wall bar 0.90m (no.28631XXX)
- Casetta'S Puro soap dish (no.28679000)
- VWELS 1 tick

Code No. 27803000
27803400
Colour chrome
white chrome



✓ Good
Water Consumption: 8.50 litres/min
Type of Product: Showerheads
Brand: Hansgrohe
Model: 27803000
Reg no.: 02/2014/119770

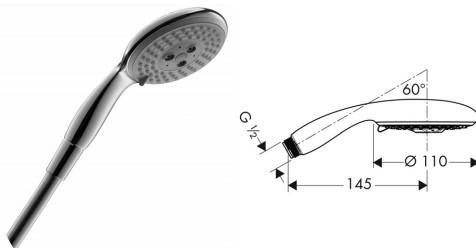

Raindance E 100 Air 3jet Hand Shower

- shower head size: 110mm
- spray type adjustment by turning spray disc
- spray type: RainAir, WhirlAir, BalanceAir
- rinseable dirt filter
- connecting thread G 1/2
- connection dimension: DN15
- suitable for continuous flow water heaters
- VWELS 2 ticks

Code No. 28502000E
Colour chrome



✓✓ Very Good
Water Consumption: 6.80 litres/min
Type of Product: Showerheads
Brand: Hansgrohe
Model: Raindance E100 Air 3 Jet Hand Shower 28502E
Reg no.: 02/2012/114621

Hand Shower

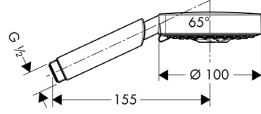

Raindance S 100 Air 3jet Hand Shower DN15

- extra large shower head Ø 100mm
- choice of 3 spray modes: Rain Air, Whirl Air, Balance Air, AirPower technology
- rinseable dirt filter, QuickClean system
- suitable for continuous flow water heaters from 21KW upwards
- VWELS 1 tick & 2 ticks

Code No. 28504000
28504000E
Colour chrome



✓ Good
Water Consumption: 8.70 litres/min
Type of Product: Showerheads
Brand: Hansgrohe
Model: 28504000
Reg no.: 02/2014/119773



✓✓ Very Good
Water Consumption: 6.90 litres/min
Type of Product: Showerheads
Brand: Hansgrohe
Model: Raindance S100 Air 3 Jet Hand Shower 28504E
Reg no.: 02/2012/114622

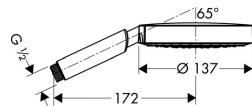

Raindance S 150 Air 1jet Hand Shower DN15

- extra large shower head Ø 137mm
- extra wide shower rain: Rain Air, AirPower technology
- rinseable dirt filter, QuickClean system
- suitable for continuous flow water heaters from 21KW upwards
- VWELS 2 ticks

Code No. 28505000E
Colour chrome



✓✓ Very Good
Water Consumption: 6.70 litres/min
Type of Product: Showerheads
Brand: Hansgrohe
Model: Raindance S150 Air 1 Jet Hand Shower 28505E
Reg no.: 02/2012/114623

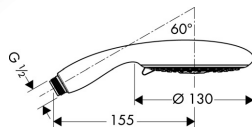

Raindance E 120 Air 3jet Hand Shower DN15

- extra large shower head Ø 130mm
- choice of 3 spray modes: Rain Air, Whirl Air, Balance Air, AirPower technology
- rinseable dirt filter, QuickClean system
- suitable for continuous flow water heaters from 21KW upwards
- VWELS 2 ticks

Code No. 28507000E
Colour chrome



✓✓ Very Good
Water Consumption: 6.70 litres/min
Type of Product: Showerheads
Brand: Hansgrohe
Model: Raindance E120 Air 3 Jet 28507E
Reg no.: 02/2012/114624

Hand Shower

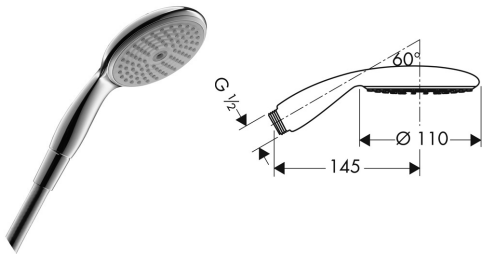

Raindance E 100 Air 1jet Hand Shower

- shower head size: 110 mm
- spray type: RainAir
- rinseable dirt filter
- connection thread G 1/2
- connection dimension: DN15
- suitable for continuous flow water heaters
- VWELS 1 tick & 2 ticks

Code No. 28508000
28508000E
Colour chrome



✓ Good
Water Consumption: 8.70 litres/min
Type of Product: Showerheads
Brand: Hansgrohe
Model: Raindance E 28508000
Serial no.: 02/2014/119647



✓✓ Very Good
Water Consumption: 6.80 litres/min
Type of Product: Showerheads
Brand: Hansgrohe
Model: Raindance E 28508E
Serial no.: 02/2014/119648

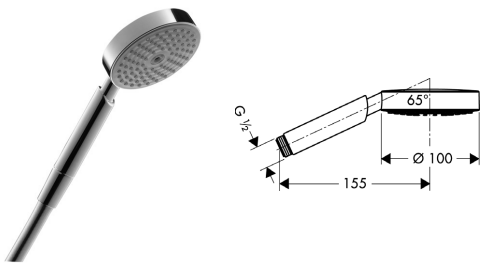

Raindance S 100 Air 1jet Hand Shower

- shower head size: 110 mm
- spray type: RainAir
- rinseable dirt filter
- connection thread G 1/2
- connection dimension: DN15
- suitable for continuous flow water heaters
- VWELS 1 tick & 2 ticks

Code No. 28509000
28509000E
Colour chrome



✓ Good
Water Consumption: 8.70 litres/min
Type of Product: Showerheads
Brand: Hansgrohe
Model: Raindance S 28509000
Serial no.: 02/2014/119649



✓✓ Very Good
Water Consumption: 6.70 litres/min
Type of Product: Showerheads
Brand: Hansgrohe
Model: Raindance S100 Air 1 Jet Hand Shower 28509E
Reg no.: 02/2012/114625

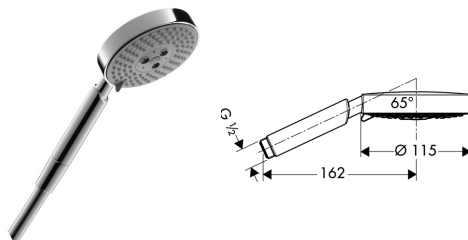

Raindance S 120 Air 3jet Hand Shower

- shower head size: 115mm
- spray type adjustment by turning spray disc
- spray type: RainAir, WhirlAir, BalanceAir
- rinseable dirt filter
- connecting thread G 1/2
- connection dimension: DN15
- suitable for continuous flow water heaters
- VWELS 1 tick & 2 ticks

Code No. 28514000
28514000E
Colour chrome



✓ Good
Water Consumption: 8.40 litres/min
Type of Product: Showerheads
Brand: Hansgrohe
Model: Raindance S 28514000
Reg no.: 02/2014/119650



✓✓ Very Good
Water Consumption: 6.80 litres/min
Type of Product: Showerheads
Brand: Hansgrohe
Model: Raindance S120 Air 3 Jet Hand Shower 28514E
Reg no.: 02/2012/114627

Hand Shower

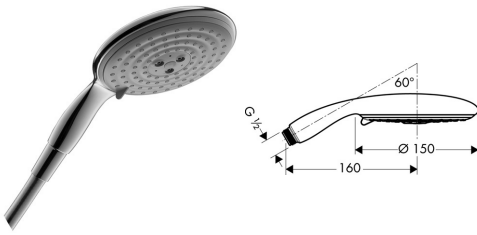

Raindance E 150 Air 3jet Hand Shower

- shower head size: 150mm
- spray type adjustment by turning spray disc
- spray type: RainAir, WhirlAir, BalanceAir
- rinseable dirt filter
- connecting thread G 1/2
- connection dimension: DN15
- suitable for continuous flow water heaters
- VWELS 1 ticks

Code No. 28518000

Colour chrome



✓ Good

Water Consumption: 7.50 litres/min

Type of Product: Showerheads

Brand: Hansgrohe

Model: Raindance E150 3 jet Hand Shower 28518

Reg no.: 02/2013/117903

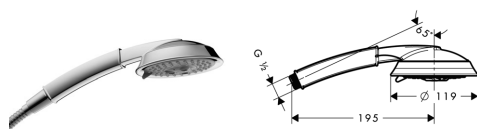

Raindance Classic 100 Air 3jet Hand Shower

- shower head size: 119 mm
- spray type adjustment by turning spray disc
- spray type: RainAir, WhirlAir, BalanceAir
- rinseable dirt filter
- connection thread G 1/2
- connection dimension: DN15
- suitable for continuous flow water heaters
- VWELS 1 tick

Code No. 28548000

Colour chrome



✓ Good

Water Consumption: 7.50 litres/min

Type of Product: Showerheads

Brand: Hansgrohe

Model: Raindance classic 100 air 3 jet handshower 28548

Serial No.: 02/2015/122919

Hand Shower

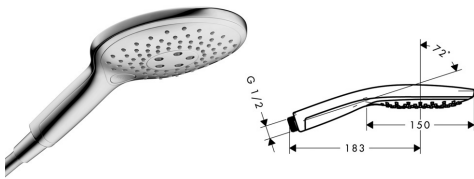

Raindance Select S 150 3jet Hand Shower

- hand shower with 2-shell construction
- shower head size: 150mm
- convenient diversion via Select button
- spray type: RainAir, CaresseAir, Mix
- with internal water conduction
- rinseable dirt filter
- connecting thread G 1/2
- connection dimensions: DN15
- suitable for continuous flow water heaters
- VWELS 1 tick

Code No. 28587000
28587400
Colour chrome
white chrome



✓ Good
Water Consumption: 8.50 litres/min
Type of Product: Showerheads
Brand: Hansgrohe
Model: Raindance Select 28587
Reg no.: 02/2014/121585

Overhead Shower

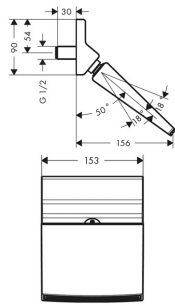

Raindance Rainfall Stream 150 1jet Overhead Shower

- shower head size: 150mm
- overhead shower angle adjustable
- spray type: Stream
- VWELS 1 tick

Code No. 26443000

Colour chrome



✓ Good

Water Consumption: 8.20 litres/min

Type of Product: Showerheads

Brand: Hansgrohe

Model: Raindance 26443000

Reg no.: 02/2014/119844

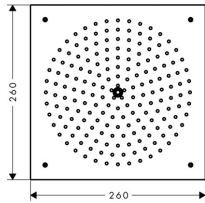
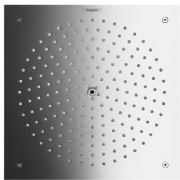

Raindance 260 x 260mm Air 1jet Overhead Shower

- shower head size: 240mm
- spray type: RainAir
- fully chrome-plated spray disc
- material spray disc: metal
- installation type: flush with the ceiling
- connecting thread G 1/2
- connection dimension: DN15
- spray disc removeable for cleaning
- VWELS 1 tick

Code No. 26481000

Colour chrome



✓ Good

Water Consumption: 7.10 litres/min

Type of Product: Showerheads

Brand: Hansgrohe

Model: 26481000

Reg no.: 02/2014/119761

Overhead Shower

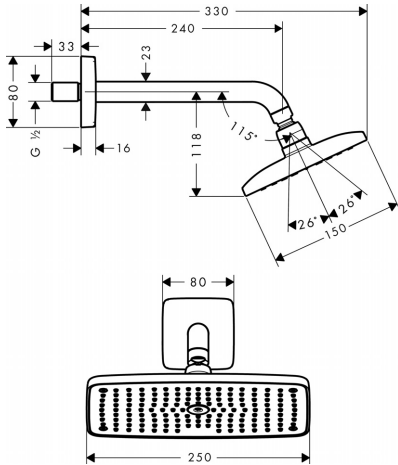

**Raindance E 240 Air 1jet
Overhead Shower
with Shower Arm 240mm**

- shower head size: 250 x 150mm
- shower arm length: 240mm
- overhead shower angle adjustable
- spray type: RainAir
- fully chrome-plated spray disc
- material spray disc: metal
- installation type: wall
- connecting thread G 1/2
- connection dimension: DN15
- spray disc removeable for cleaning
- VWELS 1 tick & 2 ticks

Code No. 27370000
27370000E
Colour chrome



✓ Good
Water Consumption: 8.40 litres/min
Type of Product: Showerheads
Brand: Hansgrohe
Model: 27370000
Reg no.: 02/2014/119764



✓✓ Very Good
Water Consumption: 7.00 litres/min
Type of Product: Showerheads
Brand: Hansgrohe
Model: Raindance E240 1Jet
Overhead Shower - 27370E
Reg no.: 02/2014/119354

Overhead Shower

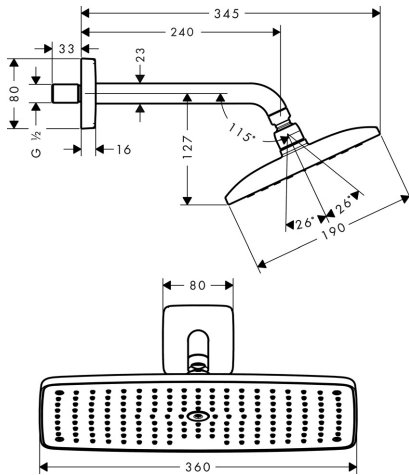

**Raindance E 360 Air 1jet
Overhead Shower
with Shower Arm 240mm**

- shower head size: 360 x 190mm
- shower arm length: 240 mm
- spray type: RainAir
- fully chrome-plated spray disc
- material spray disc: metal
- spray disc removeable for cleaning
- installation type: wall
- connecting thread G 1/2
- connection dimension: DN15
- VWELS 1 tick

Code No. 27371000

Colour chrome



✓ Good

Water Consumption: 8.60 litres/min

Type of Product: Showerheads

Brand: Hansgrohe

Model: Raindance E360 air 1 jet

overhead shower 27371

Serial No.: 02/2015/122920

Overhead Shower

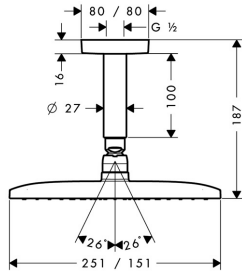

Raindance E 240 Air 1jet Overhead Shower DN15 with 100mm ceiling connector

- rectangular overhead shower 251x151 mm
- high-quality metal housing
- chrome spray disc
- extra-wide shower rain
- AirPower technology
- QuickClean anti-limescale system
- with ceiling connector plate
- swivel joint with security nut
- suitable for continuous flow water heaters, if the flow pressure at the mixer is a minimum of 0.15MPa
- VWELS 1 tick & 2 ticks

Code No. 27380000
27380000E
Colour chrome



✓ **Good**
Water Consumption: 8.60 litres/min
Type of Product: Showerheads
Brand: Hansgrohe
Model: Raindance 2738000
Reg no.: 02/2014/119642



✓✓ **Very Good**
Water Consumption: 6.90 litres/min
Type of Product: Showerheads
Brand: Hansgrohe
Model: Raindance 27380E
Reg no.: 02/2014/119643

Overhead Shower

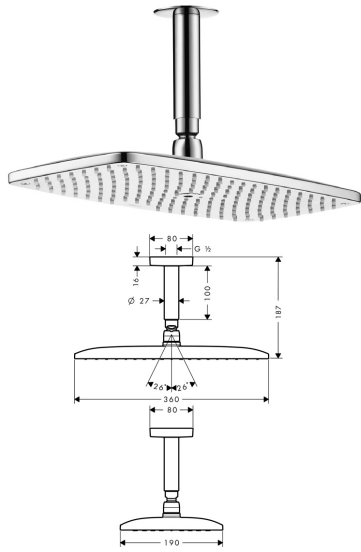

Code No. 27381000

Colour chrome

Raindance E 360 Air 1jet Overhead Shower with ceiling connector 100 mm

- shower head 360 x 190 mm
- spray type: RainAir
- fully chrome-plated spray disc
- material spray disc: metal
- spray disc removeable for cleaning
- ceiling connection length: 100 mm
- installation type: ceiling
- connection thread G 1/2
- connection dimension: DN15
- VWELS 1 tick



✓ Good

Water Consumption: 8.50 litres/min

Type of Product: Showerheads

Brand: Hansgrohe

Model: Raindance E 27381000

Serial no.: 02/2014/119644

Overhead Shower

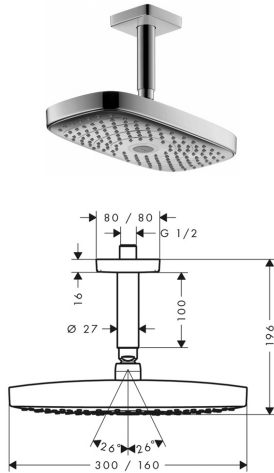

Raindance Select E 300 2jet Overhead Shower with ceiling connector, DN15

- rectangular overhead shower 300x160mm
- 2 spray modes:
 - Rain spray mode: powerful shower rain
 - RainAir spray mode: voluminous shower rain with AirPower technology
- Select button for comfortable alternation of spray modes
- centered air inlet jet, removable for cleaning
- spray disc cover out of metal, surface chrome or white, removable for better cleaning
- QuickClean anti-limescale system
- with ceiling connector plate and escutcheon
- swivel joint with security nut
- VVWELS 1 tick & 2 ticks

Code No. 27384000
27384000E
Colour chrome
white chrome



✓ Good
Water Consumption: 7.20 litres/min
Type of Product: Showerheads
Brand: Hansgrohe
Model: Raindance Select E300 2 Jet
Overhead Shower 27384
Reg no.: 02/2013/116458



✓✓ Very Good
Water Consumption: 7.00 litres/min
Type of Product: Showerheads
Brand: Hansgrohe
Model: Raindance Select E300 2Jet
Overhead Shower 27384E
Reg no.: 02/2013/116459

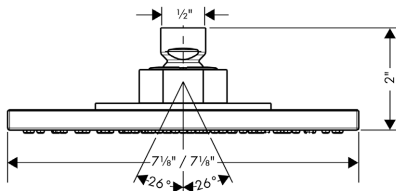
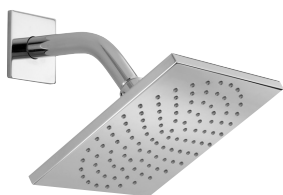

Raindance Overhead Shower Square 180mm chrome

- shower head size: 180mm
- installation type: ceiling or wall
- overhead shower angle adjustable
- spray type: Rain
- flow rate Rain spray (at 0.3 MPa): 2.5 GPM
- material spray disc: metal
- VVWELS 1 tick

Code No. 27404001
27404001E
Colour chrome



✓ Good
Water Consumption: 8.20 litres/min
Type of Product: Showerheads
Brand: Hansgrohe
Model: Square Overhead Shower 180 27404001
Reg no.: 02/2013/116462

Overhead Shower

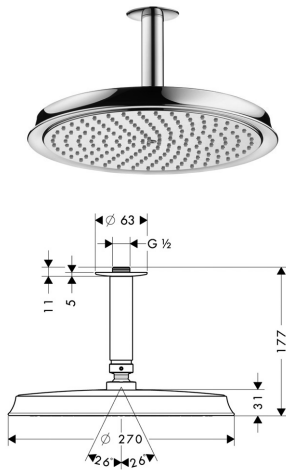

Raindance Classic 240 Air 1jet Overhead Shower with ceiling connector 100 mm

- shower head size: 240 mm
- spray type: RainAir
- fully chrome-plated spray disc
- material spray disc: metal
- ceiling connection length: 100 mm
- installation type: ceiling
- connection thread G 1/2
- connection dimension: DN15
- not suitable for continuous flow water heaters
- VWELS 1 tick

Code No. 27405000
Colour chrome
 white chrome



✓ Good
 Water Consumption: 8.70 litres/min
 Type of Product: Showerheads
 Brand: Hansgrohe
 Model: Raindance Classic 240 27405
 Reg no.: 02/2014/121896

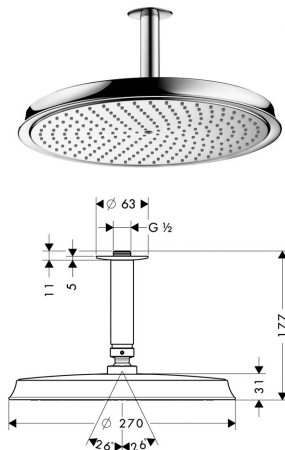

Raindance Classic Air Plate Overhead Shower Ø 300mm DN15 with ceiling connector 100mm

- shower head size: 300 mm
- spray type: RainAir
- fully chrome-plated spray disc
- material spray disc: metal
- ceiling connection length: 100 mm
- installation type: ceiling
- connection thread G 1/2
- connection dimension: DN15
- not suitable for continuous flow water heaters
- VWELS 1 tick

Code No. 27406000
Colour chrome



✓ Good
 Water Consumption: 8.50 litres/min
 Type of Product: Showerheads
 Brand: Hansgrohe
 Model: Raindance Classic 27406
 Reg no.: 02/2014/121895

Overhead Shower

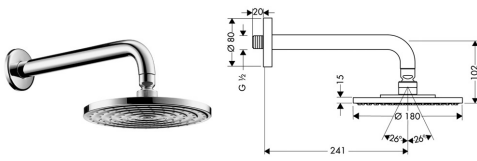

**Raindance Air Overhead Shower
180mm EcoSmart, DN15
with shower arm**

- extra wide shower spray with AirPower technology, QuickClean system
- with shower arm 241 mm, Ø 23 mm
- with pivot joint and security nut
- with wall mounting plate
- suitable for continuous flow water heaters, if the flow pressure at the mixer is a minimum of 0.15 MPa
- VWELS 2 ticks

Code No. 27462000E

Colour chrome



✓✓✓ Very Good
Water Consumption: 6.50 litres/min
Type of Product: Showerheads
Brand: Hansgrohe
Model: Raindance Air Overhead Shower 180 Eco 27462E
Reg no.: 02/2012/114616

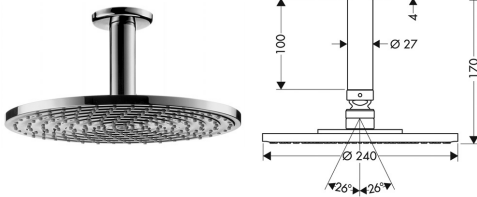

**Raindance S 240 Air 1jet overhead shower
with ceiling connector 100mm**

- shower head size: 240mm
- overhead shower angle adjustable
- spray type: RainAir
- fully chrome-plated spray disc
- material spray disc: metal
- ceiling connection length: 100mm
- connecting thread G 1/2
- connection dimensions: DN15
- VWELS 1 tick & 2 ticks

Code No. 27463000

27463000E

Colour chrome



✓ Good
Water Consumption: 8.40 litres/min
Type of Product: Showerheads
Brand: Hansgrohe
Model: Raindance Air 27463
Reg no.: 02/2014/119846



✓✓✓ Very Good
Water Consumption: 6.30 litres/min
Type of Product: Showerheads
Brand: Hansgrohe
Model: Raindance Air 27463E
Reg no.: 02/2014/119847

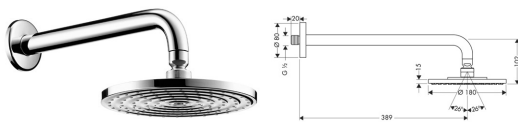

**Raindance S 180 Air 1jet overhead shower
with shower arm 390mm**

- shower arm length: 390mm
- spray type: RainAir
- fully chrome-plated spray disc
- material spray disc: metal
- installation type: wall
- connection thread G 1/2
- connection dimensions: DN15
- VWELS 1 tick & 2 ticks

Code No. 27468000

27468000E

Colour chrome



✓ Good
Water Consumption: 8.40 litres/min
Type of Product: Showerheads
Brand: Hansgrohe
Model: Raindance Air 27468000
Reg no.: 02/2014/119640



✓✓✓ Very Good
Water Consumption: 6.90 litres/min
Type of Product: Showerheads
Brand: Hansgrohe
Model: Raindance Air 27468E
Reg no.: 02/2014/119641

Overhead Shower

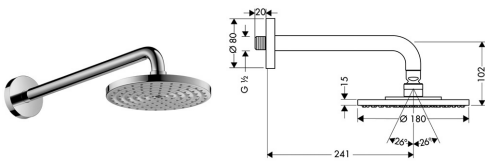

**Raindance Plate Overhead Shower
180mm DN15 with shower arm**

- extra wide shower spray
- QuickClean system
- with shower arm 241 mm, Ø 23 mm
- with pivot joint and security nut
- with wall mounting plate
- suitable for continuous flow water heaters, if the flow pressure at the mixer is a minimum of 0.15 MPa
- VWELS 2 tick

Code No. 27471000E

Colour chrome



✓✓ Very Good

Water Consumption: 6.70 litres/min

Type of Product: Showerheads

Brand: Hansgrohe

Model: Raindance Wall Mounted

Overhead Shower 180

27471E

Reg no.: 02/2012/114617

Overhead Shower

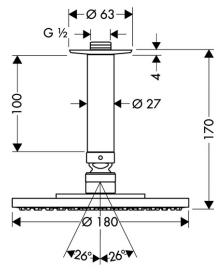

**Raindance Plate Overhead Shower
180mm DN15 with ceiling connector**

- extra wide shower spray
- QuickClean system
- with ceiling connector 100mm
- with pivot joint and security nut
- suitable for continuous flow water heaters, if the flow pressure at the mixer is a minimum of 0.15MPa
- VWELS 2 ticks

Code No. 27472000E

Colour chrome



✓✓ Very Good

Water Consumption: 7.00 litres/min

Type of Product: Showerheads

Brand: Hansgrohe

Model: Raindance 27472

Reg no.: 02/2014/120492

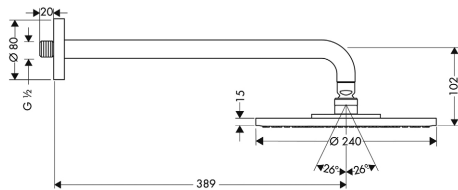

**Raindance S 240 Air 1jet
Overhead Shower
with Shower arm 390mm**

- shower head size: 240mm
- shower arm length: 390mm
- overhead shower angle adjustable
- spray type: RainAir
- fully chrome-plated spray disc
- material spray disc: metal
- installation type: wall
- connecting thread G 1/2
- connection dimensions: DN15
- VWELS 1 tick & 2 ticks

Code No. 27474000

27474000E

Colour chrome



✓ Good

Water Consumption: 8.80 litres/min

Type of Product: Showerheads

Brand: Hansgrohe

Model: 27474000

Reg no.: 02/2014/119766



✓✓ Very Good

Water Consumption: 6.80 litres/min

Type of Product: Showerheads

Brand: Hansgrohe

Model: 27474E

Reg no.: 02/2014/119767

Overhead Shower

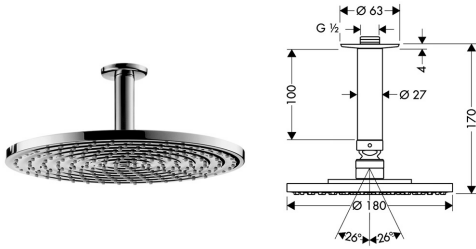

Raindance Air Plate Overhead Shower 240mm DN15 with ceiling connector

- extra wide shower rain
- AirPower technology
- QuickClean system
- with ceiling connector 100mm
- with pivot joint and security nut
- suitable for continuous flow water heaters from 24kW, if the flow pressure at the mixer is a minimum of 0.2MPa
- VWELS 1 tick & 2 ticks

Code No. 27477000
27477000E
Colour chrome



✓ Good
Water Consumption: 7.30 litres/min
Type of Product: Showerheads
Brand: Hansgrohe
Model: Raindance Air Overhead Shower 240 27477
Shower 240 27477
Reg no.: 02/2012/114607



✓✓ Very Good
Water Consumption: 6.20 litres/min
Type of Product: Showerheads
Brand: Hansgrohe
Model: Raindance 240 27477E
Reg no.: 02/2014/119845

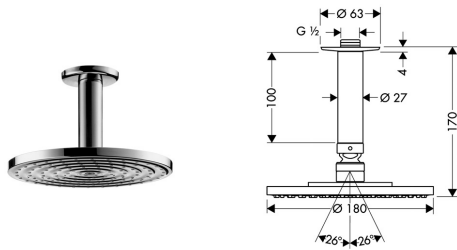

Raindance Air Plate Overhead Shower 180mm DN15 with ceiling connector

- extra wide shower spray
- AirPower technology
- QuickClean system
- with ceiling connector 100mm
- with pivot joint and security nut
- suitable for continuous flow water heaters, if the flow pressure at the mixer is a minimum of 0.15MPa
- VWELS 1 tick

Code No. 27478000
Colour chrome



✓ Good
Water Consumption: 7.10 litres/min
Type of Product: Showerheads
Brand: Hansgrohe
Model: Raindance Air Overhead Shower 180 27478
Reg no.: 02/2012/114608

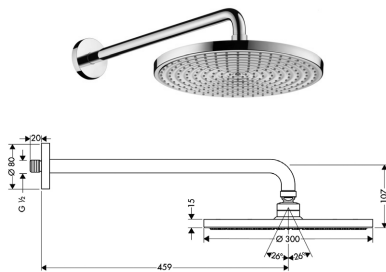

Raindance S 300 Air 1jet Overhead Shower with Shower Arm 450mm

- shower head size: 300mm, shower arm length: 460mm
- overhead shower angle adjustable
- spray type: RainAir
- fully chrome-plated spray disc
- material spray disc: metal, installation type: wall
- connecting thread G 1/2
- connection dimensions: DN15
- VWELS 1 tick

Code No. 27492000
Colour chrome



✓ Good
Water Consumption: 8.50 litres/min
Type of Product: Showerheads
Brand: Hansgrohe
Model: 27492000
Reg no.: 02/2014/119768

Overhead Shower

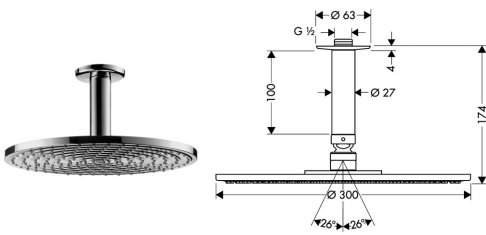

Raindance Air Plate Overhead Shower 300mm DN15 with ceiling connector

- wide shower rain with AirPower technology
- QuickClean system
- with ceiling connector 100mm
- with pivot joint and security nut
- not suitable for continuous flow water heaters
- VWELS 1 tick & 2 ticks

Code No. 27494000
27494000E
Colour chrome



✓ Good
Water Consumption: 8.00 litres/min
Type of Product: Showerheads
Brand: Hansgrohe
Model: 27494000
Reg no.: 02/2014/119769



✓✓ Very Good
Water Consumption: 6.60 litres/min
Type of Product: Showerheads
Brand: Hansgrohe
Model: Raindance Air Overhead Shower 300 27494E
Reg no.: 02/2012/114619

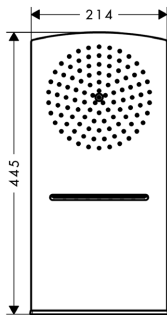
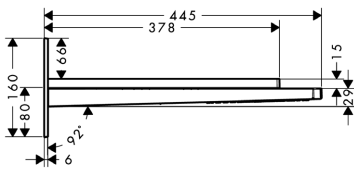

Raindance Rainfall 180 Air 2jet DN15

- overhead shower system for wall mounting
- flat profile 210 x 450mm
- 2 spray modes:
 - RainAir shower spray, 180mm with AirPower technology,
 - RainFlow flood jet, 170mm wide
- QuickClean anti-limescale system
- connection block for mounting on the iBox universal
- VWELS 1 tick

for use with:

- basic set iBox universal no.01800180

Overhead shower must be operated with 2 consumers (Trio Diverter Valve)

Code No. 28433000
28433400
Colour chrome
white chrome



✓ Good
Water Consumption: 8.50 litres/min
Type of Product: Showerheads
Brand: Hansgrohe
Model: Raindance Rainfall 180 Air 2 Jet 28433
Reg no.: 02/2012/114482

Overhead Shower

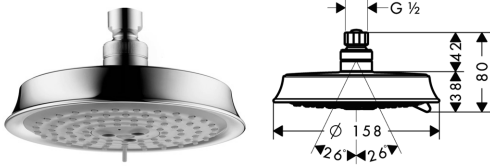

Code No. 28471000

Colour chrome

**Raindance Classic 150 Air 3jet
Overhead Shower DN15**

- shower head size: 150 mm
- spray type: RainAir, WhirlAir, Mix
- flow rate RainAir spray (at 0.3 MPa): 16 l/min
- flow rate WhirlAir spray (at 0.3 MPa): 12 l/min
- flow rate Mix spray (at 0.3 MPa): 18 l/min
- spray type alternation: adjustment with shift on overhead shower
- grey spray disc
- material spray disc: plastic
- installation type: ceiling or wall
- connection thread G 1/2
- connection dimension: DN15
- suitable for continuous flow water heaters with an output of 18 kW
- VWELS 1 ticks



✓ Good

Water Consumption: 8.80 litres/min

Type of Product: Showerheads

Brand: Hansgrohe

Model: Raindance Classic 28471

Reg no.: 02/2014/120611

Hand Shower

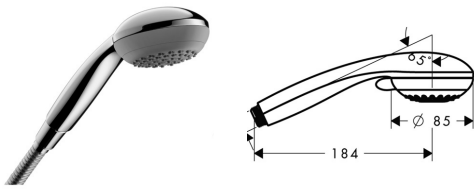

Crometta 85 Variojet Hand Shower DN15

- 2 spray modes: Normal (wide spray) and Vario (concentrated spray)
- QuickClean system
- suitable for continuous flow water heaters
- VWELS 1 tick & 2 ticks

Code No. 28562000
28562000E
Colour chrome



✓ Good
Water Consumption: 8.50 litres/min
Type of Product: Showerheads
Brand: Hansgrohe
Model: 28562000
Reg no.: 02/2014/119775



✓✓ Very Good
Water Consumption: 6.90 litres/min
Type of Product: Showerheads
Brand: Hansgrohe
Model: Crometta 85 Vario Hand Shower 28562E
Reg no.: 02/2012/114634

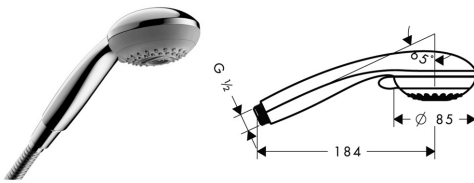

Crometta 85 Multi 3jet Hand Shower DN15

- 3 spray modes: Normal, Massage, Soft
- QuickClean system
- suitable for continuous flow water heaters
- VWELS 1 tick & 2 ticks

Code No. 28563000
28563000E
Colour chrome



✓ Good
Water Consumption: 7.30 litres/min
Type of Product: Showerheads
Brand: Hansgrohe
Model: Crometta 85 Multi Hand Shower 28563
Reg no.: 02/2012/114613



✓✓ Very Good
Water Consumption: 6.90 litres/min
Type of Product: Showerheads
Brand: Hansgrohe
Model: Crometta 85 28563E
Reg no.: 02/2014/121586

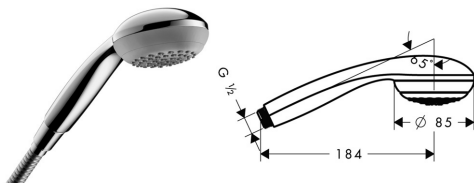

Crometta 85 Mono hand shower

- shower head size: 85mm
- spray type: normal spray
- with internal water conduction
- rinseable dirt filter
- connecting thread G 1/2
- connection dimension: DN15
- suitable for continuous flow water heaters
- VWELS 1 tick & 2 ticks

Code No. 28585000
28585000E
Colour chrome



✓ Good
Water Consumption: 7.60 litres/min
Type of Product: Showerheads
Brand: Hansgrohe
Model: Crometta 85 One Jet Hand Shower 28585
Reg no.: 02/2013/117610



✓✓ Very Good
Water Consumption: 6.50 litres/min
Type of Product: Showerheads
Brand: Hansgrohe
Model: Crometta 85 One Jet Hand Shower 28585E
Reg no.: 02/2013/117611

Overhead Shower

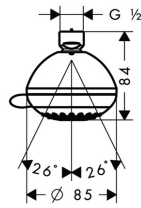
**Crometta 85 Variojet
Overhead Shower**

- shower head size: 85mm
- overhead shower angle adjustable
- spray type: normal spray, Vario spray
- spray type alternation: adjustment with shift on overhead shower
- grey spray disc
- material spray disc: plastic
- installation type: ceiling or wall
- connecting thread G 1/2
- connection dimensions: DN15
- VWELS 1 tick

Code No. 28424000

Colour chrome

✓ Good

Water Consumption: 8.50 litres/min

Type of Product: Showerheads

Brand: Hansgrohe

Model: 28424000

Reg no.: 02/2014/119771

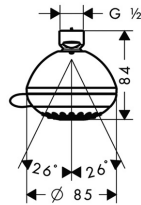
**Crometta 85 Multi
Overhead Shower**

- shower head size: 85mm
- overhead shower angle adjustable
- spray type: normal spray, Mono, massage spray
- spray type alternation: adjustment with shift on overhead shower
- grey spray disc
- material spray disc: plastic
- installation type: ceiling or wall
- connecting thread G 1/2
- connection dimensions: DN15
- VWELS 1 tick

Code No. 28425000

Colour chrome

✓ Good

Water Consumption: 8.50 litres/min

Type of Product: Showerheads

Brand: Hansgrohe

Model: 28425000

Reg no.: 02/2014/119772

Hand Shower

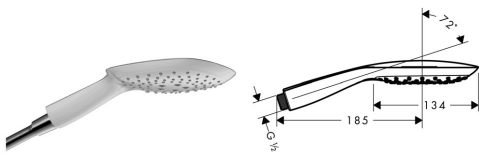

PuraVida 150 3jet Hand Shower DN15

- double-shell hand shower
- two-coloured version with white spray disc
- extra large shower head Ø134mm
- alternation of spray modes by Select push-button
- 3 spray modes: RainAir, CaresseAir, Mix
- AirPower technology
- QuickClean anti-limescale system
- rinseable dirt filter
- suitable for continuous flow water heaters from 21 KW upwards
- VWELS 1 tick

Code No. 28557000
28557400
Colour pure chrome
white chrome



✓ Good
Water Consumption: 7.10 litres/min
Type of Product: Showerheads
Brand: Hansgrohe
Model: PuraVida 150 3 jet Hand Shower 28557
Reg no.: 02/2012/114611

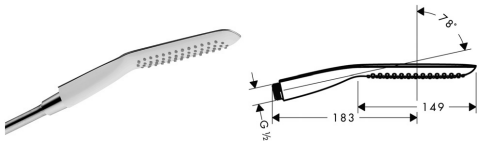

PuraVida 120 1jet Hand Shower DN15

- double-shell hand shower
- two-coloured version with white spray disc
- wide rain spray
- AirPower technology
- QuickClean anti-limescale system
- rinseable dirt filter
- suitable for continuous flow water heaters
- quality mark under application
- VWELS 1 tick & 2 ticks

Code No. 28558000
28558000E
28558400
28558400E
Colour pure chrome
white chrome



✓ Good
Water Consumption: 7.00 litres/min
Type of Product: Showerheads
Brand: Hansgrohe
Model: PuraVida 120 1 jet Hand Shower 28558
Reg no.: 02/2012/114612



✓✓ Very Good
Water Consumption: 7.00 litres/min
Type of Product: Showerheads
Brand: Hansgrohe
Model: PuraVida 120 28558E
Reg no.: 02/2014/120490

Hand Shower

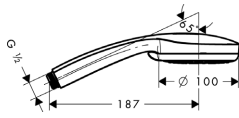
**Croma 100 Vario Hand Shower DN15**

- large shower head Ø 100mm
- spray system with 4 settings: Rain, Normal, Shampoo, Massage
- variable spray strength
- QuickClean system
- suitable for continuous flow water heaters
- rinseable dirt filter
- VWELS 1 tick

Code No. 28535000**Colour** chrome

✓ Good

Water Consumption: 7.50 litres/min

Type of Product: Showerheads

Brand: Hansgrohe

Model: Croma E100 Vario Hand Shower 28535

Reg no.: 02/2012/114610

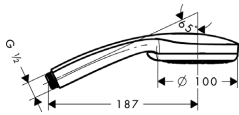
**Croma 100 Multi Hand Shower DN15**

- large shower head Ø 100mm
- 3 spray modes: Rain, Mono, Massage
- QuickClean system
- suitable for continuous flow water heaters
- rinseable dirt filter
- VWELS 1 tick & 2 ticks

Code No. 28536000

28536000E

Colour chrome

✓ Good

Water Consumption: 8.30 litres/min

Type of Product: Showerheads

Brand: Hansgrohe

Model: 28536000

Reg no.: 02/2014/119774



✓✓ Very Good

Water Consumption: 6.90 litres/min

Type of Product: Showerheads

Brand: Hansgrohe

Model: Croma E100 Multi Hand

Shower 28536E

Reg no.: 02/2012/114632

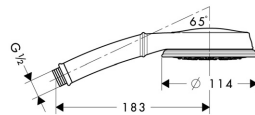
**Croma 100 Classic Multi Hand Shower**

- shower head size: 114 mm
- spray type adjustment by turning spray disc
- spray type: Rain, Mono, Massage spray
- with internal water conduction
- rinseable dirt filter
- connection thread G 1/2
- connection dimension: DN15
- suitable for continuous flow water heaters
- VWELS 1 tick & 2 ticks

Code No. 28539000

28539000E

Colour chrome

✓ Good

Water Consumption: 8.10 litres/min

Type of Product: Showerheads

Brand: Croma

Model: 28539

Serial no.: 02/2014/121069



✓✓ Very Good

Water Consumption: 7.00 litres/min

Type of Product: Showerheads

Brand: Croma

Model: 28539E

Reg no.: 02/2014/121070

Overhead Shower

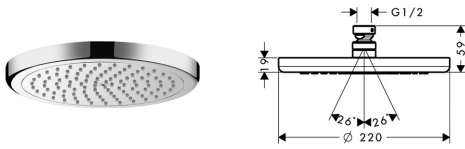
**Croma 220 Air 1jet Overhead Shower**

- shower head size: 220mm
- overhead shower angle adjustable
- spray type: RainAir
- fully chrome-plated spray disc
- material spray disc: metal
- installation type: ceiling or wall
- connecting thread G 1/2
- connection dimension: DN15
- spray disc removable for cleaning
- VWELS 1 tick & 2 ticks

Code No. 26464000
26464000E
Colour chrome



✓ Good
Water Consumption: 7.60 litres/min
Type of Product: Showerheads
Brand: Hansgrohe
Model: 26464
Reg no.: 02/2013/118412

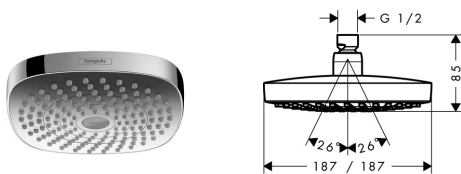

✓✓ Very Good
Water Consumption: 6.20 litres/min
Type of Product: Showerheads
Brand: Hansgrohe
Model: 26464E
Reg no.: 02/2013/118413

**Croma Select E 180 2jet Overhead Shower**

- shower head size: 180 mm x 180 mm
- spray type: Rain, IntenseRain
- spray type alternation: Select button on overhead shower
- spray disc surface in two variants: chrome or white
- material spray disc: plastic
- connection thread G 1/2
- connection dimension: DN15
- VWELS 1 tick & 2 ticks

Code No. 26524000
26524000E
Colour chrome



✓ Good
Water Consumption: 7.30 litres/min
Type of Product: Showerheads
Brand: Hansgrohe
Model: Croma Select E 180 2 Jet
overhead shower 26524
Serial No.: 02/2015/122845

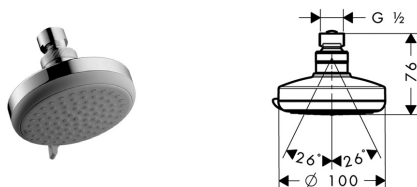

✓✓ Very Good
Water Consumption: 5.30 litres/min
Type of Product: Showerheads
Brand: Hansgrohe
Model: Croma Select E 180 2 Jet
overhead shower 26524E
Serial No.: 02/2015/122846

**Croma 100 Vario Overhead Shower DN15**

- large shower head Ø 100mm
 - spray system with 4 settings: Rain, Normal, Shampoo, Massage
 - variable jet strength
 - QuickClean system
 - min. flow pressure 0.08MPa at 10 l/min.
 - suitable for continuous flow water heaters
 - VWELS 1 tick
- for use with: shower arm no.27411000

Code No. 27441000
Colour chrome



✓ Good
Water Consumption: 7.50 litres/min
Type of Product: Showerheads
Brand: Hansgrohe
Model: Croma E 100 Vario Overhead Shower 27441
Reg no.: 02/2012/114605

Overhead Shower

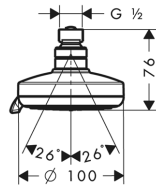
**Croma 100 Multi Overhead Shower**

- shower head size: 100 mm
- spray type: Mono, Massage spray, Rain
- spray type: alternation: adjustment with shift on overhead shower
- grey spray disc
- material spray disc: plastic
- installation type: ceiling or wall
- connection thread $G \frac{1}{2}$
- connection dimension: DN15
- VWELS 1 tick & 2 ticks

Code No. 27443000
27443000E

Colour chrome



✓ Good
Water Consumption: 8.40 litres/min
Type of Product: Showerheads
Brand: Hansgrohe
Model: Croma E 27443000
Reg no.: 02/2014/119645

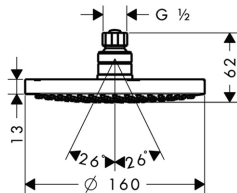

✓✓ Very Good
Water Consumption: 7.00 litres/min
Type of Product: Showerheads
Brand: Hansgrohe
Model: Croma E 27443E
Reg no.: 02/2014/119646

**Croma 160 Plate Overhead Shower with swivel joint DN15**

- large shower head Ø 160mm
- wide shower rain
- chromed spray surface
- with swivel joint DN15
- QuickClean anti-limescale system
- VWELS 1 tick & 2 ticks for use with
- shower arm (no.27412000)

Code No. 27450000
27450000E

Colour chrome



✓ Good
Water Consumption: 7.10 litres/min
Type of Product: Showerheads
Brand: Hansgrohe
Model: Croma 160 Overhead Shower
27450
Reg no.: 02/2012/114606



✓✓ Very Good
Water Consumption: 5.30 litres/min
Type of Product: Showerheads
Brand: Hansgrohe
Model: Croma 160 Overhead Shower
27450E
Reg no.: 02/2012/114615

Overhead Shower

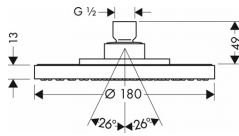

180 1jet plate overhead shower

- overhead shower angle adjustable
- spray type: RainAir
- fully chrome-plated spray disc
- material spray disc: metal
- installation type: ceiling or wall
- connecting thread G 1/2
- connection dimension: DN15
- suitable for continuous flow water heaters with an output of 18kW
- VWELS 1 tick & 2 ticks

Code No. 28484000
 28484000E
Colour chrome



✓ Good
 Water Consumption: 7.50 litres/min
 Type of Product: Showerheads
 Brand: Axor
 Model: Massaud Overhead Shower
 One Jet 180mm 28484
 Reg no.: 02/2013/117904



✓✓ Very Good
 Water Consumption: 6.20 litres/min
 Type of Product: Showerheads
 Brand: Axor
 Model: Massaud Overhead Shower
 One Jet 180mm 28484E
 Reg no.: 02/2013/117905

Overhead Shower

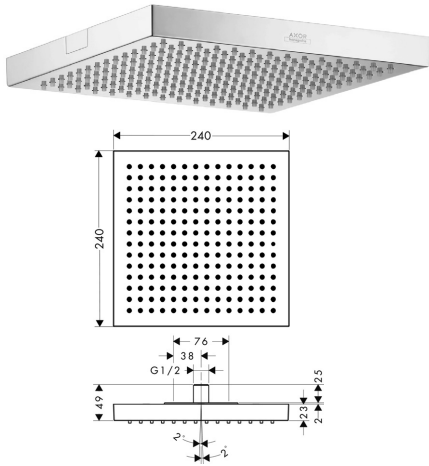

24 x 24 1jet Overhead Shower

- shower head size: 240 x 240mm
- spray type: RainAir
- fully chrome-plated spray disc
- material spray disc: metal
- spray disc removeable for cleaning
- installation type: ceiling
- connection thread G 1/2
- connection dimension: DN15
- not suitable for continuous flow water
- VWELS 1 tick

Code No. 10924000

Colour chrome



✓ Good

Water Consumption: 8.80 litres/min

Type of Product: Showerheads

Brand: Axor

Model: Starck KB 240 10924

Serial no.: 02/2014/121898

Overhead Shower

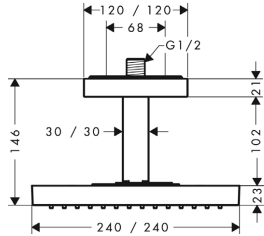
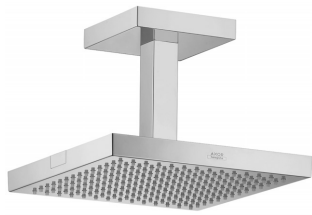

Axor 24 x 24 1jet Overhead Shower with Ceiling Connector

- shower head size: 240 x 240mm
- spray type: RainAir
- fully chrome-plated spray disc
- material spray disc: metal
- spray disc removeable for cleaning
- brass connection length: 103mm
- installation type: ceiling
- connecting thread G 1/2
- connection dimension: DN15
- not suitable for continuous flow water heaters
- VWELS 1 tick

Code No. 10929000

Colour chrome



✓ Good
 Water Consumption: 8.00 litres/min
 Type of Product: Showerheads
 Brand: Axor
 Model: 10929000
 Reg no.: 02/2014/119758

Hand Shower

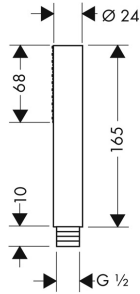

Axor Starck 1jet baton hand shower

- spray type: Normal spray
- not suitable for rim-/ tile-mounted mixers
- metal cover
- rinseable dirt filter
- connection thread G 1/2
- connection dimension: DN15
- suitable for continuous flow water heaters
- VWELS 1 tick & 2 ticks

Code No. 10531000
10531000E
Colour chrome



✓ Good
Water Consumption: 8.20 litres/min
Type of Product: Showerheads
Brand: Axor
Model: Starck HB 10531
Serial no.: 02/2014/120488



✓✓ Very Good
Water Consumption: 7.00 litres/min
Type of Product: Showerheads
Brand: Axor
Model: Starck HB 10531E
Serial no.: 02/2014/120489

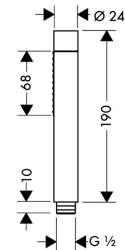

Baton Hand Shower 2jet, DN15

- body out of metal
- 2 spray modes: Normal and Soft spray
- QuickClean cleaning system
- suitable for continuous flow water heaters
- not suitable for rim-/tile-mounted faucets
- P-IX 9990/IB
- VWELS 1 tick & 2 ticks

Code No. 28532000
28532000E
Colour chrome



✓ Good
Water Consumption: 7.10 litres/min
Type of Product: Showerheads
Brand: Axor
Model: Starck Hand Shower 28532
Reg no.: 02/2012/114609



✓✓ Very Good
Water Consumption: 5.60 litres/min
Type of Product: Showerheads
Brand: Axor
Model: Starck Hand Shower 28532E
Reg no.: 02/2012/114630

Overhead Shower

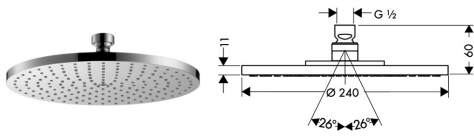

Plate Overhead Shower Ø 240mm DN15

- extra wide shower rain
 - AirPower technology
 - QuickClean system
 - with swivel joint and security nut
 - suitable for continuous flow water heaters, if the flow pressure is a minimum of 0.15MPa
 - VWELS 1 tick & 2 ticks
- for use with:
- shower arm 389mm no.27413xxx
 - ceiling connector 100mm no.27479xxx

Code No. 28494000
 28494000E
Colour chrome



✓ Good
 Water Consumption: 7.40 litres/min
 Type of Product: Showerheads
 Brand: Axor
 Model: Starck Overhead shower 240mm
 Reg no.: 02/2013/116457



✓✓ Very Good
 Water Consumption: 6.60 litres/min
 Type of Product: Showerheads
 Brand: Axor
 Model: Starck Overhead Shower 240 28494E
 Reg no.: 02/2012/114620

Citterio M Overhead Shower

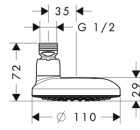

Overhead Shower, DN15

- rain jet
- QuickClean system for use with:
 - swivel ball pivot
 - shower arm 230mm no.27412000
 - wall plate no.34612000
- VWELS 1 tick & 2 ticks

Code No. 34610000
 34610000E
Colour chrome



✓ Good
 Water Consumption: 8.00 litres/min
 Type of Product: Showerheads
 Brand: Axor
 Model: Citterio M Overhead Shower
 34610
 Reg no.: 02/2013/116460



✓✓ Very Good
 Water Consumption: 6.90 litres/min
 Type of Product: Showerheads
 Brand: Axor
 Model: Citterio M Overhead Shower
 34610E
 Reg no.: 02/2013/116461

Citterio Overhead Shower

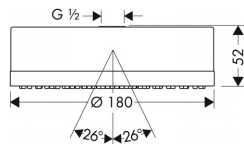
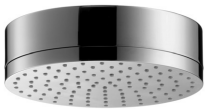

Axor Citterio 180 1jet overhead shower, DN15

- shower head size: 180mm
- overhead shower angle adjustable
- spray type: Rain
- fully chrome-plated spray disc
- material spray disc: metal
- installation type: ceiling or wall
- connecting thread G 1/2
- VWELS 1 tick & 2 ticks

Code No. 28489000
 28489000E
Colour chrome



✓ Good
 Water Consumption: 7.80 litres/min
 Type of Product: Showerheads
 Brand: Axor
 Model: Citterio Overhead Shower
 28489
 Reg no.: 02/2013/117612



✓✓ Very Good
 Water Consumption: 6.50 litres/min
 Type of Product: Showerheads
 Brand: Axor
 Model: Citterio Overhead Shower
 28489E
 Reg no.: 02/2013/117613

Overhead Shower

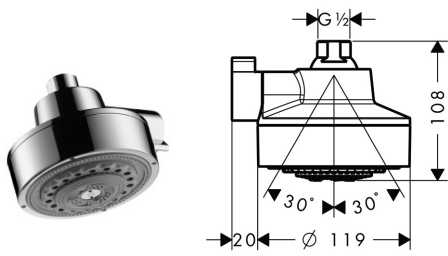

Axor Citterio 3jet overhead shower

- shower head size: 120 mm
- spray type: Normal spray, Massage spray, soft spray
- spray type alternation: adjustment with shift on overhead shower
- grey spray disc
- material spray disc: plastic
- installation type: ceiling or wall
- connection thread G 1/2
- connection dimension: DN15
- VWELS 1 tick

Code No. 39740000

Colour chrome



✓ Good

Water Consumption: 8.00 litres/min

Type of Product: Showerheads

Brand: Axor

Model: Axor Citterio 3 jet overhead shower 39740

Serial No.: 02/2015/122921

Hand Shower

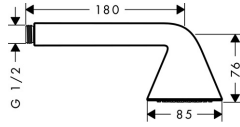
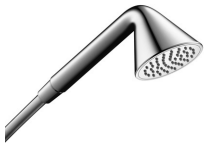

Axor 1jet hand shower designed by Front

- shower head size: 85 mm
- spray type: Eco spray, Stream
- suitable for rim-/ tile-mounted mixers
- with internal water conduction
- rinseable dirt filter
- connection thread G 1/2
- connection dimension: DN15
- suitable for continuous flow water heaters
- VWELS 1 tick & 2 ticks

Code No. 26025000
 26025000E
Colour chrome



✓ Good
 Water Consumption: 8.30 litres/min
 Type of Product: Showerheads
 Brand: Axor
 Model: Front HB 26025
 Reg no.: 02/2014/120491



✓✓ Very Good
 Water Consumption: 7.00 litres/min
 Type of Product: Showerheads
 Brand: Axor
 Model: Front HB 26025E
 Reg no.: 02/2014/121584

Overhead Shower

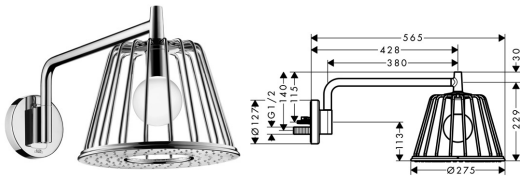

Axor LampShower 1jet with shower arm designed by Nendo

- shower head size: 275 mm
- shower arm length: 380 mm
- shower arm swivels by 150°
- spray type: Rain
- spray zones: special spray image from placed inside spray nozzles on the inner diameter
- fully chrome-plated spray disc
- material spray disc: metal
- spray disc removable for cleaning
- installation type: wall
- connection thread G 1/2
- connection dimension: DN15
- with integrated lighting
- illuminant: 12 Volt DC 5 Watt IPX5 2700K
- In: 100 - 240 Volt AC / 50 - 60 Hz
- Out: 12 Volt DC / 12 Watt SELV
- scope of supply: includes 7 meter long connection cable and power supply, the power supply must be installed in accordance with DIN VDE 0100-701 outside the zones 0,1 and 2
- TÜV certified
- VWELS 1 tick

Code No. 26031000

Colour chrome



✓ Good
 Water Consumption: 8.80 litres/min
 Type of Product: Showerheads
 Brand: Axor
 Model: Nendo 26031000
 Serial no.: 02/2014/119639

Overhead Shower

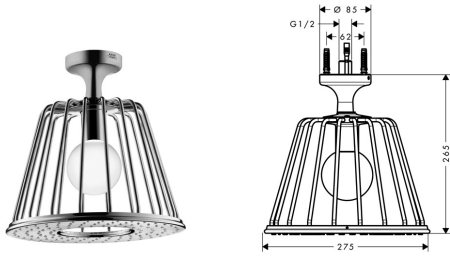

Code No. 26032000

Colour chrome

Axor LampShower 1jet with ceiling connector designed by Nendo

- shower head size: 275 mm
- spray type: Rain
- spray zones: special spray image from placed inside spray nozzles on the inner diameter
- fully chrome-plated spray disc
- material spray disc: metal
- spray disc removeable for cleaning
- brass ceiling connector
- ceiling connection length: 265 mm
- installation type: ceiling
- connection thread G 1/2
- connection dimension: DN15
- with integrated lighting
- illuminant: 12 Volt DC 5 Watt IPX5 2700K
- In: 100 - 240 Volt AC / 50-60 Hz
- Out: 12 Volt DC / 12 Watt SELV
- scope of supply: includes 7 meter long connection cable and power supply, the power supply must be installed in accordance with DIN VDE 0100-701 outside the zones 0,1 and 2
- TÜV certified
- VWELS 1 tick



✓ Good

Water Consumption: 8.20 litres/min

Type of Product: Showerheads

Brand: Axor

Model: Nendo 26032000

Serial no.: 02/2014/120493