

PROJECTS

Complete, affordable
bathroom solutions for
any bathroom

Product innovations for your bathroom plans

Logis[®] mixers and Croma[®] Select showers



Contents

Hansgrohe

Bathroom solutions

Advantages

Range

New: Logis® mixers and Croma® Select hand showers _____	4
Quality and advantages _____	6
Residential buildings _____	8
Hotels _____	14
Public areas in hotels _____	22
Presenting Logis® mixers _____	24
Mixer technology _____	26
Presenting Croma® Select hand showers _____	34
Shower technology _____	38
ShowerSelect® concealed thermostats _____	40
iBox® universal _____	42
Logis® Basin mixers/Bidet mixers _____	44
Logis® Bath mixers _____	50
Logis® Shower mixers _____	52
Croma® Select Hand showers _____	54
Croma® Select Shower sets _____	58
Croma® Select Combi sets/Overhead showers _____	60
Croma® Select Showerpipes _____	62
Crometta® 100 Hand showers _____	64
Crometta® 100 Shower sets/Overhead showers _____	66
Crometta® 100 Showerpipes _____	68
Ecostat® Thermostats for concealed installation _____	69
ShowerSelect® Thermostats/mixers for concealed installation _____	70
Logis® Accessories _____	74

Complete, quality bathrooms

Co-ordinated and atmospheric

Whether a hotel or a residential building:
wherever you are in the world,
you can rely on Hansgrohe
quality and reliability.

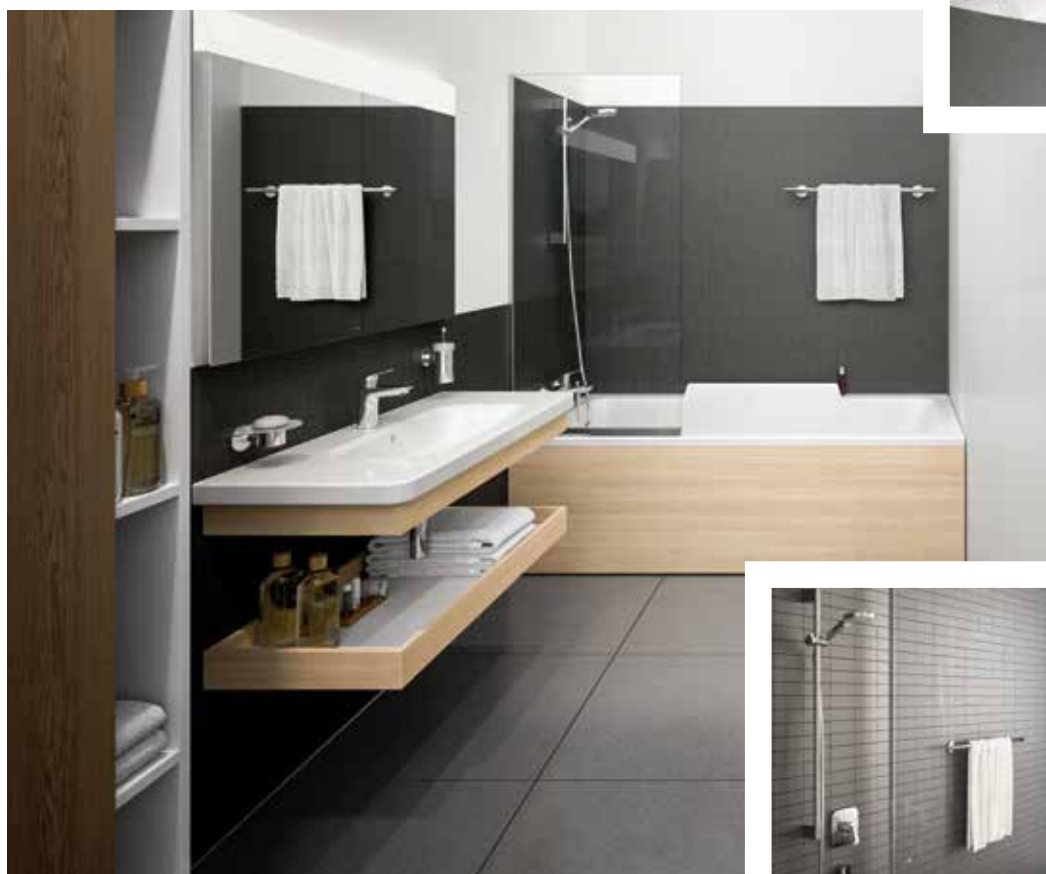

No two projects are the same, and every client has different requirements. But one thing is always the same. With Hansgrohe, you can get everything you need to make your bathroom individual and irresistible.

You'll find the right solution for any project and budget, and with the comprehensive range of additional services, you will receive all the support you need to make your project a success.

Bathroom planning made easy

Mixers, showers and accessories
for any requirement



Logis® 100
Single lever basin mixer

Croma® Select E Vario
Hand shower



When planning a bathroom, the important thing is to consider what the customers need and what the users want. So it's good to know that Hansgrohe's broad and carefully planned ranges have everything you need to fulfil any requirement. The best example of this: the new Logis mixer range and new Croma Select shower series. With products that appeal technically, visually and financially. Bathroom solutions that impress on every level.

Your advantages

- Also comply with all the relevant international standards and safety regulations
- Bathroom planning made easy thanks to the full range of two harmonising product lines for shower, basin and bathtub – including all the matching accessories
- Logis mixers with harmonious lines and in a choice of heights to meet any requirement
- Croma Select showers with intuitive operation at the touch of a button, a choice of spray types and in two designs to meet any showering requirement
- Reliable quality and a new design, providing excellent value for money

Made by Hansgrohe

Advantages during your planning phase

From the first basic evaluation and planning the installation to the tender to the building inspection: above all, bathroom planning in the planning sector is a long process. As your personal project partner, Hansgrohe and its technical experts will be by your side every step of the way. We also offer you lots of services and tools to make the process easier for you and therefore save you precious time.

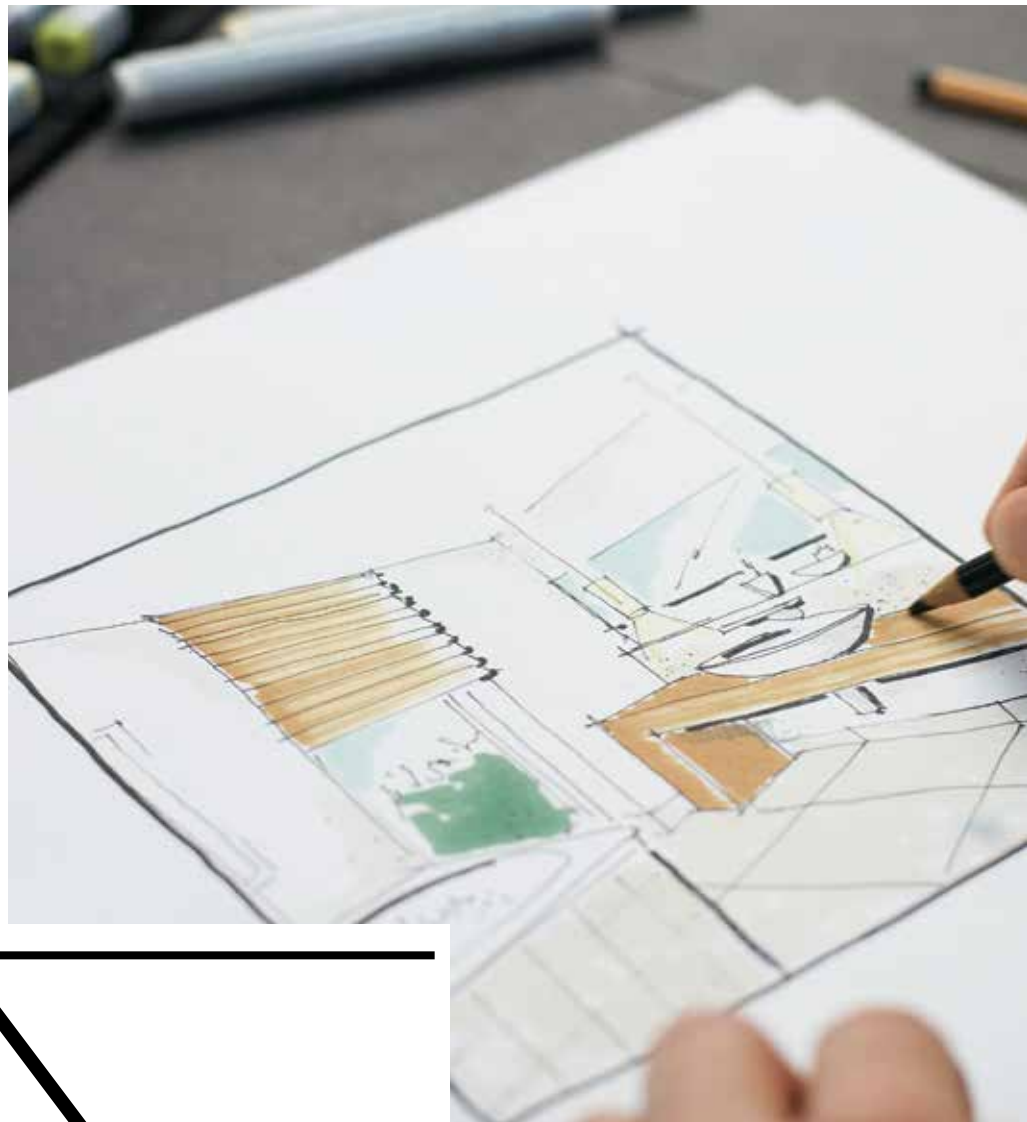

Personal contact

Whether you have questions concerning a specific project, want information on international standards or support with tenders: we have a team of specialist project advisers all over the world who will be pleased to help you.



Engineered in Germany

Hansgrohe offers you quality that you can pass on directly to your customers, assuring their long term satisfaction. Our research and development departments guarantee ground-breaking innovation. Top-quality material and extensive tests guarantee durability. German manufacturing know-how brings products that set new standards in functionality and comfort – made in Germany, enjoyed worldwide.



CERTIFIED

MIXERS AND SHOWERS

All Hansgrohe products comply with international standards. Furthermore, our products can be adapted individually to international efficiency standards – an important principle on the way to certifications such as LEED or BREEAM.

PROVEN

QUALITY

Our own research and development departments guarantee maximum quality. We also give you the maximum guarantee: all our products come with a voluntary manufacturer's guarantee for consumers with a 10-year availability guarantee on spares. This protects you against recourse claims.

pro.hansgrohe-int.com/guarantee

COURSES

BY PROFESSIONALS FOR PROFESSIONALS

Hansgrohe offers courses on every aspect of bathroom planning that can be tailored to your needs. The quality of the content is guaranteed by specialists with many years' experience.

COMPREHENSIVE

PLANNING DOCUMENTS

Save time when planning: you will receive 3D and 2D data to go with every Hansgrohe product as well as the corresponding tender texts for your AVA software or text editing. Simply download at:

pro.hansgrohe-int.com

TAILORED

SOLUTIONS

Whether changing the height of a mixer, engravings, different surface colours or the integration of a logo, we are able to manufacture your individual, bespoke product requirements, with no minimum order quantity.

pro.hansgrohe-int.com/manufacturing

ATTRACTIVE

DESIGN

Excellent comfort and user friendliness come first at Hansgrohe. We collaborate with internationally renowned designers to create high-quality products that are the expression of the equality between form and function. Because at Hansgrohe, design is never an end in itself.

Solutions for residential bathrooms

Fabulous mixers, showers and accessories

Maximum enjoyment is never a question of budget. This is confirmed by bathrooms that are created with Croma Select showers and Logis mixers. Apart from the modern looks, users will be delighted by the intuitive function, and exceptional user experience.

Your advantages

- Easy planning thanks to the wide range of products and installation options for any bathroom and customer request
- Satisfied customers thanks to the flexible range with a family-friendly value for money and built-in water saving functions
- Complimentary and co-ordinated bathroom planning thanks to harmonious design that integrates perfectly in the modern bathroom



1 Croma® Select and Logis® shower solutions

- Attractive products with a wide range of spray types in a choice of square or round designs – see page 35
- Select technology to easily change the spray type, at the touch of a button – see page 34
- Surface-mounted and concealed options for any installation situation

2 Croma® Select and Logis® bath solutions

- Hand showers in a square or round design in the Porter Set
- Surface-mounted and concealed options for any installation situation



◀ Sample installations

- **Shower:** Logis® single lever shower mixer concealed, Cromo® Select E Multi shower set 0.90 m, FixFit® hose connection and Rainrain waste system
- **Bathtub:** Logis® single lever bath mixer exposed, Cromo® Select E 1jet Porter set with Isiflex® flexible hose 1.25 m, bathtub: Duravit DuraStyle # 700297
- **Basin:** Logis® 100 single lever basin mixer, basin: Duravit DuraStyle # 034943

3 Logis® mixers

- Mixers in various ComfortZone heights from 70 to 210 to integrate with any basin option
- Design that harmonises with the current ceramics
- Sophisticated technology that saves water
- Strong surfaces that keep their looks for longer

4 Logis® accessories

- Matching accessories in the matching design language
- Practical solutions ranging from soap dishes to towel holders

Beautifully shaped and inviting

Shower and bath solutions for residential bathrooms



Sample installation 1

Logis® single lever shower mixer concealed, Croma® Select E Multi shower set 0.90 m, Fixfit® hose connection and Raindrain waste system

Installation options

Product highlights



Croma® Select E 180 2jet
Showerpipe

- Surface-mounted complete system with hand and overhead shower plus thermostat
- Ideal for modernisations, as it can be fitted to existing connections
- Changeover of hand and overhead shower spray at the touch of a button
- Flow quantity IntenseRain spray/Rain spray (at 3 bar): 16 l/min
- 400 mm long swivel shower arm with height-adjustable hand shower holder
- Adjustable hot water limiter with scald protection at 40 °C



Croma® Select S Multi
Shower set



Logis®
Single lever shower mixer exposed

Your advantages

- Freedom in shower design thanks to the variety of installation options
- Easier LEED certification thanks to more efficient products
- Overhead and hand showers with round (S) or square (E) designs, and with surfaces in chrome or chrome/white for any bathroom style – see page 35
- Flexibility in planning thanks to the option of surface-mounted and concealed solutions with thermostats or single lever mixers

Whether a house or block of flats, a bathtub, shower or both – Hansgrohe's broad product range will always help you find an impressive, practical solution.

Installation options



Logis®
Single lever bath mixer



Logis®
Exposed bath spout



Croma® Select S 1jet
Porter Set

Accessories

Whether a towel holder, soap dish or toothbrush tumbler, you will find the accessories to match your bathroom needs on page 74.

Benefits for customers

- Strong surfaces for easy cleaning
- Hansgrohe quality for lifetime value
- The intuitive operating concept provided at the touch of a button with the Croma Select hand and overhead showers is suitable for any age group – see page 34
- Save water and energy with intelligent EcoSmart technology – see page 30



Sample installation 2

Logis® single lever bath mixer exposed,
Croma® Select E 1jet Porter set with
Isiflex® flexible hose 1.25 m

Versatile and impressive

Basin solutions for residential bathrooms

The wide range of basins opens up new possibilities in bathroom design. The versatile Logis mixer range provides you with all the freedom you need to make these rooms excel – both in looks and in user friendliness.

Your advantages

- Flexible range of installation options for any project
- Satisfied customers guaranteed by the optimum mixer/basin combination – see ComfortZone test on pages 28/29

Benefits for customers

- Smart technologies that help to save water and energy, such as EcoSmart and Coolstart – see pages 30/31
- Splash-free mixer/basin combinations
- Various mixer heights for optimum freedom of movement



Sample installation 1

Logis® 100 single lever basin mixer,
basin: Duravit DuraStyle # 231965

Installation options



Logis® 70
Single lever basin mixer



Logis® 100
Single lever basin mixer



Logis® 210
Single lever basin mixer



Logis®
2-handle basin mixer



Logis®
3-hole basin mixer



Logis®
2-hole Single lever basin mixer
wall-mounted

Product highlights



Logis® 190
Single lever basin mixer

- ComfortZone 190 Projection 166 mm
- Perfect for wash bowls and free standing worktop basins
- Flow of just 5 l/min saves water and energy
- WELL certified
- Ceramic mixer system with adjustable temperature limit
- With pop-up waste system G1¼ or without a waste system
- Suitable for continuous-flow water heaters
- Connection: G ¾ connection pipes, connection size: DN15

Accessories

Whether a towel holder, soap dish or toothbrush tumbler, you will find the accessories to match your bathroom needs on page 74.

◀ Sample installation 2

Logis® 190 single lever basin mixer and Logis® towel holder, basin: Duravit DuraStyle # 034943

Solutions for hotel bathrooms

Harmonising mixers, showers and accessories

With the wide and varied range of Logis mixers and Croma Select showers you will be able to design bathrooms that are worthy of stars. In any hotel category.

Your advantages

- Fast, easy planning of coordinating and complementary bathrooms thanks to the complete range for shower, bathtub and basin
- EcoSmart technology reduces water consumption by up to 60% for easier compliance with certification requirements – see page 30
- Meets any and all customer requirements thanks to the broad range of showers with surface-mounted and concealed solutions for any standard plus attractive mixers that perfectly match the design language of modern ceramics
- Mixers and showers in appealing designs that blend harmoniously with any bathroom



Save water and energy

Especially in hotels, large quantities of water and energy can be saved. You can find out just how much with our hotel savings calculator:

pro.hansgrohe-int.com/savings-calculator

or mobile at

<http://m.pro.savings.hansgrohe-int.com>



Sample installations

- **Bathtub:** Logis® single lever bath mixer exposed, Croma® Select E Vario shower set 0.65 m, Logis® towel holder, bathtub: Duravit DuraStyle # 700297
- **Basin:** Logis® 100 single lever basin mixer, Logis® soap dish glass and toothbrush tumbler, basin: Duravit DuraStyle # 232010



1 Croma® Select showers and Logis® shower control

- Compliance with LEED requirements, energy-saving products comply with certification standards
- Hand showers with a flow of 7l/min available
- Bathtub can also be used as a fully-functioning shower
- Various installation options: from surface-mounted installations with a single lever mixer to concealed installations to thermostat and Showerpipe solutions

2 Logis® mixers

- Flexible space provided by mixers in various ComfortZone heights from 70 to 210
- Thanks to ComfortZone test, splash-tested mixer/basin combinations – see pages 28/29
- Water- and energy-saving technology to achieve certification standards
- Strong surfaces that keep their looks for longer

3 Logis® accessories

- Practical solutions from soap dish and toothbrush tumbler to a towel holder
- Matching accessories in the same design language

Variety and fascination

Shower solutions for hotel bathrooms



Sample installation 1
Croma® Select S 180 2jet Showerpipe

Installation options



Croma® Select E Vario
Shower Set 0.65 m



Croma® Select S Combi Set
with Ecostat® Comfort thermostat



Logis®
Single lever shower mixer concealed,
also Highflow version for overhead
shower with high flow rate available



Logis®
Single lever shower mixer exposed

Your advantages

- Freedom in shower design thanks to the variety of installation options
- Reduced water flow helps fulfil certification requirements
- Overhead and hand showers with surfaces in chrome or white/chrome are ideal for any bathroom style and taste
- Flexibility in planning thanks to the option of surface-mounted and concealed solutions with thermostats or single lever mixers

Make the most of your shower planning: from a wide range of surface-mounted versions for standard connections to space-saving concealed solutions for greater freedom of movement. And if you like, everything can be controlled at the touch of a button with Select. Find out more on pages 40/41.

Installation options

Product highlights



Croma® Select E 180 2jet
Overhead shower

- Chrome and white/chrome surfaces with round (S) or square (E) lines match any taste
- Two spray types: flat rain and intensive water spray
- Easy to change spray at the touch of a button
- Matching shower arms for ceiling and wall installation



Ecostat® E
Thermostat for
2 functions



Croma® Select E 1jet
Porter Set

Benefits for customers

- Fast payback: Costs quickly recouped by the low water and energy consumption of the Croma Select showers
- Extremely durable and long-lasting thanks to the high-quality manufacture
- Availability guaranteed for many years
- QuickClean technology for easy shower cleaning – see page 38
- Concealed control with mixer or thermostat technology, also with Select – see page 40



Sample installation 2

Croma® Select S 180 2jet overhead shower,
Croma® Select S Vario shower set 0.65 m,
ShowerSelect® S mixer for 2 functions

Relaxation and pleasure

Bathtub solutions for hotel bathrooms

A bathtub not only invites the guests to relax. You'll find even the planning process is relaxed. Thanks to the many different bathtub solutions, you'll be able to exceed any expectation with quality, design and maximum comfort in every hotel segment.

Your advantages

- Complete ideas for the bathroom including bathtub filler/outflow/overflow
- Wide range of solutions for every requirement from A to Z
- Countless possible combinations with showers in two designs and with numerous spray variations, and shower bars in various solutions

Benefits for customers

- Bathtub can also be used as a fully-functioning shower
- Strong surfaces for easy cleaning
- Easy-care, anti-kink shower hose



Sample installation 1

Logis® bath mixer exposed,
Croma® Select E Vario shower set 0.65 m

Installation options



Logis®
3-hole single lever bath mixer
for installation on the tub rim

Accessories

Whether a towel holder, soap dish or toothbrush tumbler, you will find the accessories to match your bathroom needs on page 74.



Product highlights



Croma® Select E Vario
Shower set 0.65 m

- Shower bar available in various heights
- Adjustable height and angle of hand shower
- Flexible positioning



Sample installation 2

Logis® single lever bath mixer exposed,
Croma® Select E Vario shower set 0.65 m,
bathtub: Duravit DuraStyle # 700297

Freedom and flexibility

Basin solutions for hotel bathrooms

Whatever the hotel category: Logis mixers in various heights will increase the personal ComfortZone for the guests. How to turn the basin into a spa area.

Your advantages

- Various mixer heights, to suit various basin options for greater freedom at the basin
- Save time planning with the ComfortZone test for tested mixer/basin combinations: no more irritating washer splashes, and plenty of space under the mixer – see pages 28/29
- Flow quantity of standard mixer: 5l/min – can be adapted to quantities of 2 to 5l/min (0.5-1.5 GPM) for specific projects
- Mixer design compatible with the shapes of modern ceramics

Benefits for customers

- Save water with EcoSmart technology that reduces the flow to 5l/min – see page 30
- Logis 70 and Logis 100 as the CoolStart version are available to reduce the warm water and energy required – see page 31



Sample installation 1

Logis® 100 single lever basin mixer,
Logis® soap dish and toothbrush tumbler,
basin: Duravit DuraStyle # 232010

Logis® mixer variants



Logis® 70
Single lever basin mixer



Logis® 190
Single lever basin mixer



Logis®
2-handle basin mixer



Logis®
3-hole basin mixer

Accessories

Whether a towel holder, soap dish or toothbrush tumbler, you will find the accessories to match your bathroom needs on page 74.

Product highlights



Logis® 100
Single lever basin mixer

- Excellent comfort at an attractive price
- Easy to clean thanks to the generous surface area
- Flow quantity 5 l/min and adjustable temperature limitation
- WELL certified
- LEED compliant
- Pop-up waste system G 1¼
- Suitable for continuous-flow water heaters
- Available as a CoolStart version and with lots of waste system options



Sample installation 2

Logis® 210 single lever basin mixer,
Logis® soap dish and toothbrush tumbler,
basin: Duravit DuraStyle # 232010



Solutions for public hotel areas

Smart mixers and accessories

Special rules apply if lots of people use the same bathroom. With the Logis mixer range, you can also make busy hotel areas such as the lobby or the restaurant WCs pleasant and inviting.

Your advantages

- Lots of options when planning thanks to the wide range of mixer variants and heights
- ComfortZone test with tested mixer/basin combinations for pleasant use without splashes – see pages 28/29
- LowFlow versions with a flow from just 2 l/min (0.5 GPM) as the foundation for certifications are possible for individual projects – see page 33

Benefits for customers

- CoolStart mixers that save energy with their low warm water consumption – see page 31
- The generous surfaces of the handle and mixer body are easy to clean
- Save time with the quick and easy installation – ideal with lots of mixers



Sample installation 1
Logis® 100 single lever basin mixer,
Logis® soap dispenser,
basin: Duravit DuraStyle # 037337



Logis® mixer variants



Logis® 70 CoolStart
Single lever basin mixer



Logis® 70
Pillar tap for small wash basins

Product highlights



Logis® 100 CoolStart
Single lever basin mixer



- In the basic position, only cold water flows, so hot water is only consumed when you need it. Saving money as you only heat the water you need.
- High potential savings of water and energy
- Available in two ComfortZone heights: 70 and 100 for optimum space
- Adjustable temperature limiter and suitable for continuous flow water heaters
- WELL certified



Logis®
Single lever basin mixer 195 mm
wall-mounted



Sample installation 2

Logis® 70 basin mixer,
Logis® soap dish,
basin: Duravit DuraStyle # 037337

Harmonious and homelike Logis® basin mixers

The design claim of the new Logis mixer line is high: every single product should pamper the eye and the hand in equal measure. The results are mixers that are pleasant to use and have rounded edges that make them the

perfect match for basins with soft shapes. They can be combined with a variety of ceramic designs, and are perfect for creating attractive bathrooms in the public, commercial and private sectors.



▲
PHOENIX DESIGN ■



Rounded shape of handle and basic set



High-quality, silent ceramic cartridge

Precise shoulder line and edges

EcoSmart technology

Clear, generous surfaces for easy cleaning

Low Class 1 noise development, so ideal for multifamily homes, hotels, and offices

Flexible connections make it easier to install the mixer

Comfort at all levels

Hansgrohe ComfortZone



The higher the mixer, the greater the flexibility in the daily use of water. We call this area between the mixer and the ceramic the ComfortZone. Whether a free-standing or wall-hung basin, recessed or built-in basin:

thanks to the various mixer heights, Hansgrohe gives you all the freedom you need to design the basin to suit your ideas and the customer's requirements.

Your advantages

- The right mixer for any ceramic installation option
- Various mixer heights to offer just the amount of freedom that your project requires

Benefits for customers

- High and swivelling mixers for greater freedom of movement
- More comfort with daily tasks such as shaving, brushing your teeth or washing your hair



Logis® 70



Logis® 100



Logis® 190



Logis® 210



▶
Logis® 100 single lever basin mixer,
basin: Duravit DuraStyle # 037337



▶ Logis® 210 single lever basin mixer with swivel spout, basin Duravit DuraStyle # 232010



▲ Whatever the installation situation: Logis® mixers harmonise elegantly and functionally with the majority of ceramic designs.
Logis® single lever basin mixer wall-mounted, basin Duravit DuraStyle # 034960

It's all just right for you

ComfortZone Test

The higher the mixer, the greater the usable space beneath it. Whether for filling tall containers or washing your hair in comfort. However, as the height of the mixer increases, so does the risk of annoying splashes. But the mixer shouldn't be too low either. Otherwise even washing your hands could be tricky. As a measure to eliminate these annoyances from the outset, Hansgrohe

developed the ComfortZone test. Under highly realistic conditions, Hansgrohe tests its mixers for their compatibility with the basins by leading manufacturers. All Logis mixers have also been tested in combination with a variety of ceramics. The results offer you peace of mind and confidence that the basin/mixer combination will meet your clients performance expectations.



Your advantages

- Extensive tests with basins by renowned manufacturers
- Save time in the selection process
- Easy planning and planning safety thanks to the provision of all item numbers, models and installed dimensions
- No splashes, plenty of space and a wide range of options – for satisfied customers who remain satisfied



Optimum planning: with over 8000 tested combinations

Utilise our know-how from thousands of tests: we will provide you with all the results from the test series free of charge. This overview of all of our tested mixer and basin combinations provides a sound basis for your recommendations. The PDF files with all the test findings are available at pro.hansgrohe-int.com/comfortzone-test

hansgrohe

Which Hansgrohe mixer suits which basin?

Basin with reference number

Durepuit		430 x 430			600 x 380		1000 x 480
		#070845.00	#231935.00	#037337.00	#031863.00	#034950.00	#232010.00
Logis 70 	#71070000						
	#71077000						
	#71078000		✓	✓ ^{b1}			
	#71072000						
	#71075000						
Logis 100 	#71071000	✓	✓	✓ ^{b1}		✓	
	#71073000						
	#71760000						
	#71100000						
Logis 100 	#71100000		✓	✓ ^{b1}		✓	
	#71107000						
	#71104000						
	#71105000						
Logis 190 	#71101000	✓	✓	✓ ^{b1}		✓	
	#71103000						
	#71106000						
Logis 190 	#71090000		✓	✓ ^{b1}	✓ ^{a2}	✓ ^{a1}	
	#71095000						
	#71091000		✓	✓ ^{b1}		✓	
Logis 210 	#71130000					✓	
	#71131000					✓	
Logis 200 	#71220000		✓	✓ ^{b1}		✓	
	#71221000		✓	✓ ^{b1}		✓	
Logis 100 	#71130000		✓	✓ ^{a2}	✓ ^{a2}	✓ ^{a2}	
	#71133000		✓	✓ ^{b1}		✓	

Matching tested combinations

Legende

a1 = 35mm
a2 = 50mm
a3 = 100mm

b1 = 60mm
b2 = 100mm

c1 = 150mm
c2 = 220mm

d1 = 35mm
d2 = 60mm
d3 = 100mm

e1 = 35mm
e2 = 50mm
e3 = 100mm

Mounting dimensions for various installations

Save more in moments

Mixer technology

EcoSmart



Thanks to EcoSmart technology, the water consumed by all Hansgrohe basin mixers is generally reduced to 5 l/min from the more usual 13 l/min. This also saves energy because less hot water needs to be heated. All this is made possible by air injection and the integrated EcoSmart system. To find out just

how much water and energy your project could save, go to the savings calculator at pro.hansgrohe-int.com/savings-calculator or mobile at <http://m.pro.savings.hansgrohe-int.com>

Your advantages

- Water consumption just 5 l/min for water saving as per standard EN 817
- Helps to comply with building certifications such as LEED
- Precision O ring for a constant flow even under fluctuating water pressure
- Rich, bubbling water spray thanks to the enrichment with air, and therefore fewer splashes
- Various mixers with country-specific flow quantities 2–5 l/min (0.5–1.5 GPM) available



CoolStart

Often, you only need cold water if you're just rinsing your hands. However, with standard mixers, the continuous flow water heater or circulation pump immediately switch on if the lever is in the middle position. With the Logis 70 and Logis 100 mixers with CoolStart technology, however, only cold

water runs if the lever is in the middle position. Hot water is not added until the lever is moved to the left. This helps to reduce the energy requirement and hence CO₂ emissions as well. This benefits the environment and appeals to building certifiers.

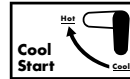

Your advantages

- In the basic position, only cold water flows without the continuous-flow water heater or circulation pump
- High potential savings of water and energy for hotels and public buildings



Logis® 100



Logis® 70

Project benefits included

Mixer technology

Certificates

Our products hold international certificates for flow quantities and efficiency - ECA, WRAS and Water label. Especially in projects, water and energy savings are important criteria for building certifications e.g. to DGNB, BREEAM or LEED - high standards that qualify our products for international projects.

Your advantages

- Confirmation of the highest water and energy efficiency
- Certified to various internationally recognised standards
- Quality seal as the base for certificates
- Compliance with LEED standards

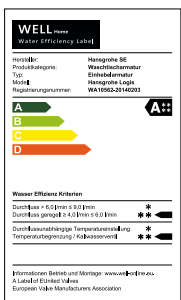

LowFlow

l/min
3,5

Cartridges with Hansgrohe's LowFlow technology help to comply with even the most stringent requirements. They have a limited opening angle and special spray formers, and so allow a flow of only 3.5 l/min (1 GPM) water - with the same mixer performance.



- ① With flow limiter
- ② Without flow limiter

Your advantages

- Savings in water and energy, compliance with e.g. LEED requirements
- Consistently low flow regardless of pressure
- Mixers with country-specific flow amounts available
- Precise temperature setting despite low flow quantity

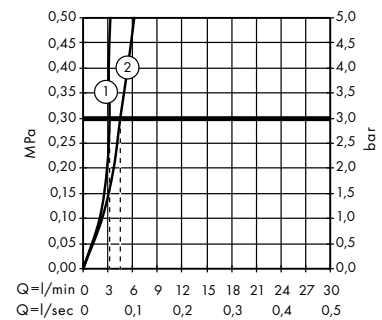

Logis® 100



Logis® 70

Select: It's all in the button

Croma® Select hand showers



Would you like to come out on top in every aspect of your shower design? Then make Croma Select hand showers your first choice. The attractive design in white/chrome with the round head (S) or soft square (E) will blend elegantly with any bathroom. You will also score for the excellent comfort: a light touch on the Select button is all it takes to switch

through the spray types. With the EcoSmart version it is also simple to keep operating costs down. That's because the reduced water flow (9 l/min with the Vario and Multi versions, and 7 l/min with the 1jet version) saves precious resources and supports compliance with building certificates such as LEED.



PHOENIX DESIGN ■



◀ **The heart of the shower**

Changing the spray type is easy and intuitive with the innovative Select button. This means easy, intuitive operation for every age group, including those with restricted mobility, and thus greater comfort and pleasure when showering. Not only that, as there are fewer protruding handles and levers, cleaning the shower is quicker and easier. The purely mechanical technology is low-maintenance and low-wear.



Various openings for different spray types

Attractive colour play in white/chrome

Easy to clean thanks to the QuickClean silicone jets

Change the spray type at the touch of a button

EcoSmart technology to reduce water consumption

Slender, ergonomic handle

Croma® Select S Multi Hand shower



Croma® Select E Vario Hand shower

Pleasure for any shower type

Croma® Select spray types



No two showers are the same. With Croma Select hand showers, you'll find the right spray type for every target group. Hansgrohe's spray researchers continue to find new spray types: from the matching flow to different shower angles and the right water pressure to the optimum spray form. Nothing is left to

chance in Hansgrohe's spray laboratory, so every customer's needs and requirements are met. With a little bit more in the way of comfort: because the user can move through the individual spray types simply at the touch of a button.

Croma® Select S Multi Hand shower



Easy to change the spray type at the touch of a button.



Intensive, pulsating and focused massage spray.

SoftRain

A soft water spray that caresses the body for that feel-good sensation.



IntenseRain

Intensive water spray that is perfect for rinsing out shampoo.



Massage

A concentrated jet with great refreshing effect.



Croma® Select S Vario Hand shower



Rain
Balanced spray for the daily shower and for rinsing hair.



IntenseRain
Intensive water spray that is perfect for rinsing out shampoo.



TurboRain
The strongest Rain spray, for a revitalising, refreshing shower pleasure.



Croma® Select S 1jet Hand shower



Rain
Balanced spray for the daily shower and for rinsing hair.



Technical details Croma® Select hand shower

		1jet	Vario	Multi
EU-Standard	Water consumption orientation by spray type	13-18l/min	9-16l/min	10-16l/min
	Fully functional from just	6.0l/min (0.2 bar at the shower)	7.5l/min (0.6 bar at the shower)	8.0l/min (0.7 bar at the shower)
EcoSmart 9l/min	Water consumption orientation by spray type	Max. 9.9l/min	Max. 9.9l/min	Max. 9.9l/min
	Fully functional from just	6.0l/min (0.7 bar at the shower)	7.5l/min (1.4 bar at the shower)	8.0l/min (1.1 bar at the shower)

Full benefits, drop by drop

Shower technology

QuickClean



The quick anti-limescale function for effortless cleaning: thanks to the flexible silicone jets, all you need to do is rub a finger over any dirt and limescale on the shower – and it's

gone. It's as easy as that! Hansgrohe's QuickClean technology guarantees that the shower spray always looks good, has a long lifetime and smooth function.



Your advantages

- Top-quality hard wearing silicone
- Fast and easy, saving time and prolonging the life of your showerhead
- Customers remain happy thanks to the long lifetime and functionality

EcoSmart



Thanks to a sophisticated flow limiter and special spray jets: EcoSmart showers consume up to 60% less water than other showers. This reduces water and energy costs. To find out just how much your project could save, visit

the savings calculator at **pro.hansgrohe-int.com/savings-calculator**

or mobile at

<http://m.pro.savings.hansgrohe-int.com>



Your advantages

- Up to 60% lower water consumption, therefore compliant with LEED requirements
- Lower energy requirement by saving hot water - therefore reduced CO₂ output and lower operating costs
- The right shower for any project thanks to the optimum combination of water savings and performance

How to control your pleasure

ShowerSelect® finish sets



Switch a function on and off? At the touch of a button. Change the spray types? Also at the touch of a button. Select technology will delight in your bathroom with this highly intuitive operating concept. Planning is safe and easy with these concealed products.

Your advantages

- Covers every application for 1 to 4 functions
- Also suitable for semi-public areas, since the thermal disinfection is easy and straightforward with the thermostat version
- Clear, minimalistic, precise shapes

Benefits for customers

- Easy to change the spray type
- Low-maintenance, low-wear technology
- Easy to operate, so less damage
- Cleaning is easier because there are fewer protruding handles and levers

ShowerSelect® Fixfit Porter

Thermostat for 2 functions with integrated hose connection and shower holder (unrestricted choice of hand shower and hose)



ShowerSelect® S

Mixer in a round design for 2 functions, e.g. connection of hand and overhead showers





▲
The ShowerSelect® range will enhance any bathroom with its ease of operation, which also makes it ideal for refurbishments and modernisations.

▼
The flushmount buttons create a completely level surface that is really easy to clean.

▲
The Select buttons facilitate intuitive and easy operation – even with limited freedom of movement.



One for all

iBox® universal

Ever since it was first introduced in 2001, the iBox universal has been the first and only basic set for all Hansgrohe and Axor manual and thermostatic concealed shower solutions. Their features are just as many and varied as the number of possible uses. The iBox universal

creates more space, freedom of movement and planning freedom in the bathroom. As a veritable all-rounder, it is designed to go with any standard installation system, connection and fitting. It offers unique advantages that really pay in bathroom planning.



◀ **Concealed installation:** the basic set disappears completely into the wall. Mixer and thermostat finish sets and overhead showers with several sprays from various series can be fitted to it.



Over the long term: the basic set is retained when the bathroom is refurbished. The functions block and finish set are easy to replace.

Your advantages

- The iBox universal offers a high level of flexibility and lots of design options
- Your project planning will be much easier: one basic set is sufficient for any and every solution – leaving you with more time to choose the mixer
- The iBox universal is suitable for use in private or public facilities, and complies with all the main international standards
- A concealed system that has been proven millions of times over – and on which you can rely
- Includes a flush block so the pipes can be flushed through easily
- For various wall thicknesses and prefabricated bathrooms

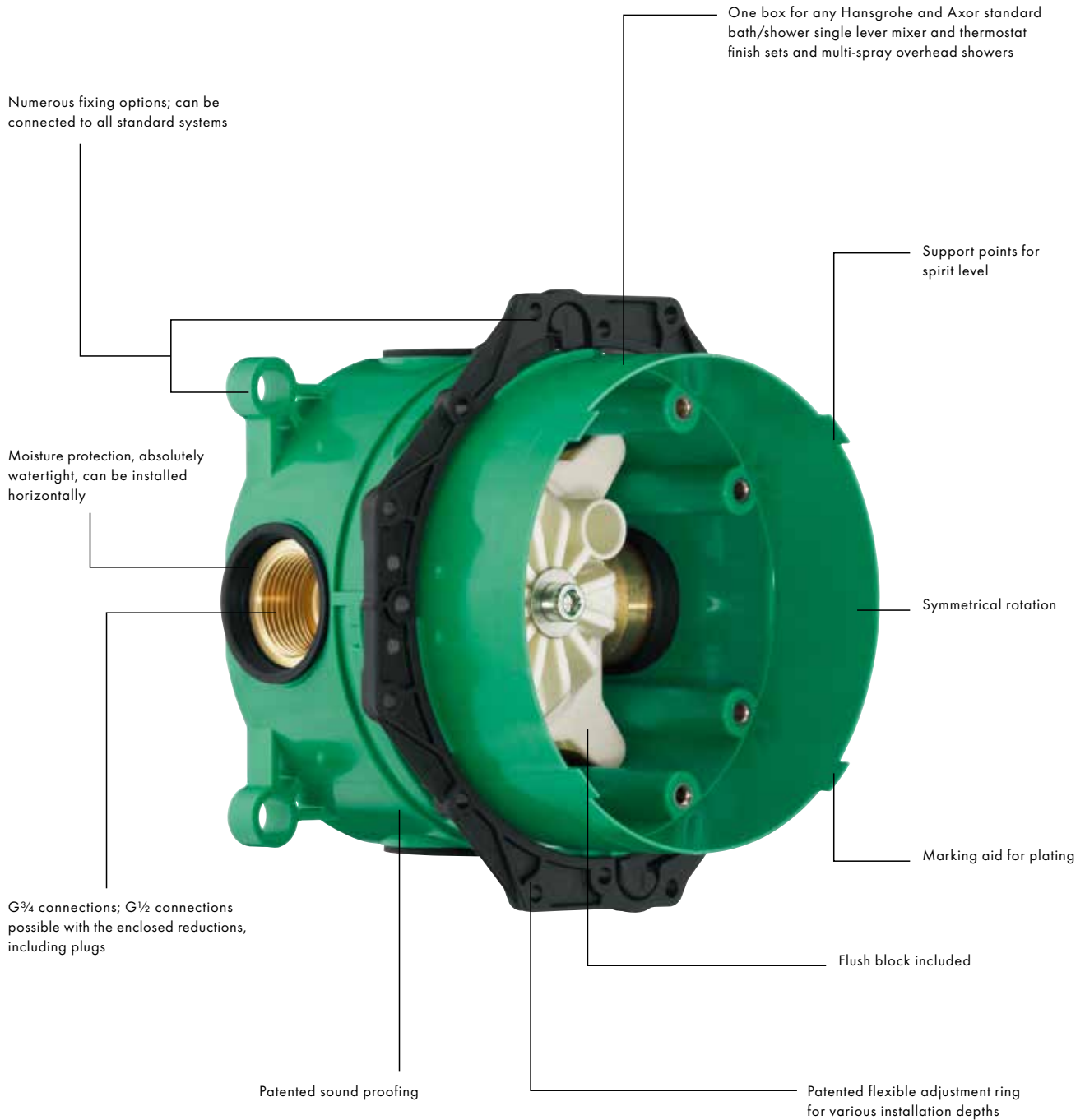

Range Logis®

Basin



Logis® 70



Logis® 100

Single lever basin mixer

- # 71070, -000 with waste set
- # 71071, -000 without waste set
- # 71077, -000 with Push-Open waste
- # 71072, -000 with CoolStart with waste
- # 71073, -000 with Coolstart without waste
- # 71074, -000 unpressurised
- # 71078, -000 LowFlow with waste set
- # 71075, -000 with 2 flow rates with waste
- # 71076, -000 with 2 flow rates without waste

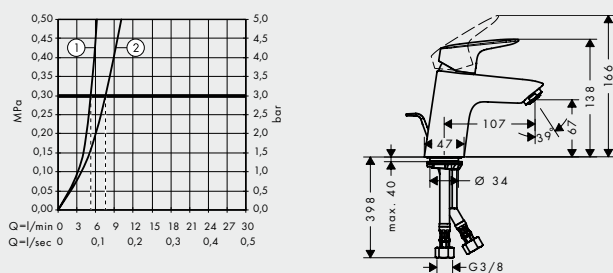

Legend

- ① With flow limiter
- ② Without flow limiter

Single lever basin mixer

- # 71100, -000 with waste set
- # 71101, -000 without waste set
- # 71107, -000 with Push-Open waste
- # 71102, -000 with CoolStart with waste
- # 71103, -000 with Coolstart without waste
- # 71104, -000 LowFlow with waste set

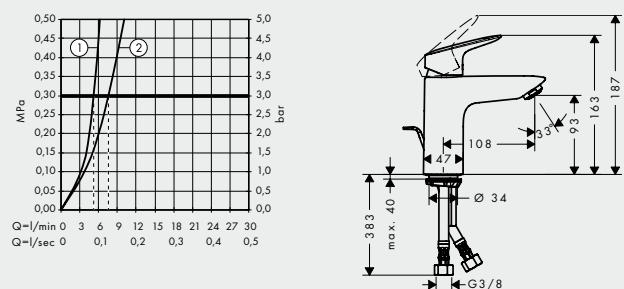

Legend

- ① With flow limiter
- ② Without flow limiter





Logis® 190

Single lever basin mixer

- # 71090, -000 with waste set
- # 71091, -000 without waste set
- # 71095, -000 with 2 flow rates with waste

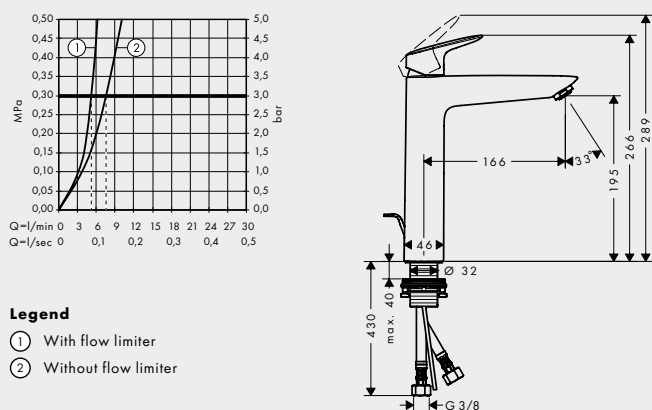

Logis® 210

Single lever basin mixer, swivel spout 120°

- # 71130, -000 with waste set
- # 71131, -000 without waste set

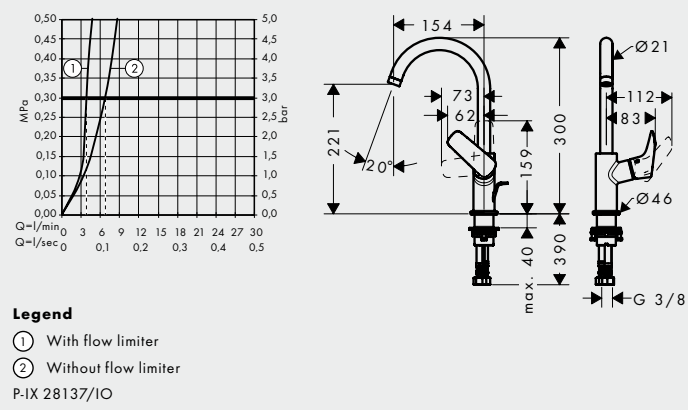

Range Logis®

Basin



Logis®

3-hole basin mixer
71133, -000 with waste set



Logis®

2-hole basin mixer wall-mounted
71220, -000

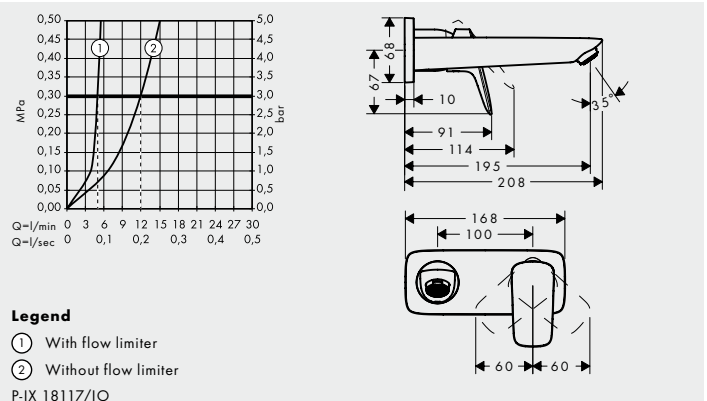
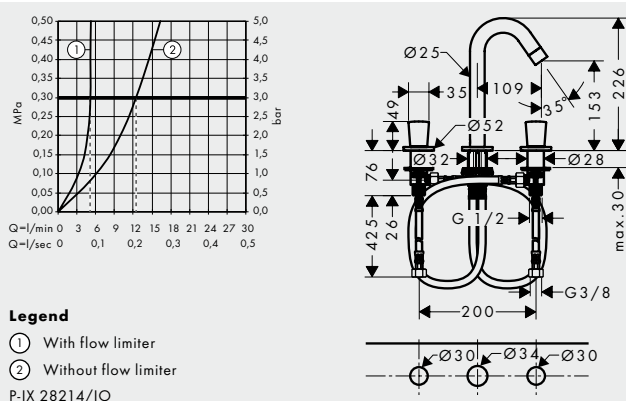



Range Logis®

Basin



Logis®

2-handle basin mixer

71222, -000 with waste set
71221, -000 without waste set



Logis® 70

Pillar tap for small wash basins

71120, -000 without waste set

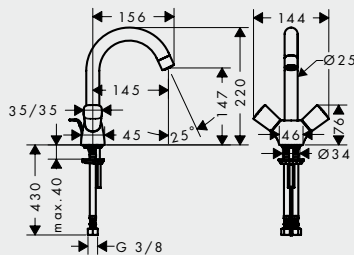
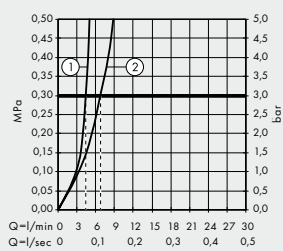

Legend

- ① With flow limiter
 - ② Without flow limiter
- P-IX 28135/IO

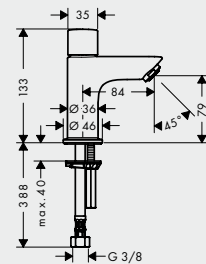
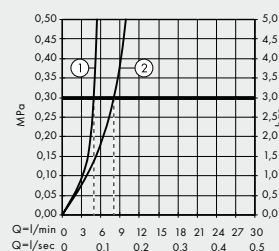

Legend

- ① With flow limiter
 - ② Without flow limiter
- P-IX 28140/IO



Bidet



Logis® 70

Single lever bidet mixer

#71204, -000 with waste set

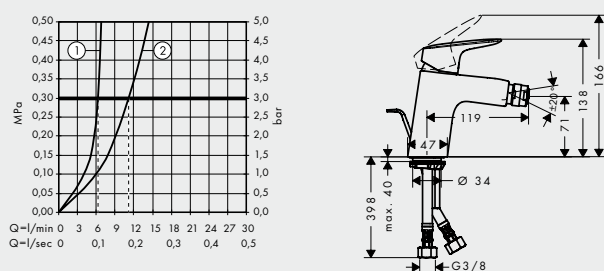

Legend

- ① With flow limiter
- ② Without flow limiter



Logis® 100

Single lever bidet mixer

#71200, -000 with waste set

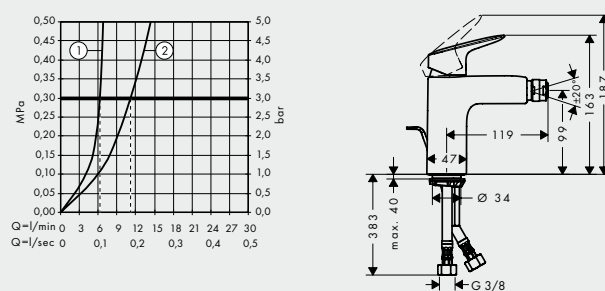

Legend

- ① With flow limiter
- ② Without flow limiter

P-IX 28139/IO



Range Logis®

Bath



Logis®

Single lever bath mixer

71405, -000 concealed
01800180 basic set iBox universal

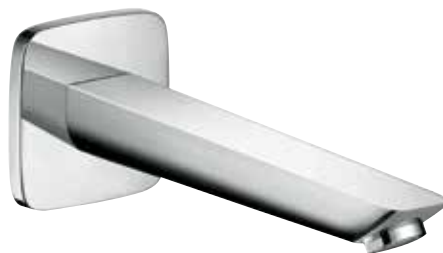

Logis®

Bath spout

71410, -000 exposed

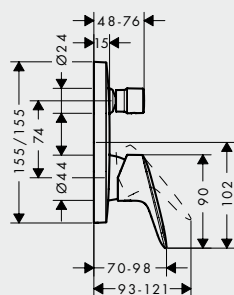
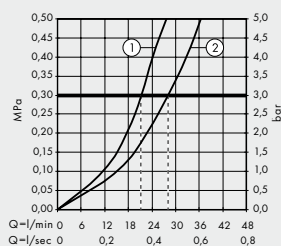

- Legend**
- ① Outlet shower
 - ② Outlet bath

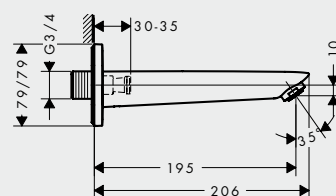
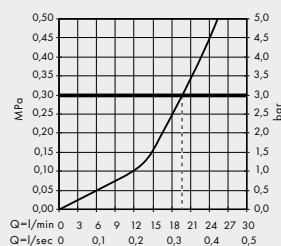



Logis®

Single lever bath mixer

71400, -000 exposed

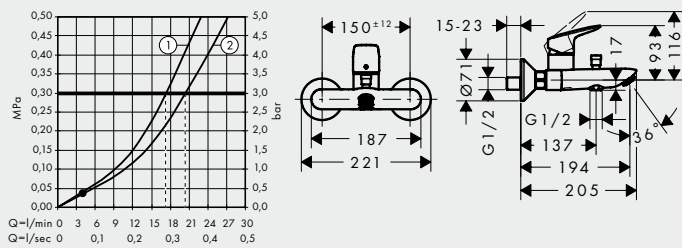

Legend

- ① Outlet shower with IB resistance
 - ② Outlet bath
- PA-IX 28116/ICB



Logis®

3-hole bath mixer for installation on the tub rim

71300, -000 concealed

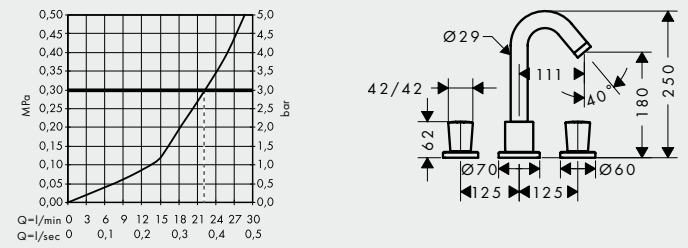

Legend

- ① With flow limiter
- ② Without flow limiter



Range Logis®

Bath



Logis®

3-hole bath mixer for installation on the tub rim

71310, -000
13437180 basic set

Shower



Logis®

Single lever shower mixer

71605, -000 concealed
01800180 basic set iBox universal

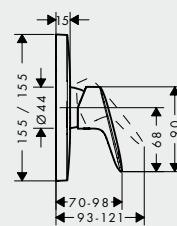
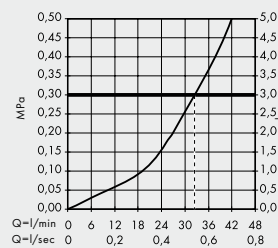
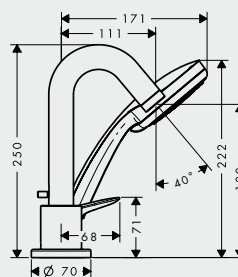
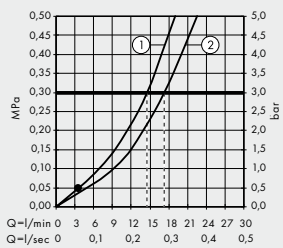

Legend

- ① Hand shower
 - ② Bath spout
- PA-IX 19706/ICB





Logis®

Single lever shower mixer

71600, -000 exposed



Logis®

Shut-off valve

71970, -000
 # 15973180 basic set for 80 l/min
 # 15974180 basic set for 40 l/min
 # 15970180 basic set for 130 l/min

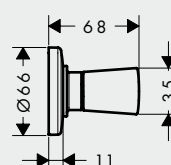
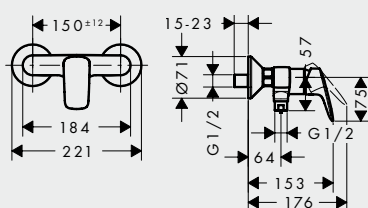
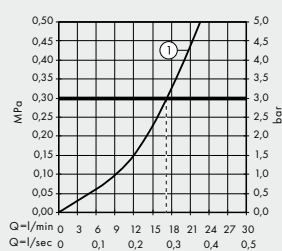

Legend

① Outlet shower with IB-resistance
 PA-IX 28114/IB

Range

Croma[®] Select



Croma[®] Select S Multi

Hand shower

26800, -400 (16 l/min)
26801, -400 (9 l/min) EcoSmart



Croma[®] Select S Vario

Hand shower

26802, -400 (15 l/min)
26803, -400 (9 l/min) EcoSmart

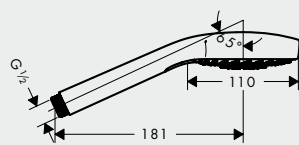
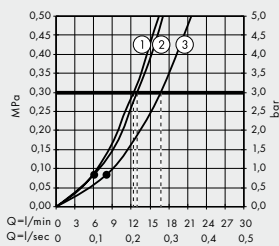

16 l/min

Legend

- ① Massage
- ② IntenseRain
- ③ SoftRain

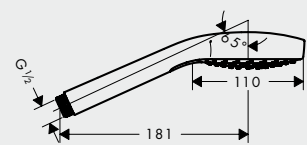
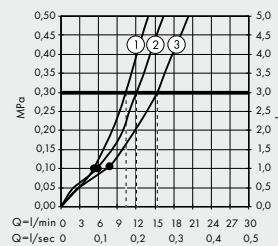

15 l/min

Legend

- ① TurboRain
- ② IntenseRain
- ③ Rain





Croma® Select S 1jet

Hand shower

- # 26804, -400 (16 l/min)
- # 26805, -400 (9 l/min) EcoSmart
- # 26806, -400 (7 l/min) EcoSmart

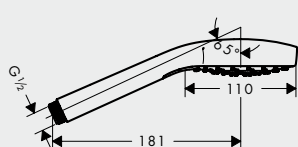
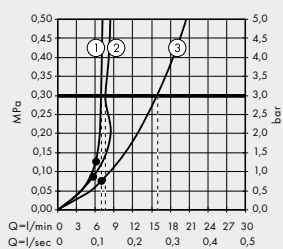

Legend

- ① # 26806, -400 Eco Smart (7 l/min)
- ② # 26805, -400 Eco Smart (9 l/min)
- ③ # 26804, -400 1jet (16 l/min)



Croma® Select S Porter Sets

Croma® Select S 1jet

- # 26420, -400 hose length 1.25 m
- # 26410, -400 hose length 1.60 m

Croma® Select S Vario

- # 26421, -400 hose length 1.25 m (not shown)
- # 26411, -400 hose length 1.60 m (not shown)

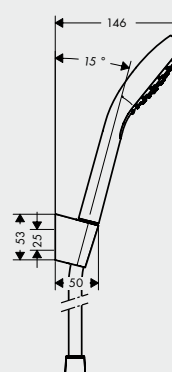
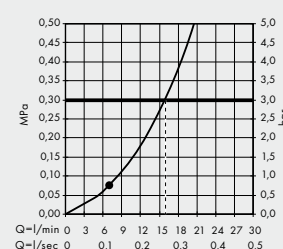

Range

Croma® Select



Croma® Select E Multi

Hand shower

26810, -400 (16 l/min)
26811, -400 (9 l/min) EcoSmart



Croma® Select E Vario

Hand shower

26812, -400 (15 l/min)
26813, -400 (9 l/min) EcoSmart

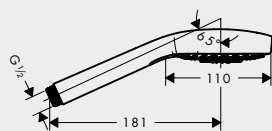
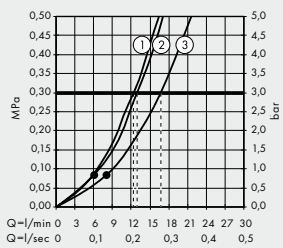

16 l/min

Legend

- ① Massage
- ② IntenseRain
- ③ SoftRain

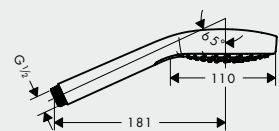
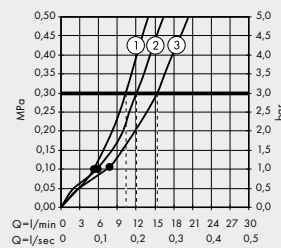

15 l/min

Legend

- ① TurboRain
- ② IntenseRain
- ③ Rain





Croma® Select E 1jet

Hand shower

- # 26814, -400 (16l/min)
- # 26815, -400 (9l/min) EcoSmart
- # 26816, -400 (7l/min) EcoSmart

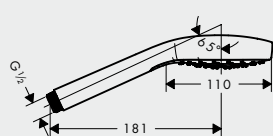
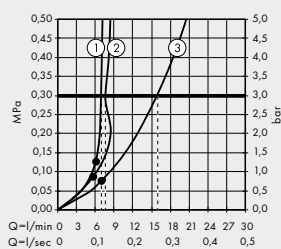

Legend

- ① # 26816, -400 Eco Smart (7l/min)
- ② # 26815, -400 Eco Smart (9l/min)
- ③ # 26814, -400 1jet (16l/min)



Croma® Select E Porter Sets

Croma® Select E 1jet

- # 26424, -400 hose length 1.25 m
- # 26412, -400 hose length 1.60 m

Croma® Select E Vario

- # 26425, -400 hose length 1.25 m (not shown)
- # 26413, -400 hose length 1.60 m (not shown)

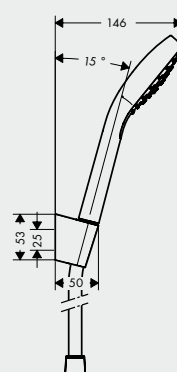
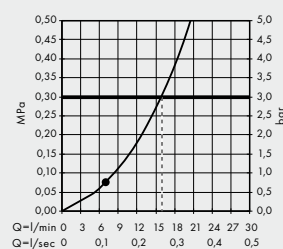

Range

Croma® Select



Croma® Select S Multi

Croma® Select S Vario

Croma® Select S 1jet

Shower set

- # 26570, -400 0.90 m
- # 26571, -400 0.90 m EcoSmart
- # 26560, -400 0.65 m (not shown)
- # 26561, -400 0.65 m EcoSmart (not shown)

Shower set

- # 26572, -400 0.90 m
- # 26573, -400 0.90 m EcoSmart
- # 26562, -400 0.65 m (not shown)
- # 26563, -400 0.65 m EcoSmart (not shown)

Shower set

- # 26574, -400 0.90 m
- # 26575, -400 0.90 m EcoSmart
- # 26564, -400 0.65 m (not shown)
- # 26565, -400 0.65 m EcoSmart (not shown)

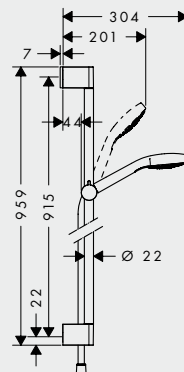
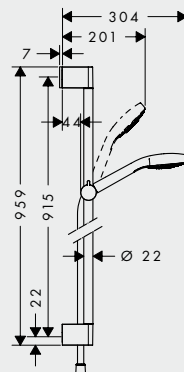
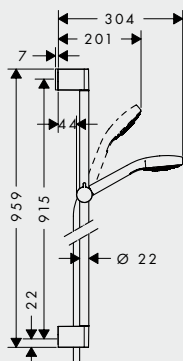

Flow rate diagram
see hand showers
page 56





Croma® Select E Multi

Shower set

- # 26580, -400 0.65 m
- # 26581, -400 0.65 m EcoSmart
- # 26590, -400 0.90 m (not shown)
- # 26591, -400 0.90 m EcoSmart (not shown)

Croma® Select E Vario

Shower set

- # 26582, -400 0.65 m
- # 26583, -400 0.65 m EcoSmart
- # 26592, -400 0.90 m (not shown)
- # 26593, -400 0.90 m EcoSmart (not shown)

Croma® Select E Ijet

Shower set

- # 26584, -400 0,65 m
- # 26585, -400 0,65 m EcoSmart
- # 26594, -400 0,90 m (not shown)
- # 26595, -400 0,90 m EcoSmart (not shown)

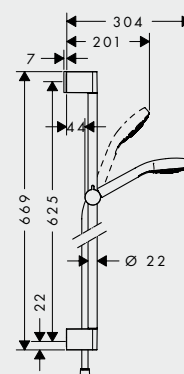
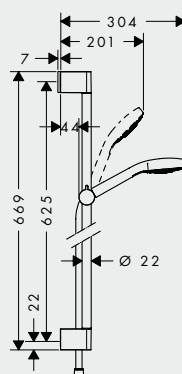
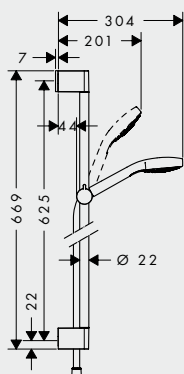

Range

Croma® Select



Croma® Select S Vario

Combi Set

Shower set with Ecostat Comfort thermostat
 # 27014, -400 0.90 m
 # 27013, -400 0.65 m (not shown)



Croma® Select E Vario

Combi Set

Shower set with Ecostat Comfort thermostat
 # 27082, -400 0.90 m
 # 27081, -400 0.65 m (not shown)

Flow rate diagram
 see hand showers
 page 56

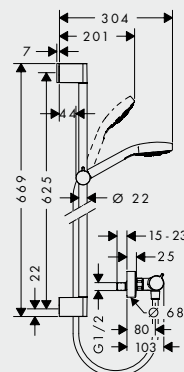
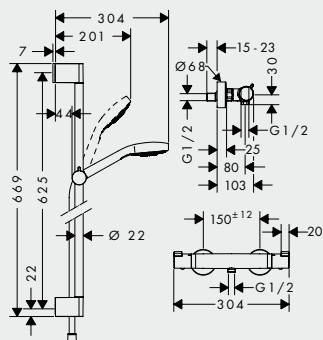

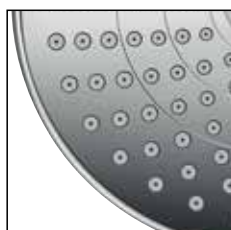

▲ Surface chrome

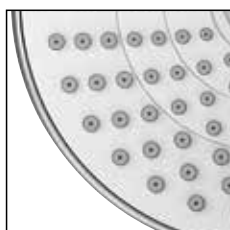

▲ Surface white/Chrome



Croma® Select S 180 2jet

Overhead shower

Rain/IntenseRain: 17 l/min
 # 26522, -000, -400
 # 26523, -000, -400 (9 l/min) EcoSmart
 # 27413, -000 optional shower arm 389 mm
 # 27479, -000 optional ceiling connection 100 mm

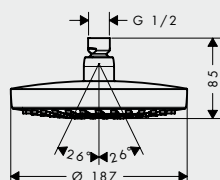
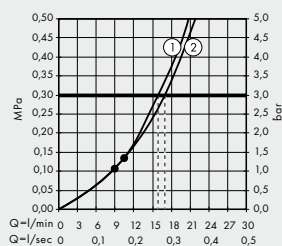

- Legend**
- ① IntenseRain
 - ③ Rain



Croma® Select E 180 2jet

Overhead shower

Rain/IntenseRain: 17 l/min
 # 26524, -000, -400
 # 26528, -000, -400 (9 l/min) EcoSmart
 # 27446, -000 optional shower arm 389 mm
 # 27467, -000 optional ceiling connection 100 mm

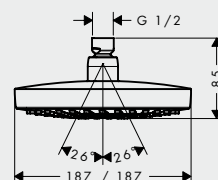
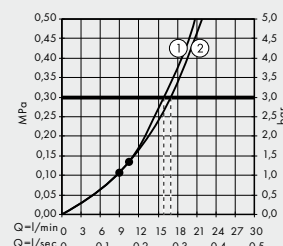

- Legend**
- ① IntenseRain
 - ③ Rain



Range Croma® Select



Croma® Select S 180 2jet

Showerpipe

with swivelling Croma Select S 180 2jet overhead shower Rain/IntenseRain (16 l/min), Croma Select S Multi hand shower (13 l/min) and EcoStat Comfort thermostat, shower arm 400 mm
27253, -400
27254,-400 (9 l/min) EcoSmart



Croma® Select S 180 2jet

Showerpipe

with swivelling Croma Select S 180 2jet overhead shower Rain/IntenseRain (16 l/min), Croma Select S Multi hand shower (13 l/min) and single lever mixer, shower arm 400 mm
27255, -400

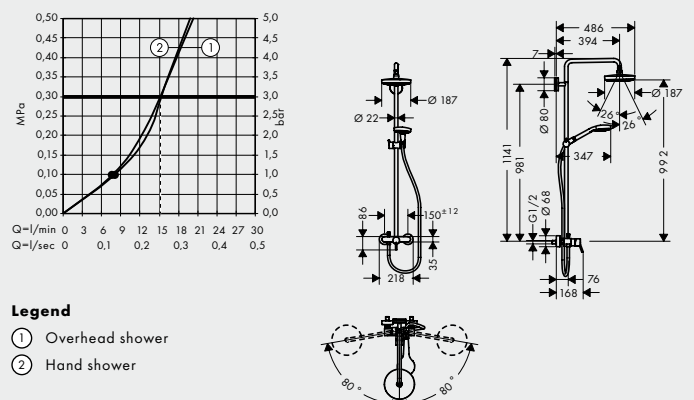
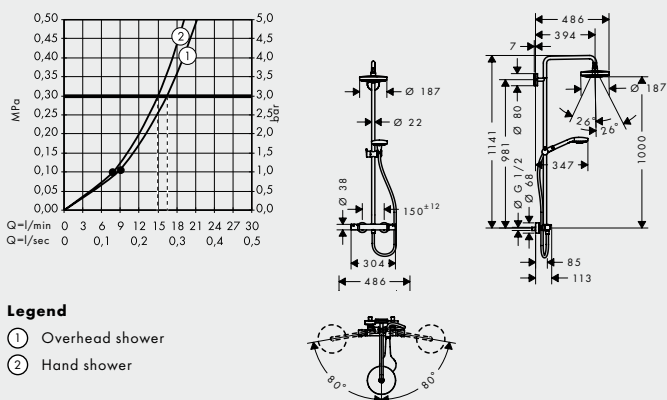



Croma® Select E 180 2jet

Croma Select E 180 2jet

Showerpipe

with swivelling Croma Select E 180 2jet overhead shower Rain/IntenseRain (16l/min), Croma Select E Multi hand shower (13l/min) and Ecostat Comfort thermostat, shower arm 400 mm # 27256, -400 # 27257, -400 (9l/min) EcoSmart

Showerpipe

with swivelling Croma Select E 180 2jet overhead shower Rain/IntenseRain (16l/min), Croma Select E Multi hand shower (13l/min) and single lever mixer, shower arm 400 mm # 27258, -400

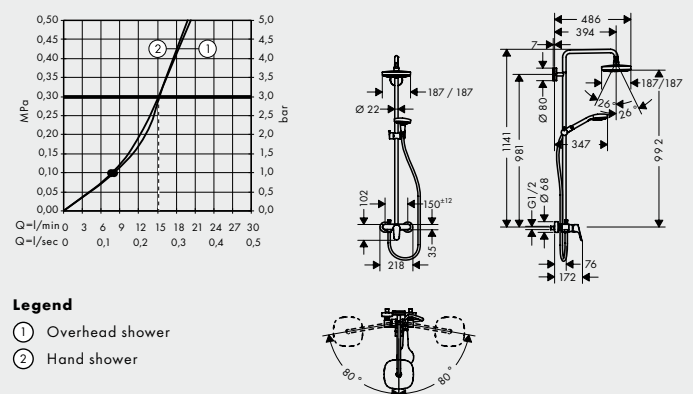
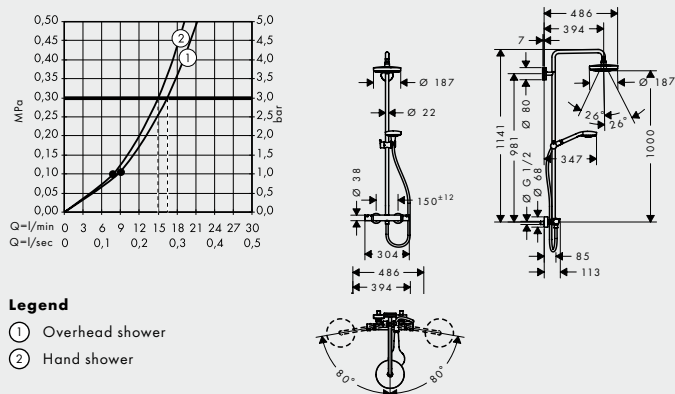

Range

Crometta® 100



Crometta® 100 Multi

Hand shower

26823, -400 (19 l/min)
26826, -400 (9 l/min) EcoSmart

Crometta® 100 Vario

Hand shower

26824, -400 (18 l/min)
26827, -400 (9 l/min) EcoSmart

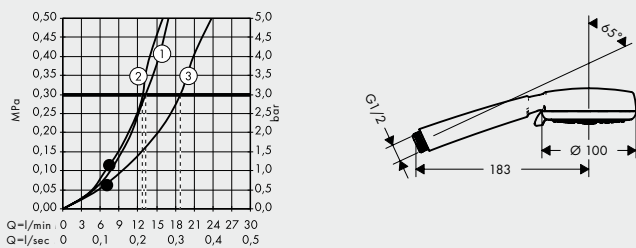

Legend

- ① TurboRain
- ② Massage
- ③ Rain

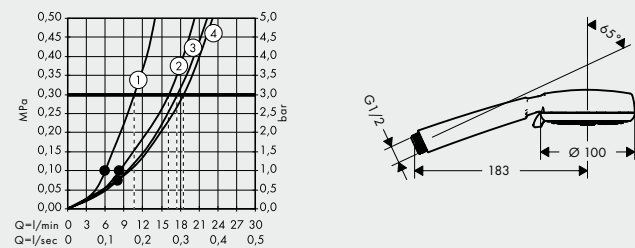

Legend

- ① Massage
- ② Shampoo
- ③ Normal
- ④ Rain





Crometta® 100 1jet

Hand shower

- # 26825, -400 (16 l/min)
- # 26828, -400 (9 l/min) EcoSmart
- # 26829, -400 (7 l/min) EcoSmart

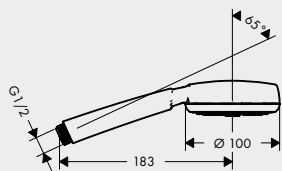
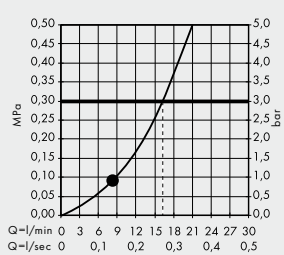

Crometta® 100 Porter Sets

Crometta® 100 1jet

- # 26664, -400 hose length 1.25 m
- # 26665, -400 hose length 1.60 m

Crometta® 100 Vario

- # 26666, -400 hose length 1.25 m
- # 26667, -400 hose length 1.60 m

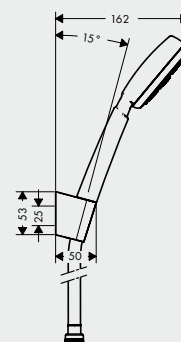
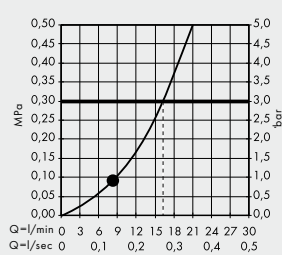

Range

Crometta® 100



Crometta® 100 Multi



Crometta® 100 Vario



Crometta® 100 1jet

Shower set

- # 26656, -400 0.90 m
- # 26659, -400 0.90 m (9l/min) EcoSmart
- # 26650, -400 0.65 m (not shown)
- # 26653, -400 0.65 m (9l/min) EcoSmart (not shown)

Shower set

- # 26657, -400 0.90 m
- # 26662, -400 0.90 m (9l/min) EcoSmart
- # 26651, -400 0.65 m (not shown)
- # 26654, -400 0.65 m (9l/min) EcoSmart (not shown)

Shower set

- # 26658, -400 0.90 m
- # 26663, -400 0.90 m (9l/min) EcoSmart
- # 26652, -400 0.65 m (not shown)
- # 26655, -400 0.65 m (9l/min) EcoSmart (not shown)

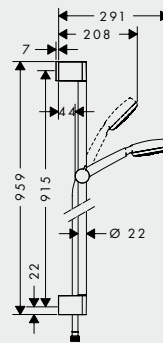
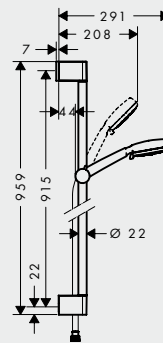
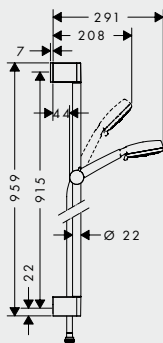

Flow rate diagram
see hand showers
page 64





Crometta® 100 Vario



▲ Surface chrome

▲ Surface white/chrome



Crometta® 160

Combi Set

Shower set with Ecostat Universal thermostat
 # 27031, -400 0,90 m
 # 27030, -400 0,65 m (not shown)

Overhead shower

(17l/min)
 # 26577, -000, -400
 # 26578, -000, -400 (9l/min) EcoSmart
 # 26576, -000, -400 LowPressure (from 0.2 bar)
 # 27412, -000 optional shower arm 230 mm
 # 27479, -000 optional ceiling connection 100 mm

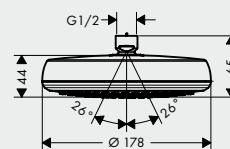
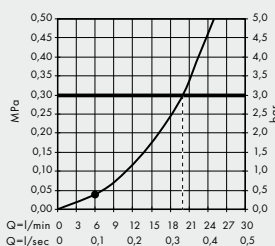
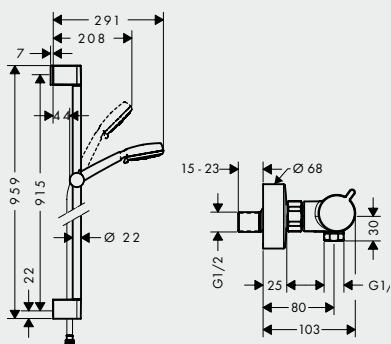

Range

Crometta® 100



Crometta® 160 1jet



Crometta® 160 1jet

Showerpipe

with Crometta 160 overhead shower (17l/min),
Crometta 100 Vario hand shower
and Ecostat Universal thermostat
27264, -400
27265, -400 (9l/min) EcoSmart

Showerpipe

with Crometta 160 overhead shower (16l/min),
Crometta 100 Vario hand shower
and single lever mixer
27266, -400

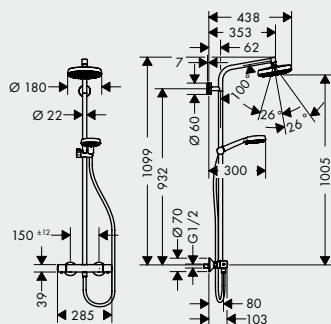
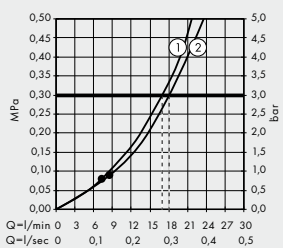

- Legend**
- ① Hand shower
 - ② Overhead shower

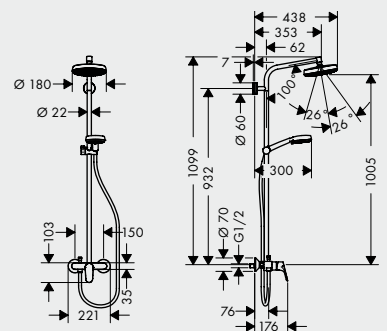
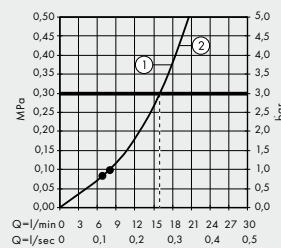

- Legend**
- ① Hand shower
 - ② Overhead shower



Range Ecostat®



Ecostat® S/Ecostat® E

Ecostat® S/Ecostat® E

Thermostat for 2 functions

15758, -000 Ecostat S

15708, -000 Ecostat E

Thermostat for 1 function (not shown)

15757, -000 Ecostat S

15707, -000 Ecostat E

Thermostat Highflow

15756, -000 Ecostat S

15706, -000 Ecostat E

Thermostat (not shown)

15755, -000 Ecostat S

15705, -000 Ecostat E

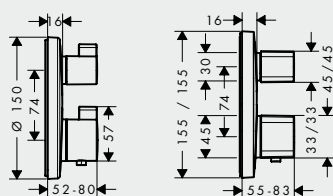
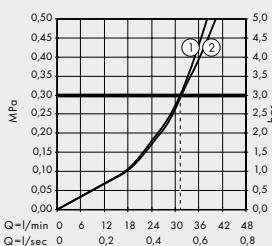

All flow rates without functions

Legend

① Bottom

② Above

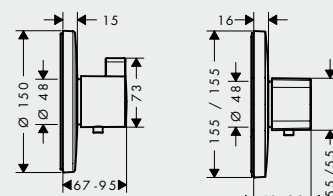
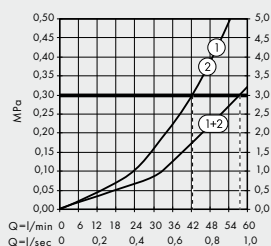

All flow rates without functions

Legend

① Bottom

② Above

Range ShowerSelect®



ShowerSelect® S/ShowerSelect®



ShowerSelect® S/ShowerSelect®

Thermostat for 1 function

- # 15744, -000 ShowerSelect® S
- # 15762, -000 ShowerSelect®

Thermostat for 2 functions

- # 15743, -000 ShowerSelect® S
- # 15763, -000 ShowerSelect®

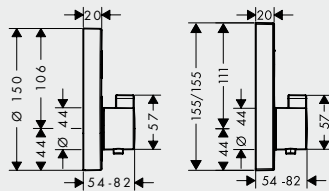
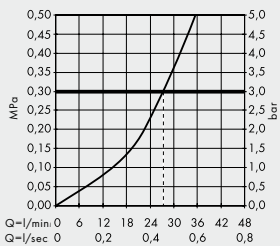

All flow rates without functions

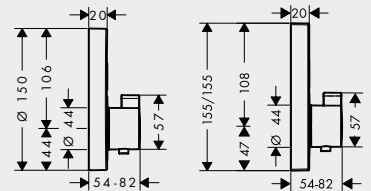
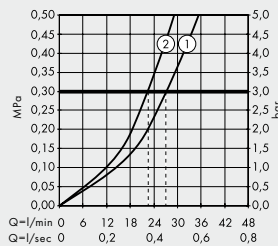

All flow rates without functions

Legend

- ① Bottom
- ② Above





ShowerSelect®



ShowerSelect® S/ShowerSelect®

Thermostat for 2 functions

with integrated hose connection and Porter
 (hand shower and shower hose can be chosen freely)
 # 15765, -000

Thermostat Highflow

15741, -000 ShowerSelect® S
 # 15760, -000 ShowerSelect®

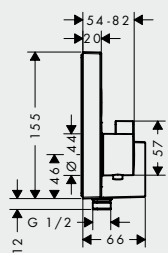
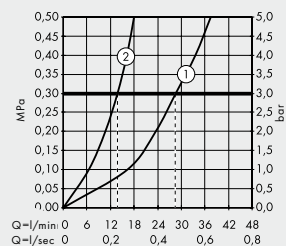

All flow rates without functions

Legend

- ① Bottom
- ② Above

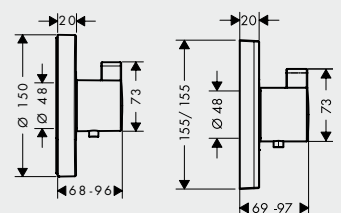
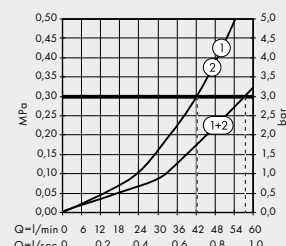

All flow rates without functions

Legend

- ① Bottom
- ② Above



Range ShowerSelect®



ShowerSelect® S/ShowerSelect®



ShowerSelect® S/ShowerSelect®

Thermostat Highflow for 1 function (bottom) and 1 additional function (above)

15742, -000 ShowerSelect® S
15761, -000 ShowerSelect®

Valve for 3 functions

15745, -000 ShowerSelect® S
15764, -000 ShowerSelect®

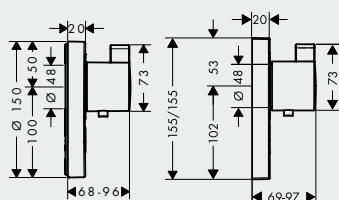
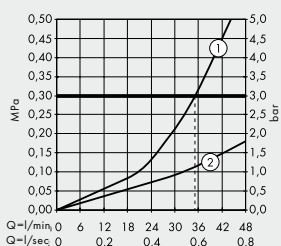

All flow rates without functions

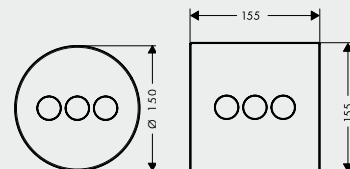
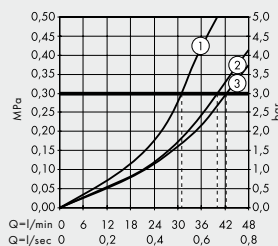

All flow rates without functions

Legend

- ① Outlet 1
- ② Outlet 2
- ③ Outlet 3





ShowerSelect® S/ShowerSelect®

ShowerSelect® S/ShowerSelect®

Mixer for 1 function
 # 15747, -000 ShowerSelect® S
 # 15767, -000 ShowerSelect®

Mixer for 2 functions
 # 15748, -000 ShowerSelect® S
 # 15768, -000 ShowerSelect®

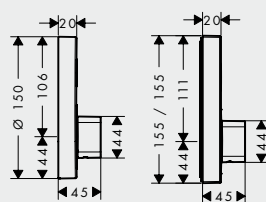
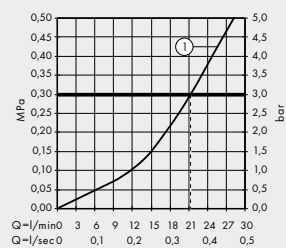

All flow rates without functions

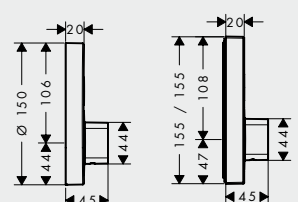
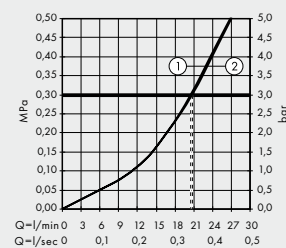

All flow rates without functions

- Legend**
- ① Bottom
 - ② Above



Accessories

Logis®



Lotion dispenser
Glass
40514, -000



Toothbrush tumbler
Glass
40518, -000



Soap dish
Glass
40515, -000



Single hook
40511, -000



Roll holder
40523, -000



Roll holder
without cover
40526, -000



Spare roll holder
40517, -000



Toilet brush tumbler
Glass
40522, -000

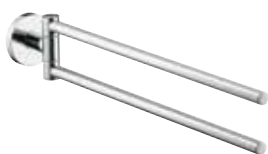

Towel holder
2-handle
40512, -000



Grab bar
300 mm
40513, -000



Bath towel rail
600 mm
40516, -000

Hansgrohe

Technologies and spray modes

Technologies



Switches over to a different shower or spray type in moments, and provides pleasure at the touch of a button.



Reduces the flow rate to save water and energy. For long-lasting pleasure.

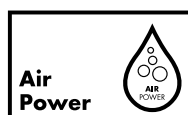

Combines water with a generous amount of air. For a soft, splash-free water spray and rich, full shower drops



Limescale deposits are simply wiped away by rubbing a finger over the flexible silicone jets.



Defines the individually utilisable area between washstand and mixer. Something to suit every customer.

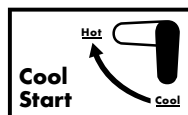

Cold water start to flow when it is opened in the basic setting. You consume hot water only when you need it.

Spray modes



Balanced spray for the daily shower.



Intense water spray, perfect for rinsing out shampoo.



A soft water spray that caresses the body for that feel-good sensation.



The strongest Rain spray, for revitalising, refreshing shower pleasure.



Strong, pulsating massage spray.

Surfaces

Order numbers specifying a surface finish are (#) eight digits long, for example 28500, -000 = Chrome

-000 Chrome
-400 White/Chrome



The new Logis mixer range and new Croma Select shower series offer you a complete range with products that appeal technically, optically and financially. And bathroom solutions that impress on every level.

We did our utmost to ensure that the printing of this brochure was friendly to the environment. You too can contribute to the protection of our environment by passing on the brochure to others when you've finished reading it, or by recycling it.

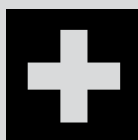
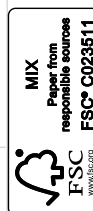

PartnerPlus services

- Headquarters** – Hansgrohe SE · Postbox 1145 · D-77757 Schiltach
Tel. +49 78 36 51-0 · Fax +49 78 36 51-13 00 · info@hansgrohe.com · www.hansgrohe-int.com
- Australia** – Hansgrohe Pty Ltd · Level 1, 123 Camberwell Rd, East Hawthorn · 3123 Victoria
Tel. +61 3 9811 9971 · Fax +61 3 9804 0042 · info@hansgrohe.com.au · www.hansgrohe.com.au
- Cyprus** – Hansgrohe Middle East & Africa Limited · Pentadaktilou Street 2 · Office 104
CY-7101 Larnaca (Aradippou) · Tel. +357 24 813081 · Fax +357 24 813031
me.support@hansgrohe.com · www.hansgrohe-middleeast.com
- Denmark** – Hansgrohe · Jegstrupvej 6 · DK-8361 Hasselager · Telefon +45 86 287400
Telefax +45 86 287401 · info@hansgrohe.dk · www.hansgrohe.dk
- Estonia** – Hansgrohe Eesti esindaja Andrus Asavi · Mäealuse 2/1 · 12618 Tallinn
Tel. +372 53 32 92 55 · Fax +372 56 00 00 55 · info@hansgrohe.ee · www.hansgrohe.ee
- Kazakhstan** – Hansgrohe · Алматы · Бостандықский район · «Микрорайон КЕРЕМЕТ»,
дом № 1, часть А3 · телефон +7 (727) 315-09-16 · факс: +7 (727) 315-09-17
info@hansgrohe.kz · www.hansgrohe.kz
- Latvia** – Hansgrohe Latvijas pārstāvniecība · SIA Aqua Studio · Raiņa iela 14 · LV-3913 Iecava
Tel. +371 29 22 90 29 · Fax +371 63 94 22 51 · info@hansgrohe.lv · www.hansgrohe.lv
- Lithuania** – Santoza · Ulonų g. 5 · LT-08240 Vilnius
Tel. +370 5 2043291 · Fax +370 5 2043293 · info@hansgrohe.lt · www.hansgrohe.lt
- Norway** – Hansgrohe A/S · Jegstrupvej 6 · DK-8361 Hasselager · Tel. +47 32 79 54 00
Fax +45 86 287401 · info@hansgrohe.no · www.hansgrohe.no
- Portugal** – Hansgrohe · Showroom: Rua Antoine de Saint Exupéry Alapraia · P-2765-043 Estoril
Tel. +351 21 4667110 · Fax +351 21 4667119 · hansgrohe@jrbotas.com
www.hansgrohe-int.com · www.pro.hansgrohe-int.com
- Sweden** – Hansgrohe AB · Svagatan 2B · 416 68 Göteborg
Tel. +46 31 216600 · Fax +46 31 190103 · info@hansgrohe.se · www.hansgrohe.se

