

Hansgrohe
Memo to the trade

Planning and installation

Overhead showers and shower systems





Table of contents

| | |
|----|--|
| 4 | Hansgrohe for Professionals |
| 8 | System 1: 1-spray showers – Like showering in rain Raindance® overhead showers for ceiling and wall installation |
| 12 | System 2: 2-spray overhead showers – Stylish and ergonomic Raindance® Rainfall 180 2jet and Raindance E 420 2jet for installation on the wall |
| 16 | System 3: 3-spray overhead showers – Variety for body and soul Raindance® Rainfall® 3jet for wall installation and Raindance® Rainmaker® for installation flush with the ceiling |
| 32 | System 4: Showerpipes – The simple way to intense shower pleasure Raindance® Showerpipes for exposed and concealed installation for showers or bath tubs. Raindance® Connect Showerpipe for mounting onto existing mixers. |
| 38 | iBox® universal – The simple solution for concealed installation Possible combinations and brief installation instructions |
| 40 | Hansgrohe and Axor finish sets – Combinations and product lines Thermostats, shut-off and diverter valves |
| 44 | RainBrain® – The intelligent shower control Electronic control unit with touch-screen function Planning and installation instructions |

Hansgrohe for Professionals

We are partners

Hansgrohe supports the professional partners through a wide range of services.

Make sure to benefit from our comprehensive knowledge.

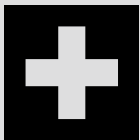

Find out more on our website:
pro.hansgrohe-int.com



Hansgrohe for
Professionals
Shower technology

Innovations for extraordinary shower pleasure

Showering is much more than just a question of hygiene. With Hansgrohe shower systems, it becomes an experience. Our overhead showers and shower systems combine design excellence with technologies that make our products the most innovative on the market. This brochure offers you all the relevant information for the planning and installation of the shower systems presented here.

Ground-breaking Hansgrohe shower technologies – greater shower pleasure for your customers



AirPower: Our AIR technology mixes water with air, just as in nature. This not only creates the effect of a rain shower, but also reduces water consumption. At the same time, the volume of water in the shower seems much greater.



QuickClean: No more limescale or other deposits: our QuickClean surfaces can be cleaned with a simple rubbing motion. This prevents the jets from clogging up, and keeps the showers looking like new – for years to come.



ComfortZone: Our trend-setting ergonomic concept permits comfortable operation of the mixers, while protecting against extreme temperatures.



XXL Performance: Hansgrohe started the trend towards larger showers. We were one of the first manufacturers to introduce extra-large showers with excellent spray quality that offer extraordinary shower pleasure.



EcoSmart: The innovative combination of flow limitation, special spray jets, and the mixture of water and air reduces the water consumption of showers and basin mixers.

In this brochure, EcoSmart versions are marked with a drop symbol.



Shower pleasure has many faces

The Hansgrohe world of shower systems offers the perfect solution for each of your customers: from Showerpipes as a simple exposed installation (ideal for quick bathroom renovations) to overhead showers with one, two or three spray modes or an extra-large spray surface, all the way to high-end installations with additional invigorating side showers.

In this brochure you will find all the necessary technical information for working with shower systems: measurements, flow rate charts, planning and installation instructions as well as useful tips from our technicians.



1-spray shower systems; Example: Raindance® S 240 AIR overhead shower with Raindance® S 100 AIR 3jet hand shower, page 8–11



2-spray shower systems; Example: Raindance® E 420 AIR 2jet overhead shower with PuraVida® 150 3jet hand shower, page 12–15



Product variations



3-spray shower systems; Example: Raindance® Rainfall® 3jet overhead shower with Raindance® S 100 AIR 3jet hand shower, page 16–29



3-spray shower systems; Example: Raindance® Rainmaker® AIR overhead shower with Raindance® S 150 AIR 3jet hand shower, page 16–29



3-spray shower systems with side showers; Example: Raindance® Rainmaker® with Raindance® S 150 AIR 3jet hand shower, page 30–31



Shower systems for exposed installation, ideal for renovation purposes; Example: Raindance® Showerpipe 240, page 32–37





System 1: 1-spray overhead showers

Like showering in rain: Raindance AIR plate overhead showers release a particularly lavish spray of water that feels just like a natural rain shower. They are available in different versions: as a super-slim model, in the Style version or with a more elaborate appearance in the Classic version. The 1-spray shower range is available in diameters of 180 to 350 mm for ceiling or wall installation. The rectangular E-models are available up to a width of 420 mm. A truly royal experience is promised by the Raindance AIR Royale. Made from solid metal and crafted by expert hands, it offers you an incredible diameter of 350 mm.

Raindance® S 180 AIR overhead shower

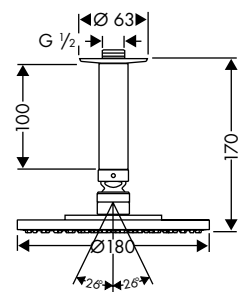

Raindance® S 240 AIR overhead shower

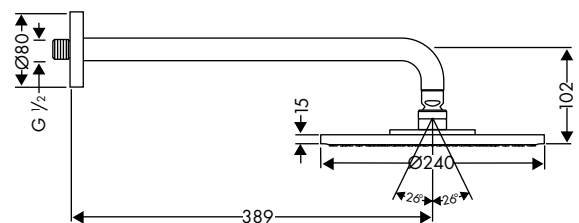

Raindance® S 300 AIR overhead shower

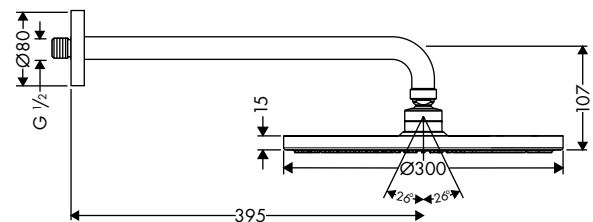

Raindance® Royale S 350 AIR overhead shower

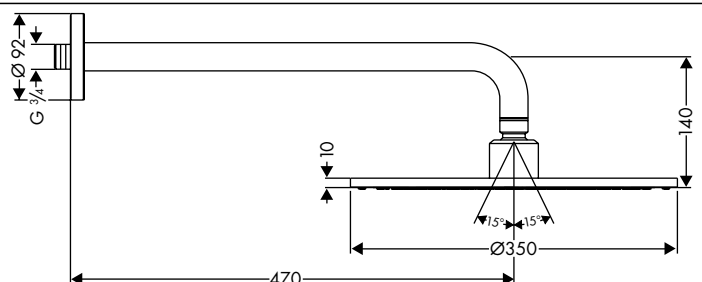



Raindance® Royale 350 overhead shower

Flow rate chart

28420000

Raindance Royale AIR overhead shower

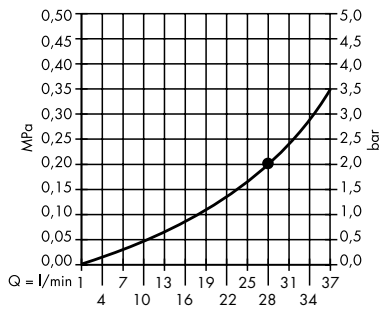

Key

overhead shower

Flow rate chart

27893000

Raindance Unica'S Set 0,90 m

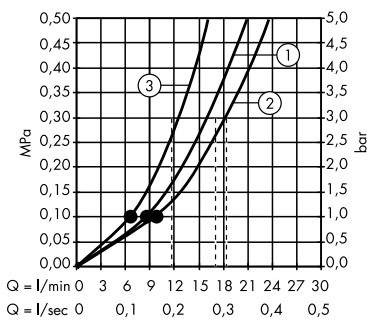

Key

- ① Rain AIR
- ② Mix AIR
- ③ Whirl AIR

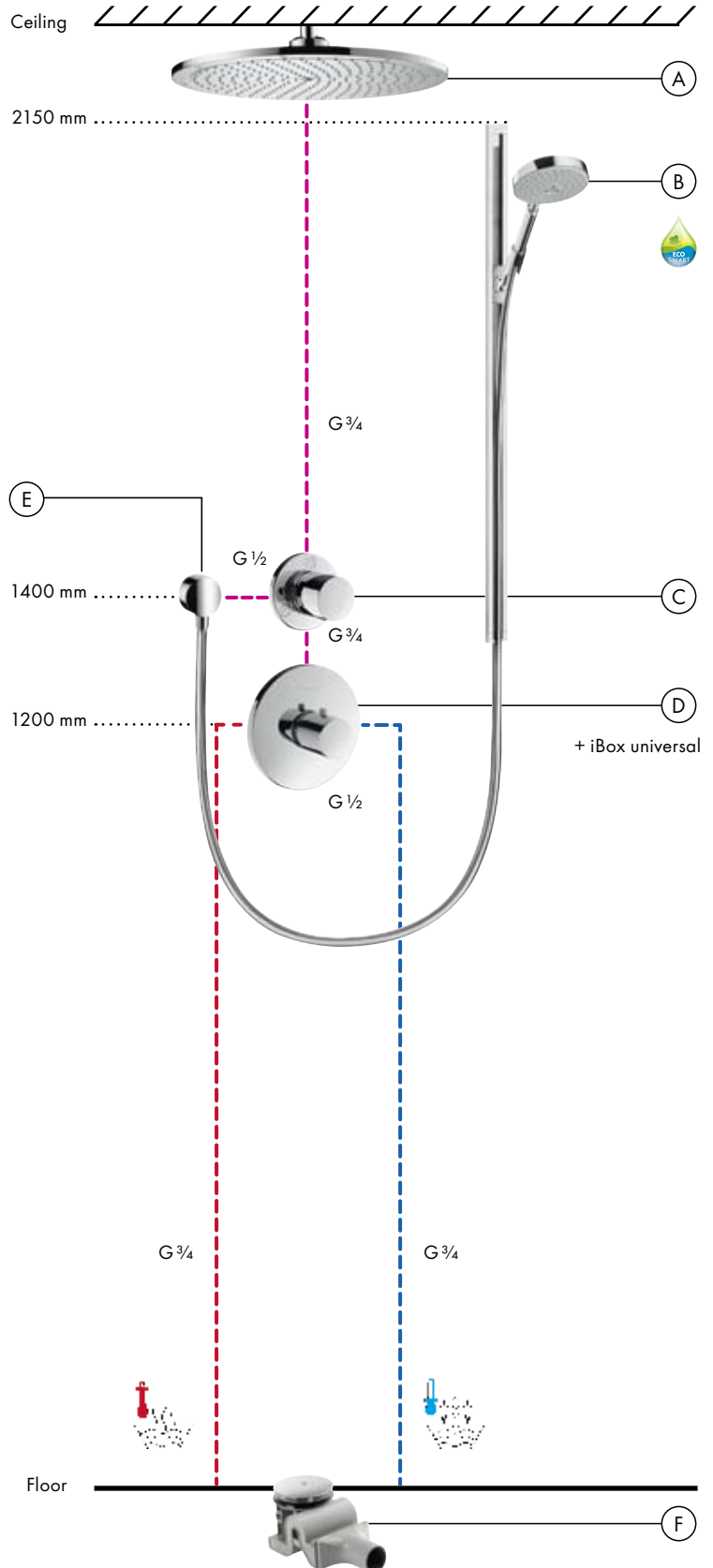

Function guaranteed from • onwards.

Components

- Ⓐ 1x # 2842000 Raindance Royale AIR Ø 350 mm overhead shower
- Ⓑ 1x # 27893000 Raindance Unica'S Set 0.90 m
- Ⓒ 1x # 15932000 Trio S shut-off/diverter valve
- Ⓓ 1x # 15715000 Ecostat S Highflow thermostat
- Ⓔ 1x # 01800180 iBox universal basic set
- Ⓕ 1x # 27418000 Ceiling connector 100 mm
- Ⓖ 1x # 27453000 Fixfit S hose connection
- Ⓗ 1x # 60067000 Raindrain 90 XXL waste set

Product Ⓑ is also available in an EcoSmart version.





System 2: 2-spray overhead showers

Elegance and ergonomics: The Rainfall 180 2jet and Raindance E 420 2jet overhead showers with two spray modes are ideal components for a sophisticated shower system. The compact Rainfall 180 2jet overhead shower exudes timeless elegance, while the width of the Raindance E 420 2jet overhead shower was designed to completely cascade around your shoulders. Both overhead showers offer the choice between the lavish Rain AIR function and the invigorating water fall of the Rainflow flood jet.

Raindance® Rainfall® 180 2jet overhead shower

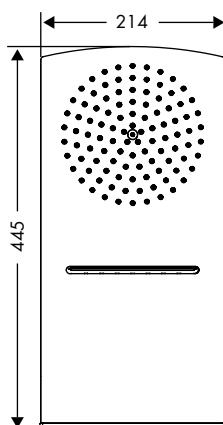
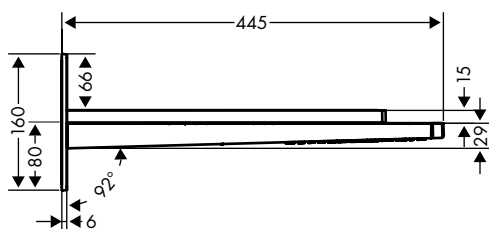

Raindance® E 420 AIR 2jet overhead shower

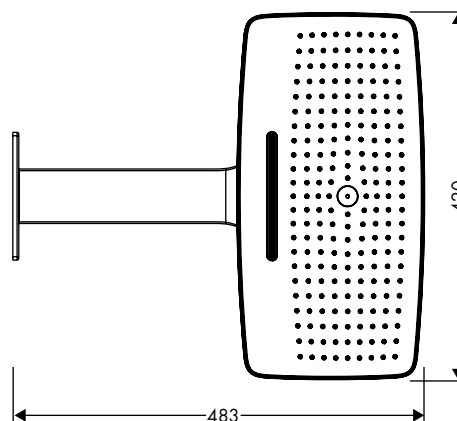
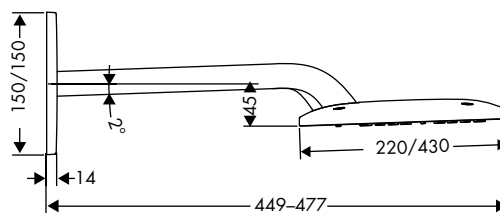

Raindance® Rainfall® 180 2jet overhead shower

Flow rate chart

28433000

Raindance Rainfall overhead shower

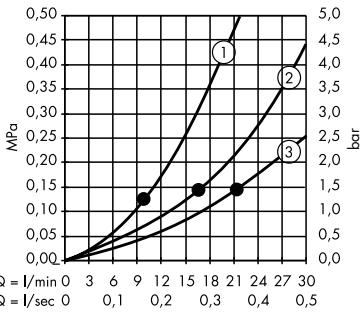

Q = l/min 0 3 6 9 12 15 18 21 24 27 30
Q = l/sec 0 0,1 0,2 0,3 0,4 0,5

Flow rate chart

28504000

Raindance S 100 AIR 3jet hand shower

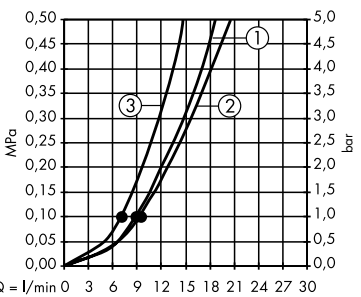

Q = l/min 0 3 6 9 12 15 18 21 24 27 30

Key

- ① Rain AIR
- ② Rainflow
- ③ Rain AIR + Rainflow

Key

- ① Rain AIR
- ② Mix AIR
- ③ Whirl AIR



Function guaranteed from • onwards.

Components

- (A) 1x # 28433000 Raindance Rainfall 180 2jet overhead shower
- 1x # 01800180 iBox universal basic set
- (B) 1x # 28504000 Raindance S 100 AIR 3jet hand shower
- 1x # 28331000 Porter S shower support
- 1x # 28276000 Isiflex shower hose 1.60 m
- (C) 1x # 15932000 Trio S shut-off/diverter valve
- 1x # 15981180 Trio basic set
- (D) 1x # 15715000 Ecostat S Highflow thermostat
- 1x # 01800180 iBox universal basic set
- (E) 1x # 15972000 Shut-off valve S
- 1x # 15974180 Shut-off valve basic set
- (F) 1x # 27453000 Fixfit S hose connection
- (G) 1x # 60067000 Raindrain 90 XXL waste set

Product (B) is also available in an EcoSmart version.



Raindance® E 420 AIR 2jet overhead shower

Flow rate chart

27373000

Raindance E 420 AIR 2jet overhead shower

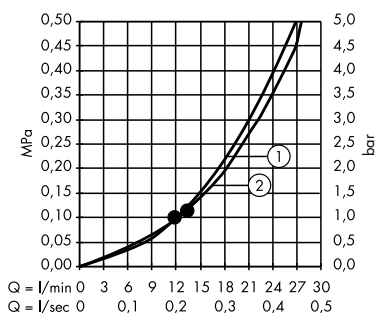

Key

- ① Rain AIR XL
- ② Rainflow

Flow rate chart

28557000

PuraVida 150 3jet hand shower

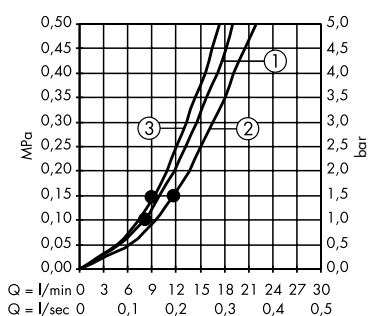

Key

- ① Rain AIR
- ② Mix AIR
- ③ Caresse AIR

Function guaranteed from • onwards.

Components

- Ⓐ 1x # 27373000 Raindance E 420 AIR 2jet overhead shower
1x # 01800180 iBox universal basic set
- Ⓑ 1x # 28557000 PuraVida 150 3jet hand shower
1x # 28331000 Porter S shower support
1x # 28276000 Isiflex shower hose 1.60 m
- Ⓒ 1x # 15777000 iControl shut-off/diverter valve for PuraVida
1x # 01800180 iBox universal basic set
- Ⓓ 1x # 27414000 Fixfit hose connection for PuraVida
- Ⓔ 1x # 15772000 Highflow thermostat for PuraVida
1x # 01800180 iBox universal basic set
- Ⓕ 1x # 60067000 Raindrain 90 XXL waste set

Product Ⓑ is also available in an EcoSmart version.

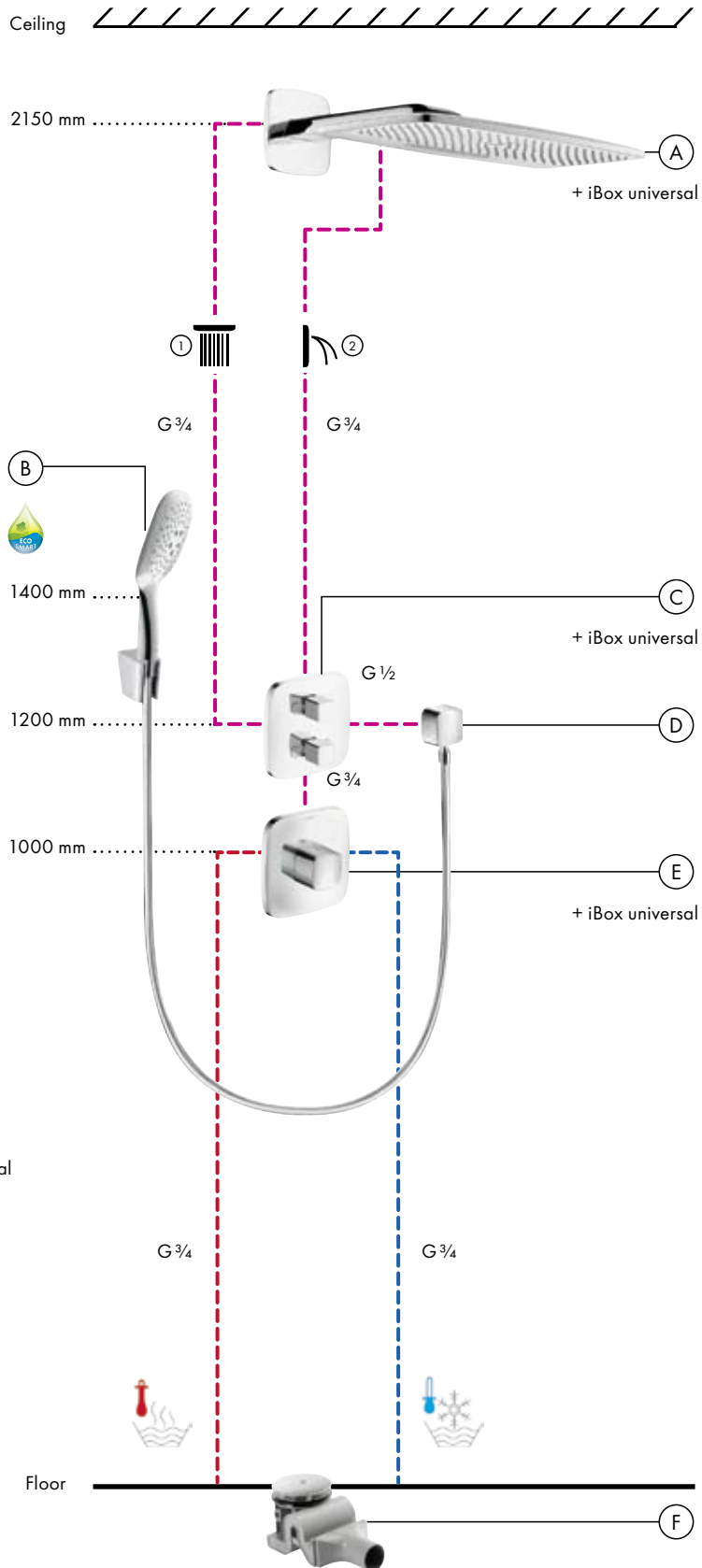





System 3: 3-spray overhead showers

Variety for body and soul: From here on, shower pleasure becomes pure luxury. Our shower systems with 3-spray overhead showers captivate with their unique appearance, all-round shower pleasure and easy operation. The Raindance Rainfall is installed flush with the wall and reaches well into the room. It offers great experience with three spray modes (Rain AIR, Whirl AIR and Rainflow). The Raindance Rainmaker represents showering in even larger dimensions: it is installed flush with the ceiling, creating a completely new and extremely generous sense of space. It is available both in a rectangular and a round version and can also be equipped with lighting.

Raindance® Rainfall® 3jet overhead shower

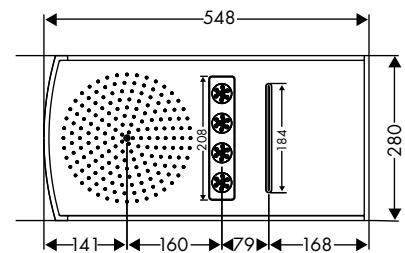

Raindance® Rainmaker® AIR overhead shower

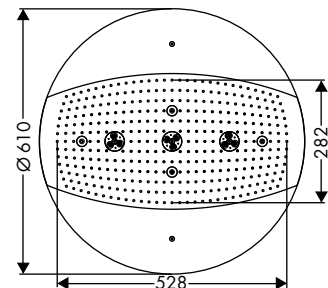

Raindance® Rainmaker® AIR overhead shower

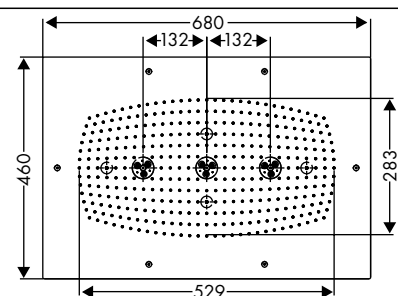
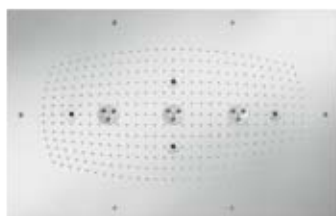

Raindance® Rainfall®

Planning and installation instructions

Wall installation

1. iBox universal as a basic set

The versatile iBox universal concealed installation unit is also used with the overhead shower, providing a rapid and professional installation of the Raindance Rainfall. Considering the exceptional length and weight of this overhead shower, the iBox universal ensures that the Raindance Rainfall is securely mounted and sits perfectly on the wall (product not included in delivery).

Attention: The net weight of the shower without water is 12 kg. Please ensure sufficient wall reinforcement at point of installation!

To direct the water coming from the three G ½ feed pipes to the three shower functions, a fixing aid is needed at the shower – sitting directly on the iBox universal. This solid brass function block integrates the three brass pipes which ensure the stable mounting of the shower.

Another brass pipe is screwed into the fourth (upward-pointing) opening of the iBox universal and attached to the wall with an ordinary pipe clamp, providing additional stability. The middle feed pipe is also secured with a clamp.

The pre-assembled overhead shower panel, including the pre-attached wall escutcheon, is placed over the three shower arms and screwed on at the sides. Finished!

Attention: The shower has to be installed, rinsed and checked in compliance with the applicable regulations in order to guarantee a proper shower function!

Plumbing installation

2. Hot water supply

The dimensions of the shower set-up must be individually established according to personal shower preferences, frequency of usage and the number of desired shower functions. Recommended operating pressure: 3 bar pressure. Hot water temperature: max. 60°C. Recommendation: the storage tank should hold at least 300 litres.

Note: This product cannot be used in combination with continuous flow water heaters. Large differences in pressure between the cold and hot water outlets must be balanced.

3. Feed pipes

iBox universal: 2 x G ¾ (hot/cold)

Rainfall: 3 x G ½ (mixed water)

4. Concealed thermostat on iBox universal base # 15715000 concealed thermostat with increased flow capacity and cylindrical handle not included in delivery. Flow rate 58 l/min at 3 bar.

01800180 iBox universal not included in delivery!

Further options for finish sets (see Product Overview Basic and Finish Sets) and custom-made surfaces are available on request.

5. Shut-off valves G ¾ with cylindrical handle

Not included in delivery!

15970180 Basic Set G ¾ (spindle) for concealed installation, flow rate 130 l/min at 3 bar

15972000 Finish Set Shut-off valve



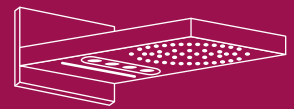

3-spray overhead showers

6. Quattro Diverter Valve G^{3/4} with cylindrical handle

Not included in delivery!

For the easy operation of all three functions:

15930180 Basic Set G^{3/4} with ceramic discs for

concealed installation, flow rate 65 l/min at 3 bar

15932000 Quattro diverter finish set

7. Shut-off valve G^{1/2} with cylindrical handle

Shut-off valve for hand shower

38882000 Hose connector Fixfit Stop

8. Drain

Floor drain (without shower tray):

Raindrain 90 XXL

Drain capacity 51 l/min (damming height 15 mm)
complies with DIN 1247 1-3.



Raindrain 90 XXL Complete Set

60067000

Attention: The drain capacity must be greater
than 50 l/min

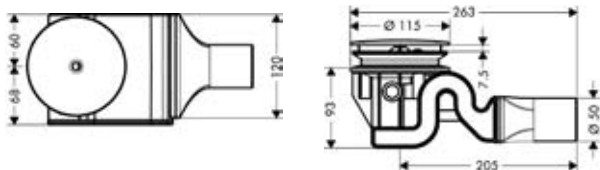

Product description and technical data

Raindance Rainfall overhead shower # 28411000

Includes:

Pre-assembled overhead shower panel with three shower functions for wall mounting

1 x Raindance Rainfall overhead shower
Including wall escutcheon

1 x Function block with three shower arms
(for mounting on the iBox universal)

- chromed brass housing and spray disc
- chromed metal wall escutcheon

240 mm Raindance overhead shower with AIR function for soft, voluminous rain drops and tried-and-tested QuickClean cleaning function.

Wide flood jet (hot or cold water) with high flow capacity for a completely new, natural shower experience.

Three spray modes:

- 1** Rain AIR: Large overhead shower 240 mm
- 2** Whirl AIR: 4 nozzles with rotating massage jets
- 3** Rainflow: Wide flood jet

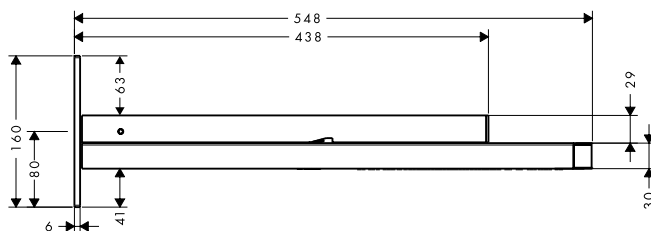
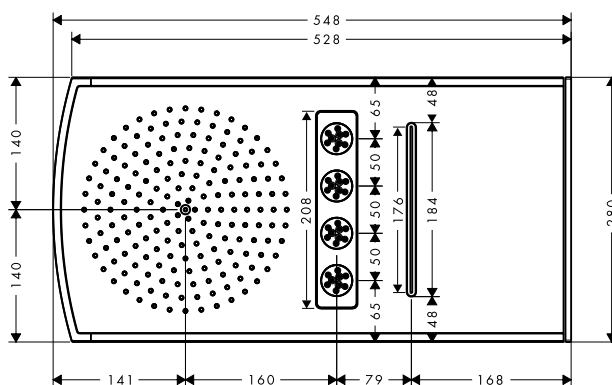
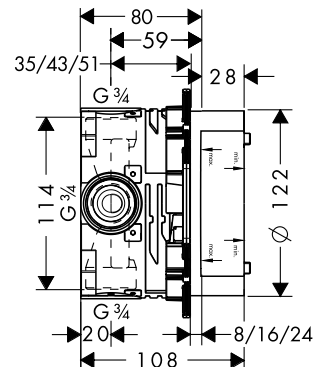
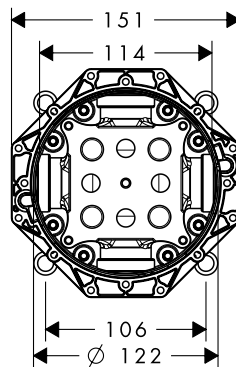



Installation

Installation

In your planning, please consider the size and layout of the shower cubicle and the spray angles of the individual spray modes.

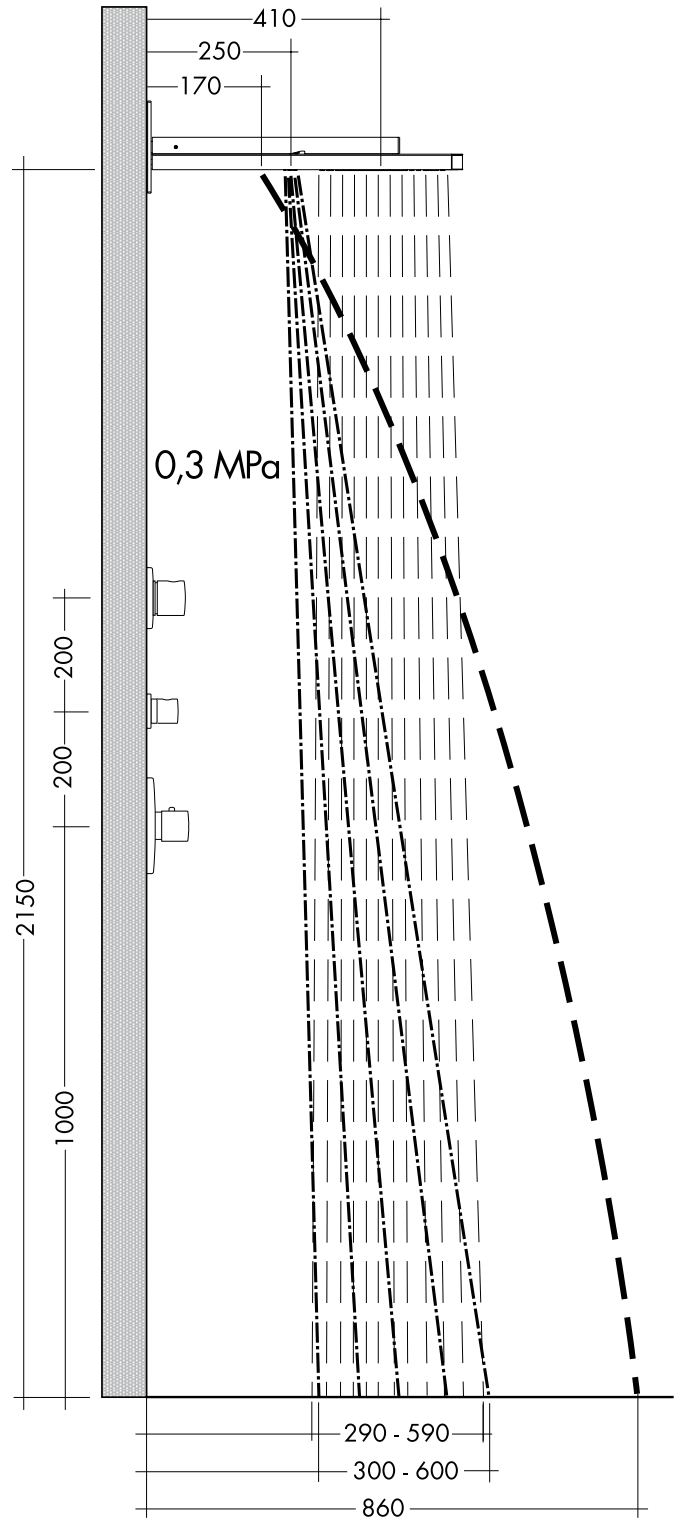
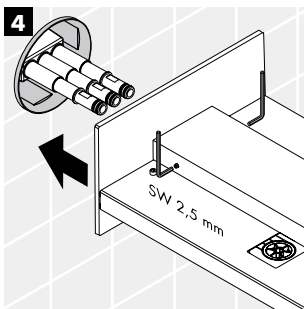
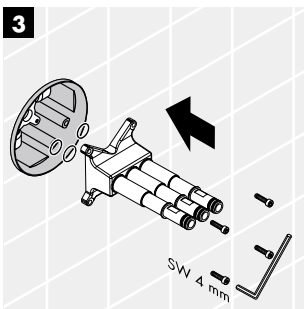
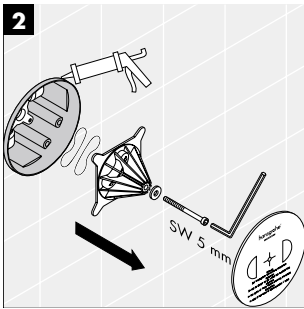
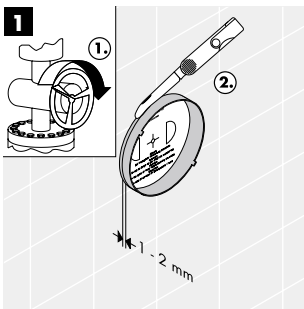

Raindance® Rainmaker® rectangular overhead shower



Flow rate chart

28417000

Raindance Rainmaker overhead shower

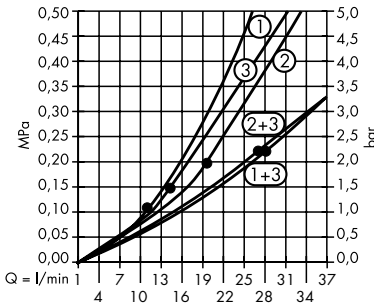

Key

- ① Rain AIR XL
- ② Rain AIR XXL
- ③ Whirl AIR

Flow rate chart

27638000

Raindance Unica'S Set 1,50 m

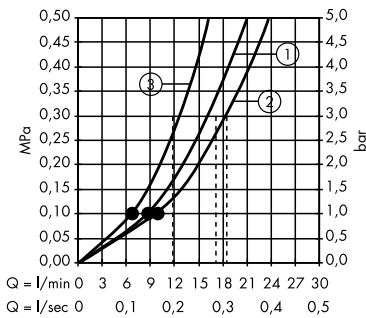

Key

- ① Rain AIR
- ② Mix AIR
- ③ Whirl AIR

Function guaranteed from • onwards.

Components

- Ⓐ 1x # 28417000 Raindance Rainmaker 680 mm x 460 mm overhead shower
- Ⓑ 1x # 15932000 Quattro S diverter valve
- Ⓒ 1x # 15932000 Trio S shut-off/diverter valve
- Ⓓ 1x # 15715000 Ecostat S Highflow thermostat
- Ⓔ 1x # 01800180 iBox universal basic set
- Ⓕ 1x # 27453000 Fixfit S hose connection
- Ⓖ 1x # 27638000 Raindance Unica'S Set 1.50 m
- Ⓗ 1x # 60067000 Raindrain 90 XXL waste set

Product Ⓕ is also available in an EcoSmart version.

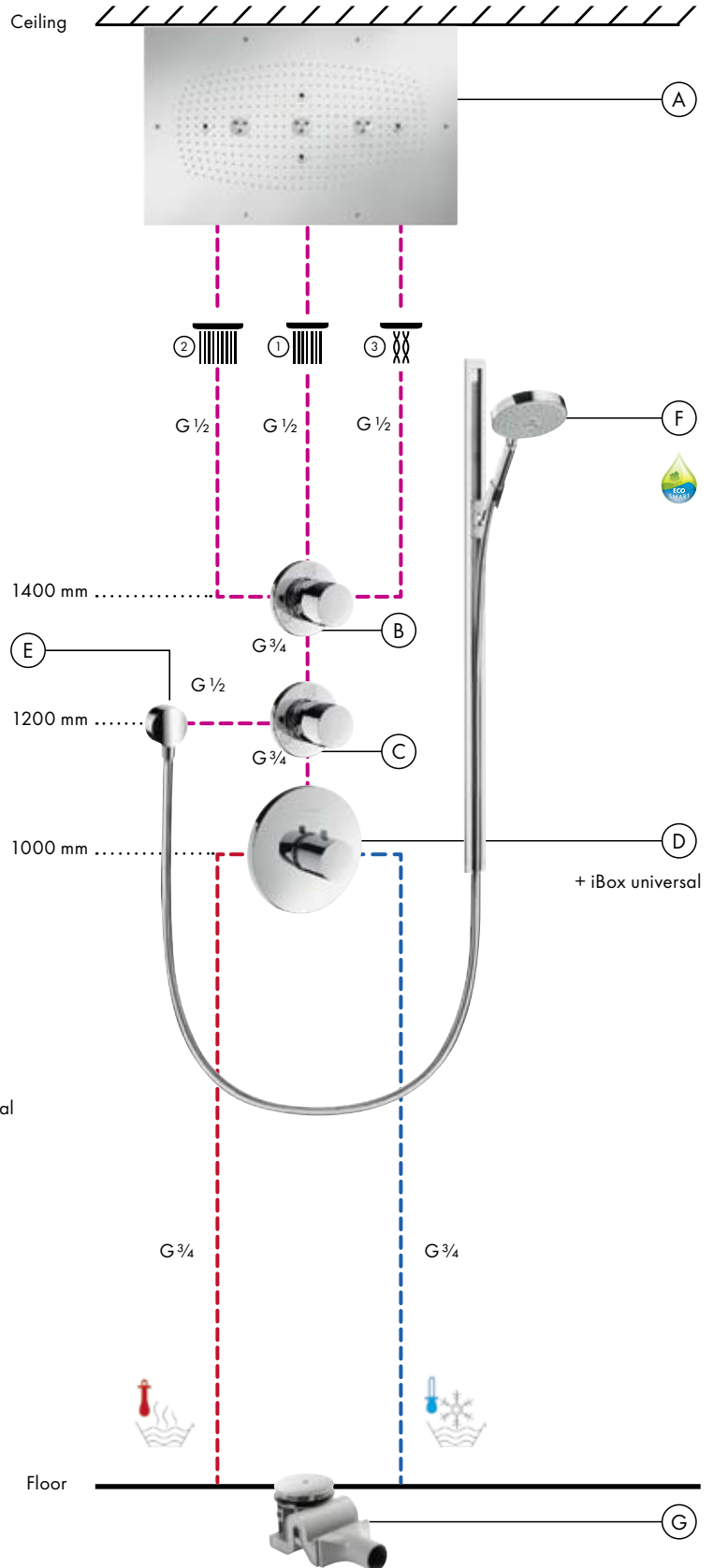

Raindance® Rainmaker®

Planning and installation instructions

Ceiling construction

1. Suspended ceiling

To install the Rainmaker, you need to install a suspended ceiling (made of plaster board for example) yielding a gap of at least 6 cm. Stretched ceilings are an ideal alternative to plaster board sheets (see Installation of plaster board sheets, Installation with stretched ceilings).

The Rainmaker cannot be incorporated into concrete framework installation and sealed afterwards. To install the housing into concrete ceilings and in a plaster board ceiling, a circular opening of 590 mm is recommended, leaving a 5.5 mm overhang. It is possible to install the Rainmaker flush with the ceiling, leaving a circular seam of 7 mm to allow for the installation of cover sheets on the sides.

The Rainmaker's own weight, without water, is around 12 kg.

Attention: Not suitable for direct installation in open spaces adjacent to flammable surfaces.

2. Basic set/Installation instructions

The basic set needs to be ordered in advance and is designed as an installation aid. It doesn't contain any expensive components and can therefore be installed during the early phases of construction. The basic set is required to install the actual finish set. It comprises mainly a polystyrene housing with a spray disc template to enable exact positioning of the Rainmaker in the room and fixing of the three connecting hoses. Thanks to the supplied plugs, it is possible to do a pressure test at this early stage. All attachment screws for the basic and finish set are also included. Before the final installation, the polystyrene finish set dummy is broken up and removed.



Plumbing installation

3. Hot water supply

The capacity of the shower set-up must be individually established according to personal shower preferences, frequency of usage and the number of desired shower functions. Operating pressure at the thermostat: max. 1 MPa. Recommended operating pressure: 3 bar pressure. Hot water temperature: max. 60 °C. Recommendation for the storage tank: the storage tank should hold at least 300 litres.

Note: This product cannot be used in combination with continuous flow water heaters. Large differences in pressure between the cold and hot water outlets have to be balanced.

4. Supply lines

iBox universal: 2 x G 3/4 (hot/cold)

Rainmaker: 3 x G 1/2 (mixed water)

5. Concealed thermostat on iBox universal base # 15715000 concealed thermostat with increased flow capacity and cylindrical handle included in delivery. Flow rate 58 l/min at 3 bar.

01800180 iBox universal not included in delivery!

Further options for finish sets (see Product Overview Basic and Finish Sets) and custom-made surfaces are available on request.

6. Shut-off valve G 3/4 with cylindrical handle

Not included in delivery!

15970180 Basic Set G 3/4 (spindle) for concealed installation, flow rate 130 l/min at 3 bar

15972000 Finish Set Shut-off valve

7. Quattro Diverter Valve G 3/4 with cylindrical handle

Not included in delivery!

For the easy operation of all three functions:

15930180 Basic Set G 3/4 with ceramic

discs for concealed installation, flow rate 65 l/min at 3 bar

15932000 Quattro diverter finish set

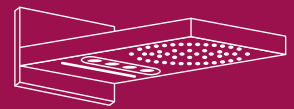

3-spray overhead showers

8. Shut-off Valve G 1/2 with cylindrical handle

Shut-off valve for hand shower

38882000 Hose connector Fixfit Stop

Waste Technology

9. Drain

Floor drain (without shower tray)

Drain for shower tray: Raindrain 90 XXL

Drain capacity 51 l/min (15 mm damming height),
complies with DIN 1247 1-3.



Raindrain 90 XXL Complete Set
60067000

Attention: The drain capacity must be greater than 50 l/min

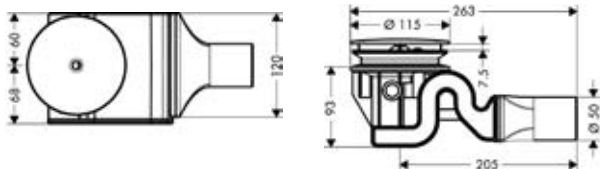

Electrical installation

10. Feed line (2 x 1,5 mm²)

Electrical junction box included in the basic set Note: Make sure ducting is laid for the power supply (lighting). Equipotential bonding is not required.

Attention: Connection of electricity must be carried out by an electrician! Power supply 230V/N/PE/50Hz (length 0.3 m). Protection must be provided via a residual current-operated protective device (RCD/FI) with a maximum residual operating current of 30 mA.

11. Light switch

Must be installed outside the shower area or connected with the ceiling light (outside protection area two according to WRC regulations).

12. Transformer

Secondary output voltage 12V/35-80 VA,
dimensions 110 mm x 21 mm x 45 mm.

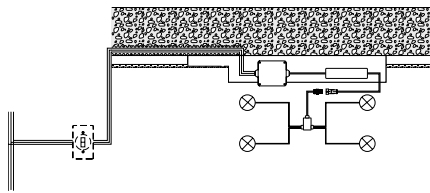

Product description and technical data

Rainmaker Basic set # 28412180

Contents:

- 1x polystyrene housing with template
- 1x electrical junction box with connection accessories
- 2x connecting hoses 800 mm, G 1/2
(1 straight connection, 1 elbow connection)
- 1x connecting hose, 800 mm, G 1/2
(2 straight connections)

Mounting material

(included in basic set)

The supplied plugs are suitable for concrete ceilings. For other building materials suitable mounting elements must be used. The plugs supplied are

- 4x washers
- 4x stainless steel nuts M 8
- 4x plastic plugs Ø 10 mm
- 4x hanger bolts M 8 x 100 mm
(for installation heights > 10 cm longer hanger bolts will need to be purchased separately)
- 4x stainless steel screws
- 4x plastic plugs
- 4x washers Ø 6 x 22 mm
- 1x belt strap (for secure installation)

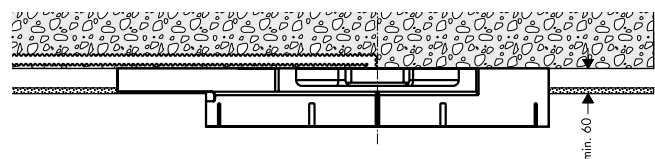
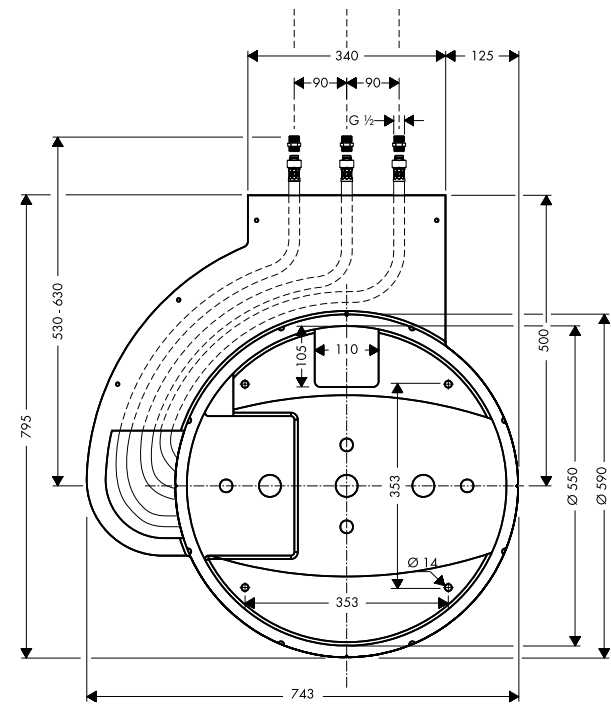
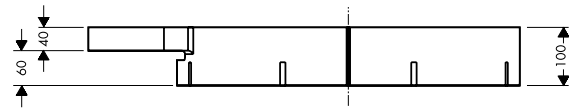



Installation

Raindance Rainmaker Finish set without lighting # 28403000

Content:

Concealed high-flow thermostat on iBox universal base

15715000

Pre-assembled overhead shower system with three available functions:

- 1) central overhead shower 264 x 282 mm
- 2) full body shower 528 x 282 mm
- 3) massage jets 264 mm

358 jet elliptical spray disc with the proven elastic silicon nipple based QuickClean de-scaling function. Same look as # 28404000 but without glass light elements.

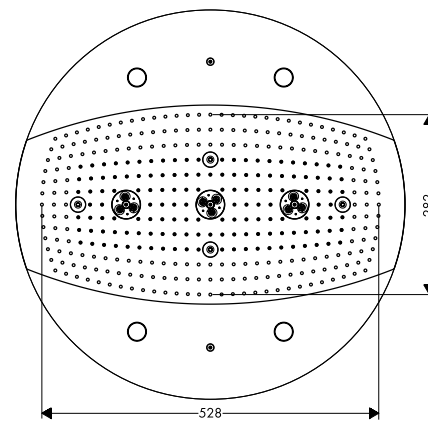
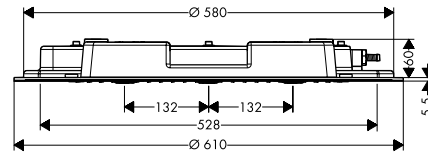

Raindance Rainmaker Finish set with lighting # 28404000

Construction and function as # 28403000

in addition 4 x 20 halogen lamps, type 50020 Osram

Ministar, transformer with secondary output voltage

12 V/35-80 VA, 110 mm x 21 mm x 45 mm,

concealed high-flow thermostat on iBox universal base

15715000

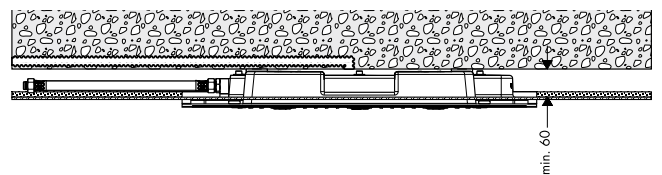

Raindance Rainmaker housing

For clearer presentation of the details the housing is here shown in grey; in the original it is black.



3-spray overhead showers with side showers

Water from all directions: When the entire Hansgrohe shower family consisting of hand shower, overhead shower and side showers are brought together, the result is a system that creates a total sense of wellbeing.



Rain AIR

Air is drawn in through the entire spray disc and mixed together with the inflowing water. As a result, the drops become larger, lighter and softer. A natural rain shower is created.

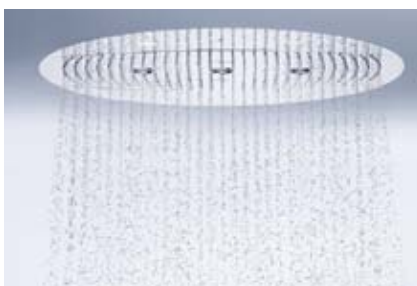

Rain AIR XXL

The Rain AIR function in maximum size: a down-pour of water envelopes the entire body.



Whirl AIR

This function also mixes water with air. The air is compressed into a very small space, which accelerates the outflowing massage jets. The result is a powerful massage with a rotating jet.



3-spray overhead shower Raindance® Rainmaker® with side shower

Flow rate chart

28403000

Raindance Rainmaker overhead shower

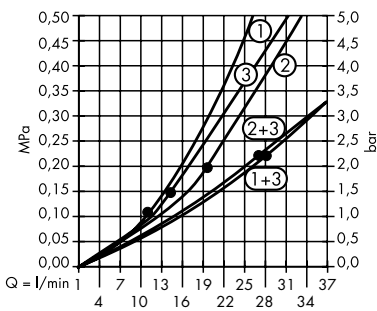

Key

- ① Rain AIR XL
- ② Rain AIR XXL
- ③ Whirl AIR

Flow rate chart*

28477000

Raindance AIR side shower

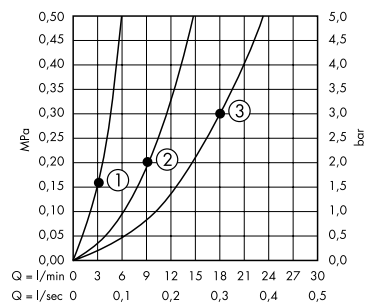

Key

- ① 1 Body shower
- ② 3 Body showers
- ③ 6 Body showers

Function guaranteed from • onwards.

* Flow rate chart # 27638000 Raindance Unica'S Set see page 25.

Components

- | | |
|---|---|
| <ul style="list-style-type: none"> Ⓐ 1x # 28403000 Raindance Rainmaker Ø 600 mm overhead shower 1x # 28412180 Raindance Rainmaker basic set | <ul style="list-style-type: none"> Ⓓ 1x # 15932000 Trio S shut-off/diverter valve 1x # 15981180 Trio basic set |
| <ul style="list-style-type: none"> Ⓑ 1x # 15955000 iControl manual shut-off/diverter valve 1x # 01800180 iBox universal basic set | <ul style="list-style-type: none"> Ⓔ 1x # 27453000 Fixfit S hose connection Ⓕ 1x # 27638000 Raindance Unica'S Set 1.50 m Ⓖ 6x # 28477000 Raindance AIR side shower |
| <ul style="list-style-type: none"> Ⓒ 1x # 15715000 Ecostat S Highflow thermostat 1x # 01800180 iBox universal basic set | <ul style="list-style-type: none"> Ⓗ 1x # 60067000 Raindrain 90 XXL waste set |
- Product Ⓔ is also available in an EcoSmart version.

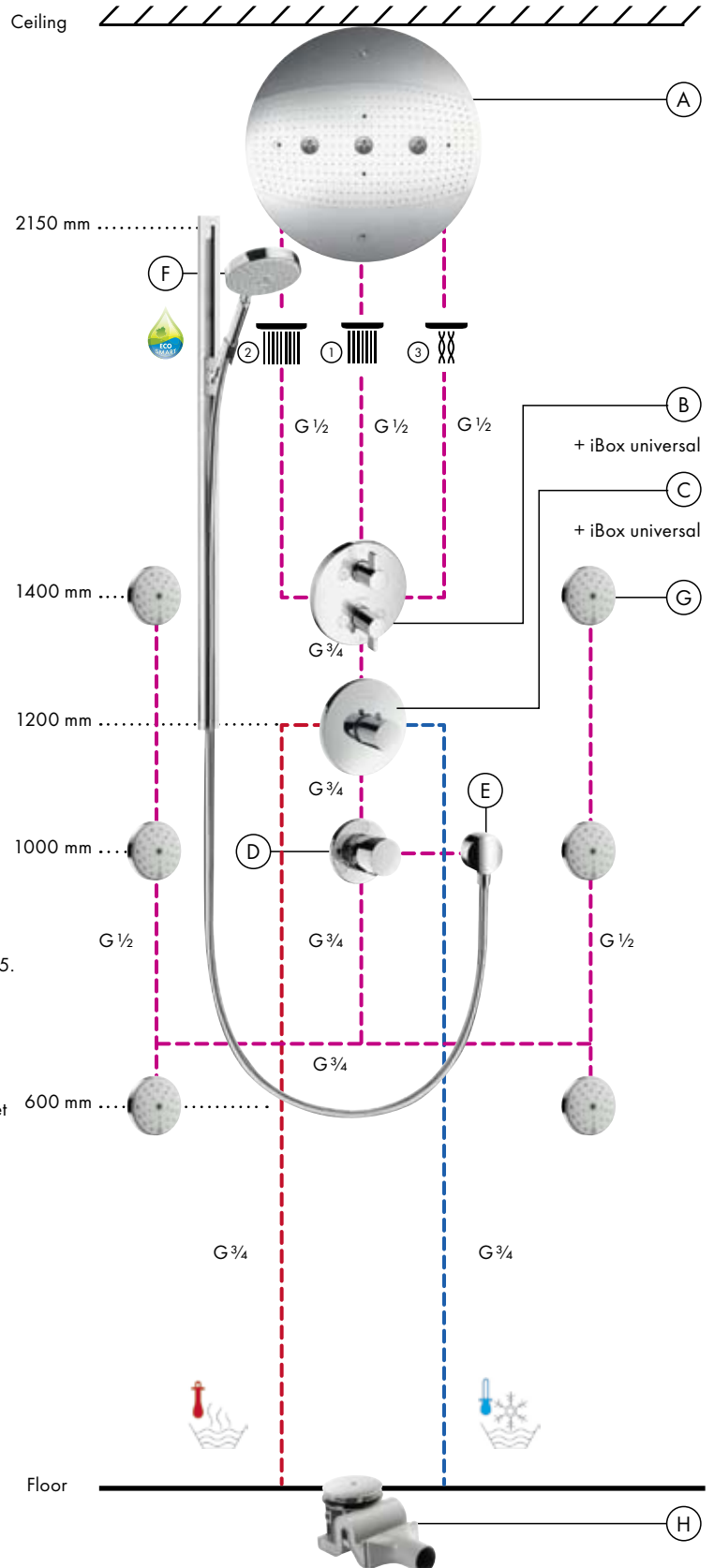



Raindance® Showerpipe 240 for the shower

Flow rate chart

27160000

Raindance Showerpipe 240 overhead shower

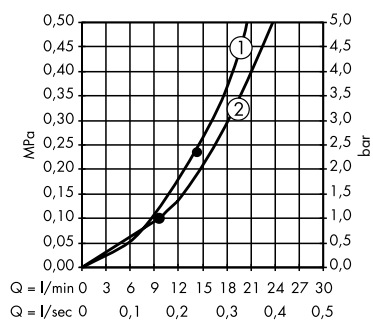

Key

- ① overhead shower
- ② hand shower

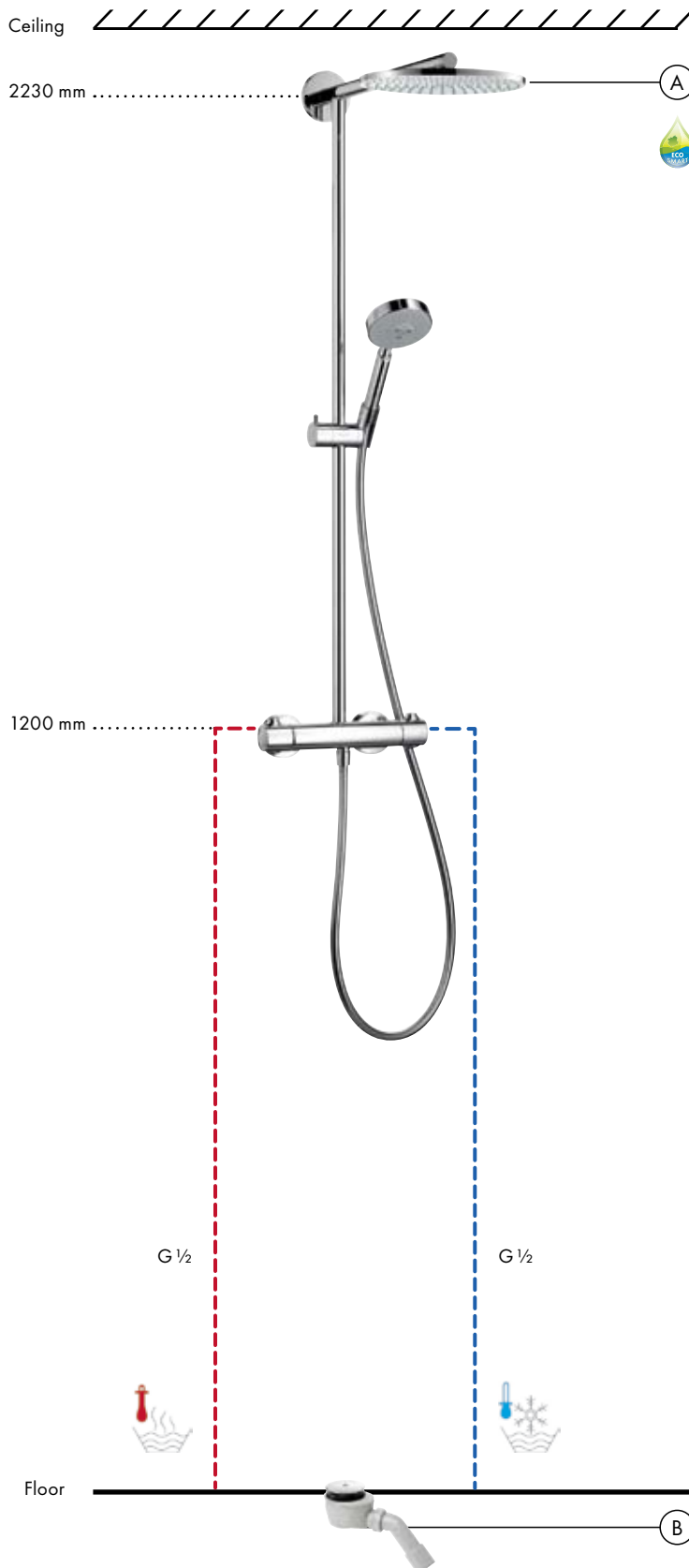

Components

- Ⓐ 1x # 27160000 Raindance Showerpipe 240 Shower arm 460 mm, G 1/2
- Ⓑ 1x # 60056000 Staro 90 waste set

Product Ⓐ is also available in an EcoSmart version.



Raindance® Showerpipe 240 for the bath tub

Flow rate chart

27147000

Raindance Showerpipe 240 overhead shower for the bath tub

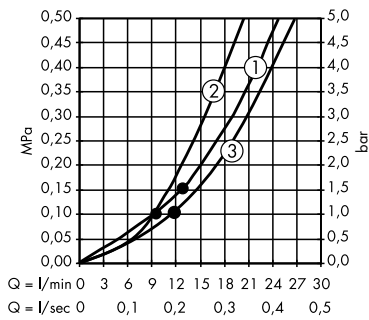

Key

- ① overhead shower
- ② hand shower
- ③ bath filler

Function guaranteed from • onwards.

Components

- Ⓐ 1x # 27147000 Raindance Showerpipe 240 for the bath tub
Shower arm 460 mm, G 1/2
- Ⓑ 1x # 58143000 Flexaplust Waste and overflow

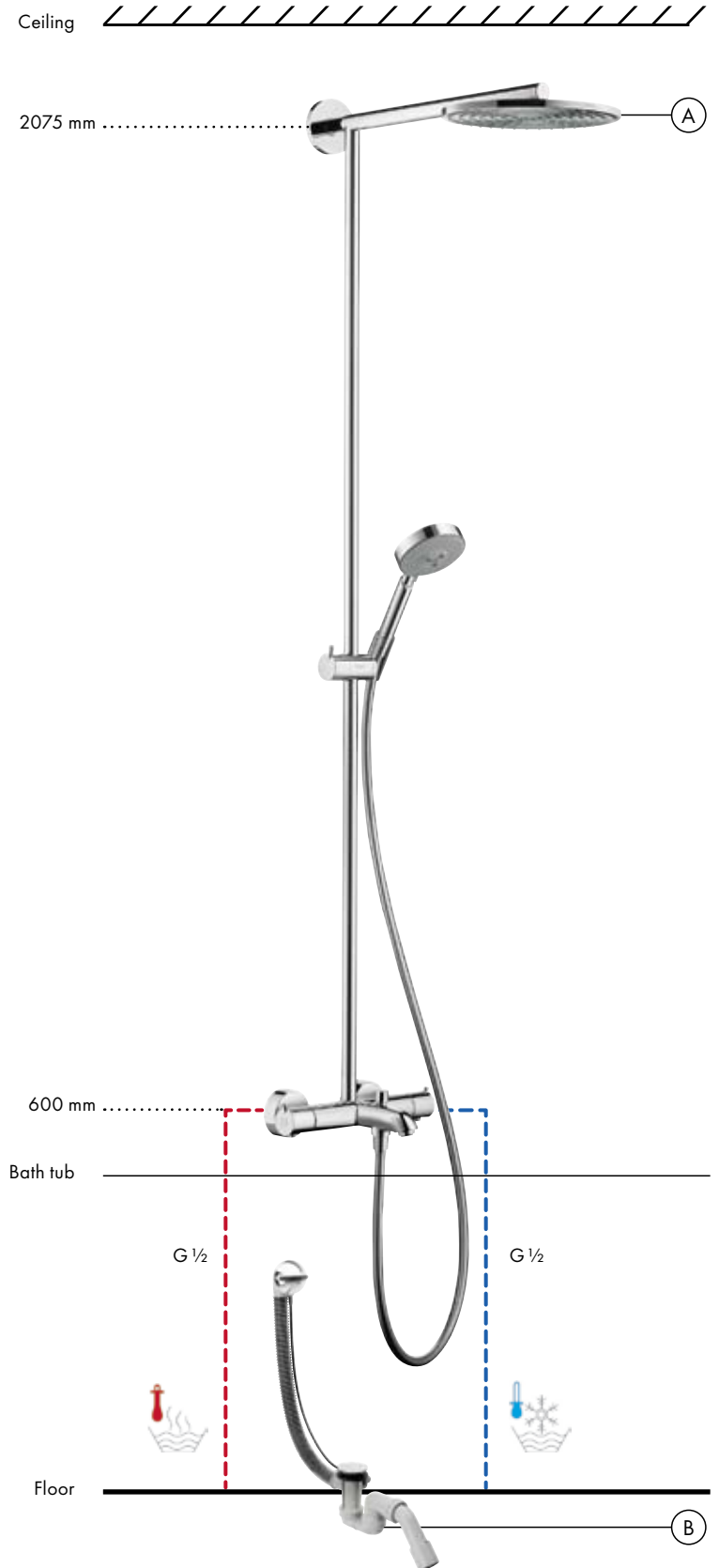

Raindance® Showerpipe 240 for the shower

Flow rate chart

27145000

Raindance Showerpipe 240

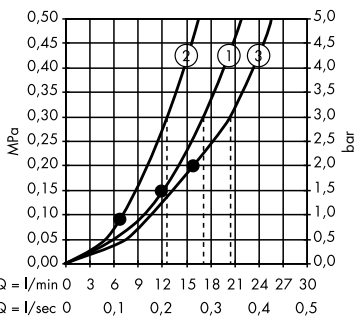

Function guaranteed from • onwards.

Key

- ① overhead shower
- ② hand shower
- ③ overhead shower + hand shower

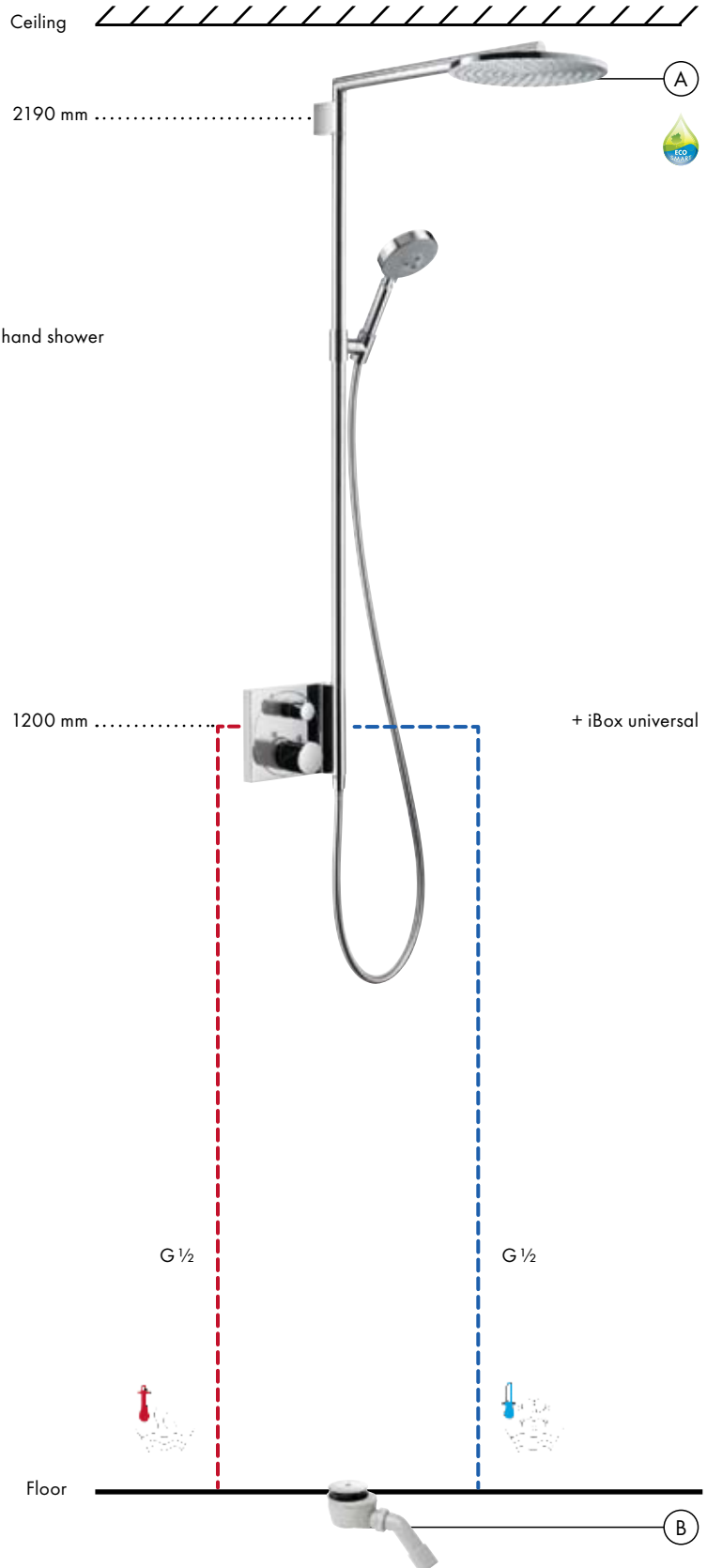

Components

- (A) 1x # 27145000 Raindance Showerpipe 240 concealed installation shower arm 460 mm, G 1/2
- 1x # 01800180 iBox universal basic set
- (B) 1x # 60056000 Staro 90 waste set

Product (A) is also available in an EcoSmart version.



Raindance® Connect Showerpipe 240

Flow rate chart

27421000

Raindance Connect 240

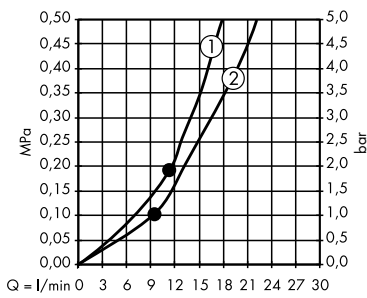

Key

- ① overhead shower
- ② hand shower

Function guaranteed from • onwards.

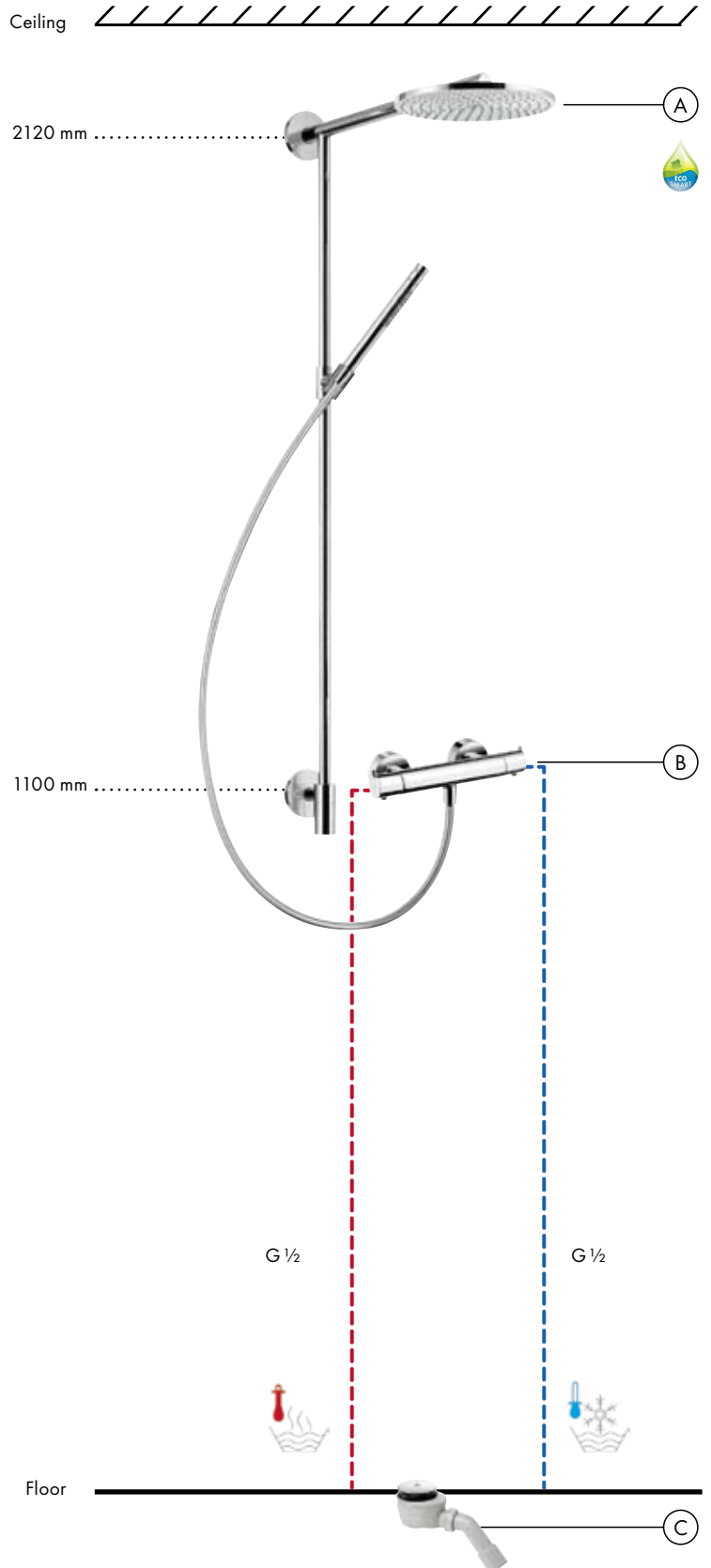

Components

- Ⓐ 1x # 27421000
Raindance Connect
Showerpipe 240
Shower arm 350 mm, G ½
Easy to mount on any existing
mixer or shower connection.
- Ⓑ 1x # 13235000
Ecostat S Shower
- Ⓒ 1x # 60056000 Staro 90
waste set

Product Ⓐ is also available in
an EcoSmart version.

Hansgrohe iBox® universal – Flexibility that benefits everyone

In the world of installation, the iBox universal has long been a standard for concealed fittings. Since its introduction, it has been the one and only basic set for all Hansgrohe and Axor standard thermostats. With the iBox universal, Hansgrohe offers an extremely flexible concealed installation system which allows a basic set built into the wall to be connected to various finish sets for mixers and showers. It can be connected to several different attachments in a variety of ways.



Possible iBox® universal combinations

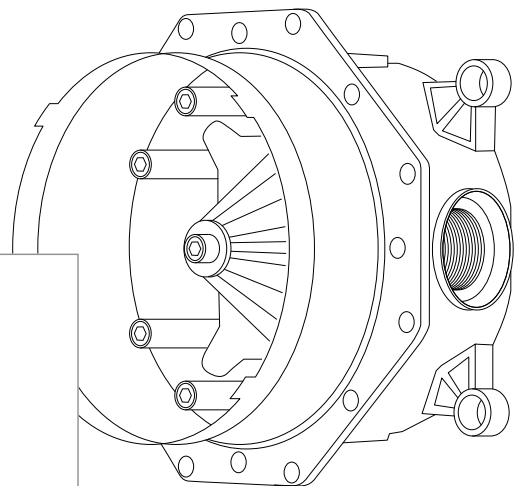

Concealed Installations;

1. Single lever bath mixer
2. Single lever bath mixer/ safety combination
3. Single lever shower mixer
4. Ecostat® S thermostat
5. Ecostat® S Highflow thermostat
6. Ecostat® S therm shut-off valve
7. Ecostat® S therm shut-off & diverter valve
8. Ecostat® S Start/Stop thermostat
9. iControl® manual
10. iControl® mobile
11. Raindance® Rainfall®
12. Raindance® E 420 2jet overhead
13. Raindance® Showerpipe 240
14. Raindance® Showerpanel®
15. Axor® Urquiola bath filler
16. iModul®

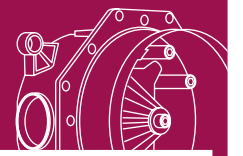

iBox® universal

The many advantages of the iBox® universal

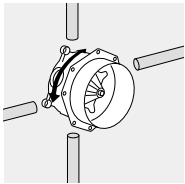

Rotationally symmetrical installation

- Symmetrical structure; all connections are equal.
- It is important that the cold water is connected on the right and the hot water on the left.
- When used as a bath mixer, the lower outflow takes priority.
- When the iBox universal is used as a shower mixer, either the upper or lower outflow can be connected.

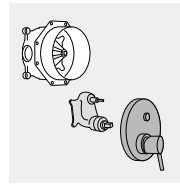

Safe and economical

- The basic set contains just the connection block. The valuable fitting aid is delivered and installed later, together with the finish set.
- Prevents problems like theft, dirt and frost occurring during the building phase; expensive warehousing becomes unnecessary.

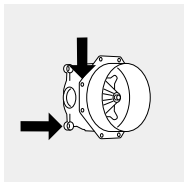

Multiple installation options

- Coordinated with all current installation systems and all types of connections and fittings.
- Patented flexible adjustment ring.
- Mounting options at two levels and G^{3/4} connections for universal installation possibilities.
- Also suitable for thicker walls and dry wall installations as well as for pre-fabricated housing systems.

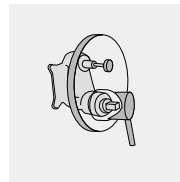

Integrated safety combination

- When installing a concealed single lever bath mixer with integrated safety combination – together with an Exafill bath filler with waste and overflow set – an external pipe interrupter becomes unnecessary. This reduces installation costs as well as the number of functional parts inside the wall.

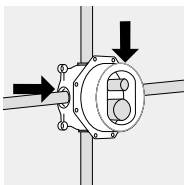

Excellent protection against humidity

- Seals on all four connections and the supporting collar which seals against splashing water perfectly protect the wall against moisture coming from any direction.

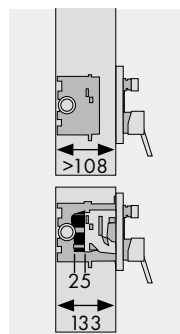

Solutions for walls that are either very thick or very thin

- If the iBox universal sits too deep in the wall, the basic unit extension is fitted between the connector and the function block.
- The extension set ensures safety right up to the wall and keeps the walls free from dampness.
- The iBox universal standard basic set has been made flatter and is now even better suited for walls with limited installation depths.

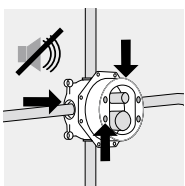

Low noise level

- The brass body rests on seals, preventing sound from the water-conducting parts from being transferred through the wall.
- The supporting collar is screwed to the iBox universal housing and not to the function block, which prevents sound from being transferred through to the tiles.

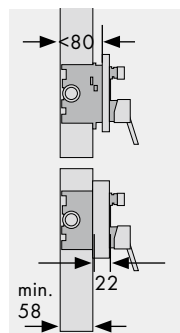

Collar extension

- Thanks to the extension, even limited installation depths are no longer a problem.
- The extension collar makes it possible to install the iBox universal despite the lack of depth.

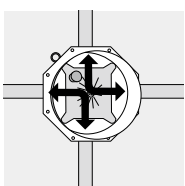

Easy rinsing

- The rinse block supplied with the iBox universal can be mounted in different positions. This makes it easy to rinse pipes through to where they finish at the wall.

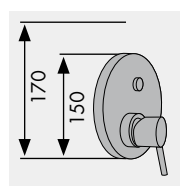

Compatible with smaller escutcheon diameters

- The operating handles and escutcheons of the various mixer series are becoming more and more minimalist.
- The iBox universal is compatible with concealed mixers of 170 mm and 150 mm diameters.

Ideal for all Axor and Hansgrohe basic and finish sets

With the iBox universal, Hansgrohe offers a solution that covers all concealed installations using Hansgrohe and Axor mixers. All shut-off and diverter valves and all thermostats from both brands can be easily combined with the iBox.

It is suitable for six different functional solutions (G 1/2 and G 3/4 installations). For the Raindance, Rainmaker, Rainfall and Royale overhead showers you need the matching concealed installation thermostat with increased flow capacity on the iBox universal base. Thanks to the iBox universal technology all options are left open – even after the construction phase. The valuable fitting aid can be delivered and installed afterwards, together with the finish set.



Spindle basic set, G 3/4
15970180
Spindle basic set, G 1/2
15973180
Ceramic basic set, G 1/2
15974180



Trio basic set
15981180
Quattro basic set
15930180



iBox® universal
Basic set for concealed installation thermostat
01800180
Extension 25 mm
13595000
Collar extension
13596000

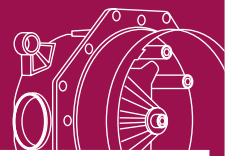

Possible combinations

Thermostats

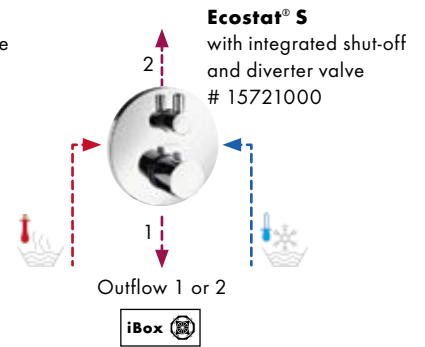
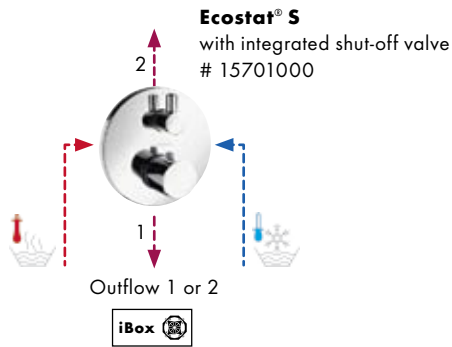
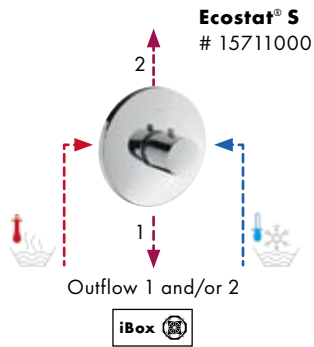



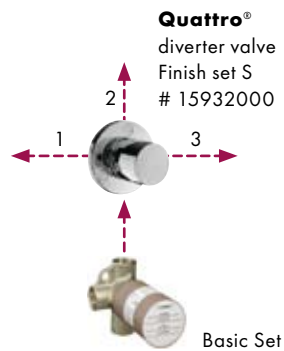
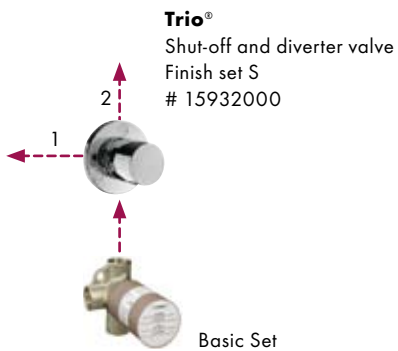
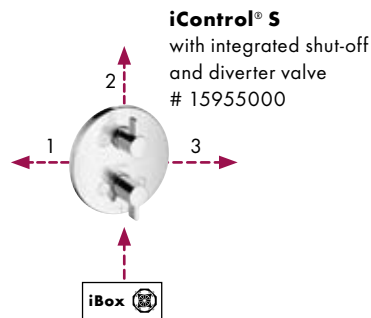
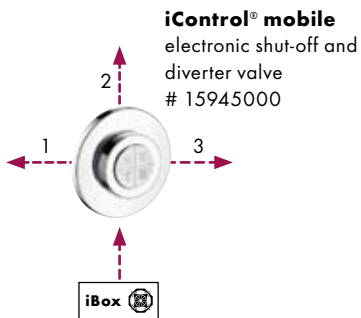



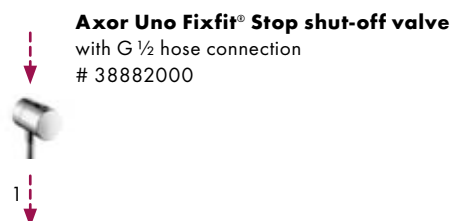
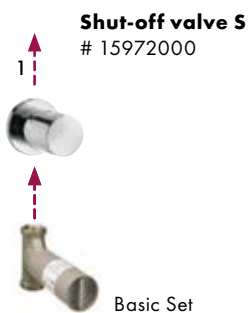













Shut-off and diverter valves



Shut-off valves



Hansgrohe finish sets

| | Hansgrohe PuraVida® | Hansgrohe E | Hansgrohe S | Hansgrohe Classic |
|------------------------------------|---|---|--|--|
| Trio/Quattro |  # 15937400 |  # 15931000 |  # 15932000 |  # 15934000 |
| Shut-off valve |  # 15978400 |  # 15971000 |  # 15972000 |  # 15961000 |
| Thermostat |  # 15772400 |  # 15710000 |  # 15715000 |  # 15754000 |
| Shut-off and diverter valve | Hansgrohe PuraVida® | Hansgrohe E | Hansgrohe S | |
| Shut-off and diverter valve |  # 15777400 |  # 15958000 |  # 15955000 | |
| Thermostat |  # 15772400 |  # 15710000 |  # 15715000 | |
| Thermostat | Hansgrohe PuraVida® | Hansgrohe E | Hansgrohe S | |
| Thermostat |  with integrated shut-off and diverter valve # 15771000 with integrated shut-off valve # 15775000 |  with integrated shut-off and diverter valve # 15720000 with integrated shut-off valve # 15700000 |  with integrated shut-off and diverter valve # 15721000 with integrated shut-off valve # 15701000 | |

Please refer to the Hansgrohe price list or the Hansgrohe catalogue for the different surface finish options.



Axor finish sets

Axor Starck

Axor Starck X

Axor Citterio

Axor Citterio

Trio/Quattro



10930000



10934000



Cross head handle
39925000



Lever handle
39920000

Shut-off valve



10970000



10974000



Cross head handle
39965000



Lever handle
39960000

Thermostat



10715000



10717000



Cross head handle
39716000



Lever handle
39711000

Axor Urquiola

Axor Massaud

Axor Citterio M

Axor Uno²

Trio/Quattro



11925000



18730000



34920000



38933000

Shut-off valve



11960000



18770000



34960000



38976000

Thermostat



11731000



18741000



34716000



38715000

Axor Carlton

Axor Carlton

Axor Montreux

Trio/Quattro



Cross head handle
17925000



Lever handle
17920000



16830000

Shut-off valve



Cross head handle
17965000



Lever handle
17960000



16871000

Thermostat



Cross head handle
17716000



Lever handle
17712000



16815000



RainBrain® – the mastermind in the shower

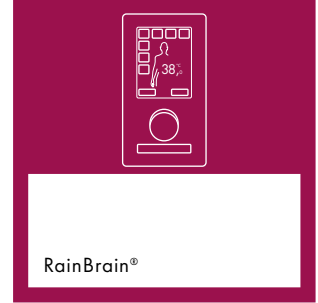

RainBrain is another genuine innovation from Hansgrohe: a control for shower programmes, operated intuitively via touch-screen. For example, you can activate the different functions at the touch of a button, and then focus on nothing else except enjoying your shower. And it's not only showering that becomes more comfortable – you can even send music from your MP3 player to your RainBrain.



Planning and installation instructions



1. Hot and cold water supply

The specific dimensions of each system must be determined according to personal preferences, frequency of usage and the number of users. Operating pressure max. 1 MPa. Recommended operating pressure: 0.2-0.5 MPa (1 MPa = 10 bar = 147 PSI). Hot water temperature: max. 60 °C. When calculating the storage and drain capacity, bear in mind that, depending on which showers are combined, up to 48 l/min of mixed water are needed at 0.3 MPa.

Attention: This product cannot be used in combination with continuous flow water heaters. Large differences in pressure between the cold and hot water outlets must be equalized.

2. Shower feed pipes

Function box: 2 x G³/₄ hot/cold

Rainfall: 3 x G¹/₂ mixed water
(if flow pressure < 3 bar G³/₄)

Hand shower: 1 x G¹/₂ mixed water

Side showers: 1 x G³/₄ mixed water

3. Hansgrohe RainBrain connecting bridge

The connecting bridge serves as a base for the function box, and as a connection for both the hot and cold water feed pipes and the five shower feed pipes. Installation is carried out during the construction phase.

Attention: The connecting bridge must be mounted perpendicular to the vertical feed pipes, rinsed and checked in accordance with the applicable regulations and connected to the equipotential bonding grid.

Connection threads:

2 x G³/₄ internal thread for hot and cold water connection

4. Hansgrohe RainBrain function box

The function box houses: Electronic temperature control, water flow control if applicable, five magnetic valves to control the shower functions, power supply unit, the electronic control system and lighting control. Proper installation of the function box and the connecting bridge requires that an appropriate installation space must be reserved (minimum safety zone two).

Attention: It is essential that the function box is easily accessible for maintenance.

The function box is connected to the control panel in the shower area via a 7 m cable. The connection cable is laid in a Ø 25 mm PE empty conduit. The function box is mounted during the finishing phase of the bathroom.

Power supply: 230 V/50 Hz direct connection.

5. Hansgrohe RainBrain installation housing for the control panel

The installation housing serves as a base for the control panel and is installed during the construction phase. The required installation depth is 84 mm. An empty Ø 25 mm conduit (control cable) must be laid between the installation housing and the function box, and a Ø 20 mm empty conduit (audio cable) must be laid between the function box and the audio amplifier. The control panel is not inserted into the installation housing until the finishing phase of the bathroom.



RainBrain®

Control cable: 7 m long, Ø 25 mm PE empty conduit; audio cable: 7 m long, Ø 20 mm PE empty conduit.

6. Hansgrohe RainBrain control panel

The control panel for controlling the different shower functions is inserted into the installation housing during the finishing phase of the bathroom.

7. Hansgrohe Raindance Rainfall

Quick and simple installation of the Raindance Rainfall is facilitated by using the iBox universal. Considering the exceptional length and weight of this overhead shower, the iBox universal ensures that the Raindance Rainfall is securely mounted and sits perfectly on the wall (product not included in delivery).

Attention: The net weight of the shower without water is 12 kg. Please ensure sufficient wall reinforcement at point of installation, especially in drywall construction!

The mixed water is fed through G ½/G ¾ feed pipes into the bottom opening and two side openings of the iBox universal. Another brass pipe (approx. 10 cm long) is screwed into the fourth (upwards-pointing) opening of the iBox universal and attached to the wall with a pipe clamp. This provides additional stability. The bottom feed pipe is also secured with a pipe clamp. For plastic pipes, an additional brass nipple must be used. The pre-assembled overhead shower panel, including the pre-attached wall escutcheon, is then simply slid onto the iBox universal and screwed on at the sides. Finished!

Attention: The shower must be installed, rinsed and checked in accordance with the applicable regulations in order to ensure proper shower function!

8. Hansgrohe Fixfit hose connection

27453000 Fixfit S hose connection G ½

9. Hansgrohe Raindance AIR 100 side showers

28477000 Raindance AIR 100 side showers G ½

10. Hansgrohe Raindrain XXL waste system

Floor drain (without shower tray): DN70 drain pipe Drain for shower tray:

60067000 Raindrain 90 XXL complete set

Drain capacity 51 l/min (damming height 15 mm) complies with DIN12056

Attention: The drain capacity must be greater than 50 l/min

11. Audio amplifier

The Hansgrohe RainBrain control panel provides a standard signal (L, R, Audio GND) with 0dBu level (0.775 V).

To complement the Hansgrohe RainBrain we recommend the Axor Starck loudspeakers (# 40874,-000) in combination with the DeToma A403 active module (www.detoma.com) or the DeToma Q 110 loudspeaker/amplifier set. DeToma products are available at specialised radio/TV retailers.

Power supply: 230 V/50 Hz socket

12. Lighting control set

For external lighting

Power supply: 230 V/50 Hz

direct connection

Maximum load: 500 W

Connection cable: 10 m long

27189000 Hansgrohe RainBrain lighting control set

13. Junction box for operating voltage

Function box, lighting control set (optional) and amplifier (optional) require a 230 V/50 Hz power supply.

Product overview



control panel pure chrome



control panel white chrome

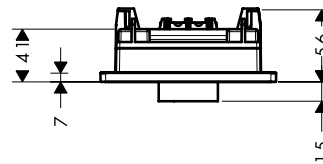
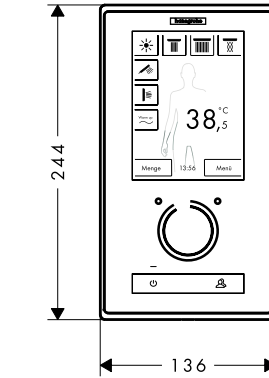

Function box

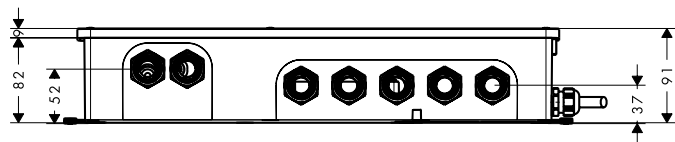

RainBrain finish set with water flow control,
 consisting of control panel with TouchScreen user interface, function box with electronic temperature control, water flow control, 5 magnetic valves and electronic control system (power supply 230 V/50 Hz)
 pure chrome # 15842000
 white chrome # 15842400

RainBrain finish set without water flow control,
 consisting of control panel with TouchScreen user interface, function box with electronic temperature control, 5 magnetic valves and electronic control system (power supply 230 V/50 Hz)
 pure chrome # 15841000
 white chrome # 15841400

to be combined with:
 RainBrain basic set
 # 15840180
 Lighting control set
 # 27189000

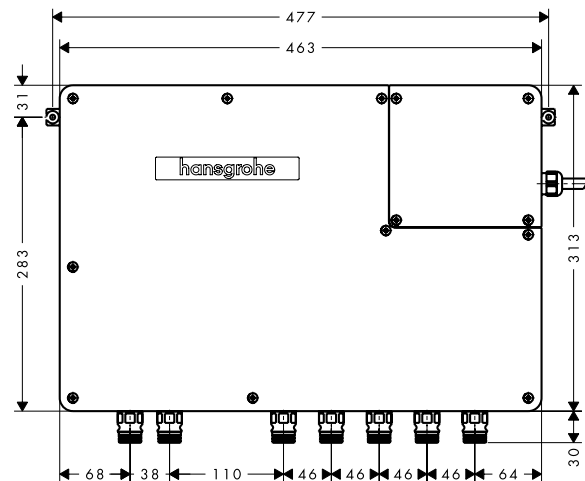

all dimensions in mm

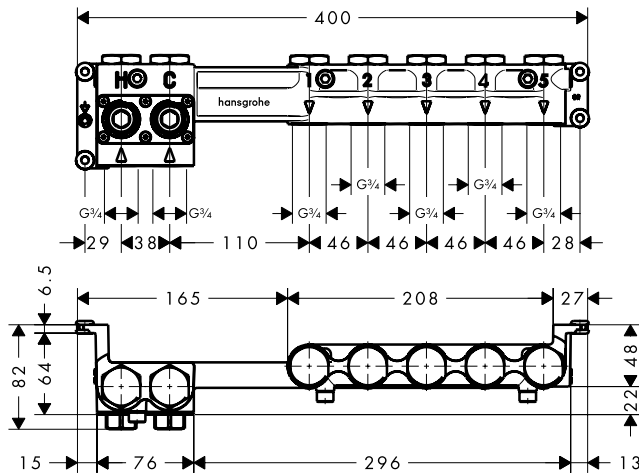
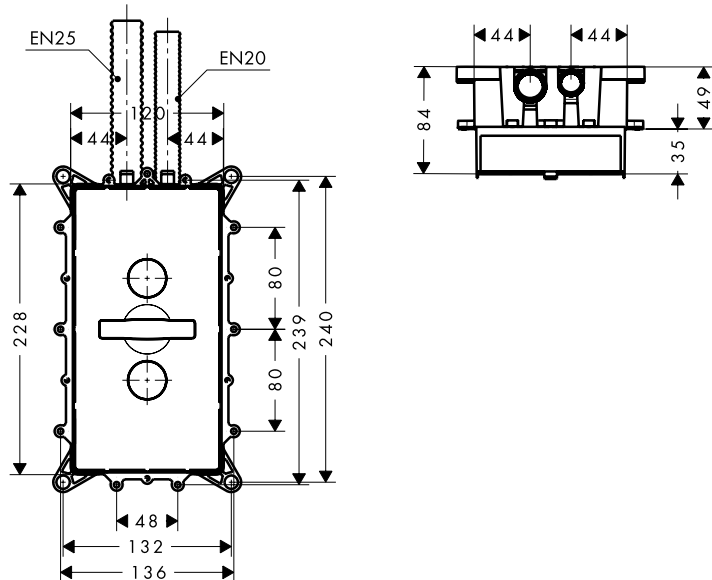

RainBrain basic set,

consisting of installation housing for the control panel, connection block with integrated shut-off device and dirt filter for G $\frac{3}{4}$ hot/cold water feed pipes, 5 x G $\frac{3}{4}$ connections for the showers and quick connectors for mounting the installation box, 7 m \varnothing 25 mm PE empty conduit for the control cable from control panel to installation box, 7 m \varnothing 20 mm PE empty conduit for audio cable
15840180

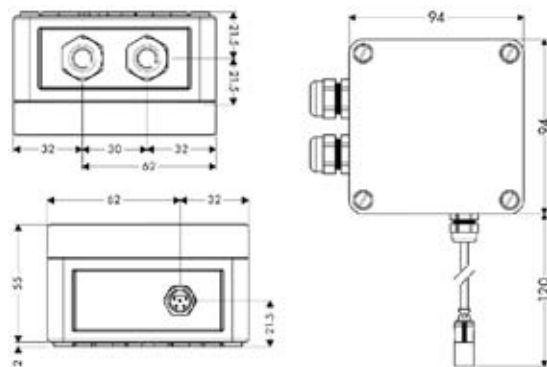

RainBrain Lighting control set

Power supply: 230 V/50 Hz Maximum load: 500 W
consisting of relay lighting control, 7 m connection cable
27189000

all dimensions in mm

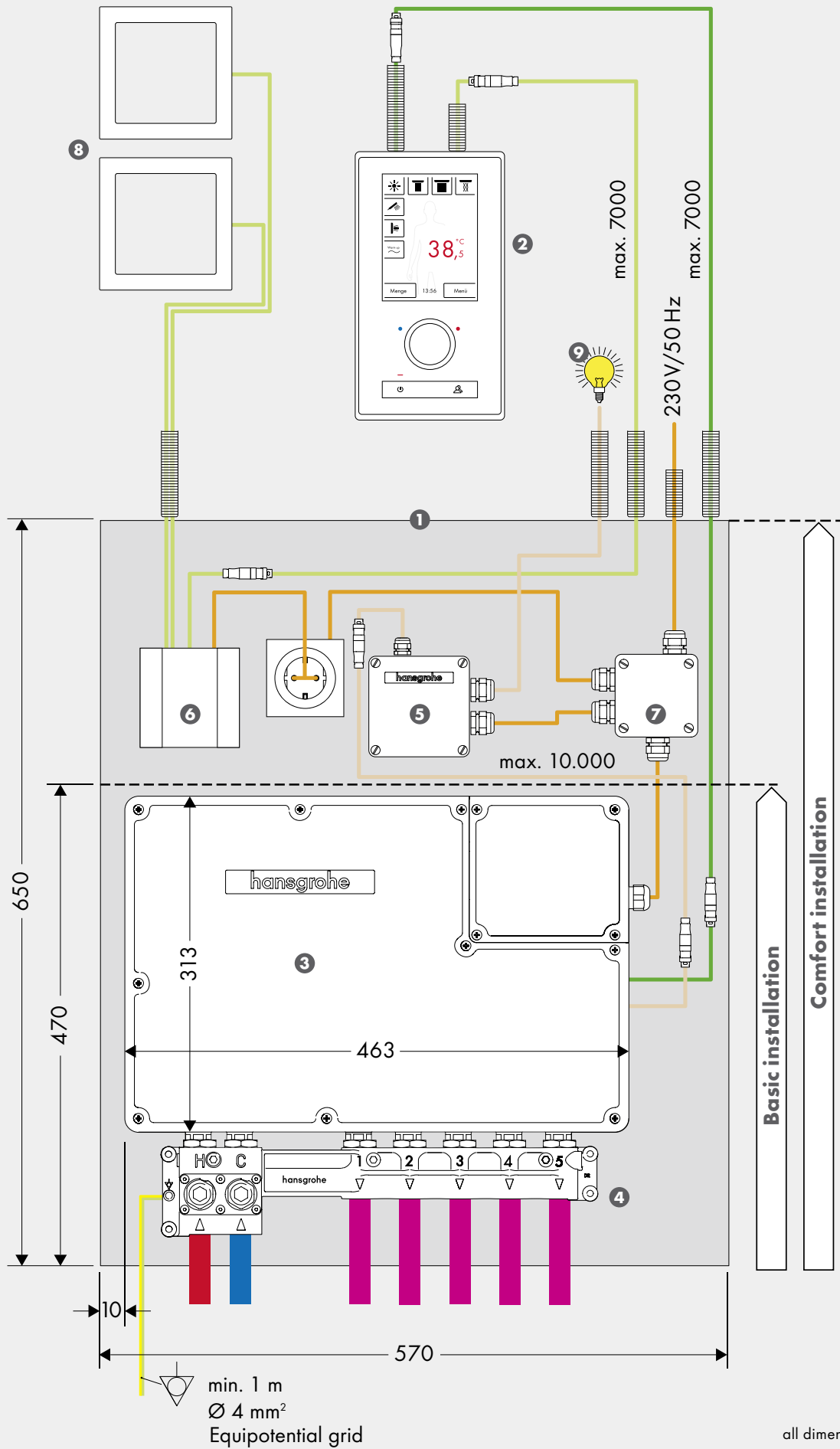

The RainBrain® function box: technical specifications

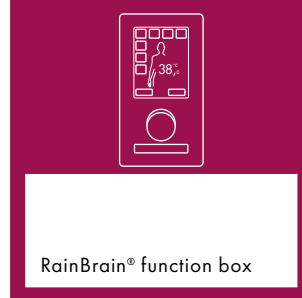

The core of the Hansgrohe RainBrain is the function box. It houses the electronic temperature control, water volume control, five magnetic valves to control the shower functions, a power supply unit and the electronic control system. The function box with its connecting bridge can be installed either directly onto the wall or in a designated installation space. The installation of the function box must be carried out within safety zone two. It is also necessary to ensure that the function box is left accessible for maintenance.

1. Installation space

Basic installation:
450 mm x 570 mm x 95 mm
Comfort installation:
650 mm x 570 mm x 95 mm

2. Control panel with installation housing

Dimensions: 136 mm x 244 mm
Installation depth: 84 mm

3. Function box

Dimensions: 463 mm x 313 mm
Installation depth: 83 mm
Power supply: 230 V/50 Hz

4. Connecting bridge

Dimensions: 400 mm x 96 mm
Installation depth: 83 mm

5. Lighting control set*

Dimensions: 94 mm x 94 mm
Installation depth: 57 mm
Power supply: 230 V/50 Hz

6. Audio amplifier*

Model: DeToma
Dimensions: 90 mm x 90 mm
Installation depth: 90 mm
Power supply: 230 V/50 Hz

7. Junction box for operating voltage*

Dimensions: 75 mm x 75 mm
Installation depth: 57 mm
Power supply: 230 V/50 Hz

8. Loud speakers*

9. Lighting*

* These products are not included in delivery.

Hansgrohe overhead showers and shower systems combine design excellence with technologies that make our products the most innovative on the market. This brochure offers you all the relevant information for the planning and installation of the shower systems presented here: measurements, flow rate charts, planning and installation instructions as well as mounting tips from our technicians.

We did our utmost to ensure that the printing of this brochure was friendly to the environment. By using a new kind of paper we were able to reduce the CO₂ emissions for the production process by more than thirty percent. You too can contribute to the protection of our environment by passing on the brochure to others when you've finished reading it, or by recycling it.

To find out more, please visit
www.hansgrohe-int.com



Argentina – Hansgrohe S.A. · Av. del Libertador 14.323 · Martínez · B1640APB · Buenos Aires
 Tel. +54 11 4733 2400 · Fax +54 11 4733 2499 · info@hansgrohe.com.ar · www.hansgrohe.com.ar

Headquarter – Hansgrohe AG · P.O. Box 1145 · D-77757 Schiltach
 Tel. +49 7836 51-0 · Fax +49 7836 51-1300 · info@hansgrohe.com · www.hansgrohe.com

India – Hansgrohe India (pvt.) Ltd. · Office Nos. 601 - 604 · Sky Station · Viman Nagar · 411 016 Pune · Maharashtra · India
 Tel. +91 20 6625 9595 · info@hansgrohe.in · www.hansgrohe.in

Mexico – Hansgrohe · Col. Lomas de Santa Fe · 01210 México, D.F. · Tel. +52 55 5261-4191 · Fax +52 55 5261-4199
info@hansgrohe.com.mx · www.hansgrohe.com.mx

South Africa – Hansgrohe South Africa (Pty) Ltd. · P.O. Box 2912 · 136 Walton Road
 Carlswald Midrand · ZA-1685 Halfway House · Tel. +27 11 468 11-50 · Fax +27 11 468 11-52
sales@hansgrohe.co.za · www.hansgrohe.co.za

